

GL7000

DATA PLATFORM

USER'S MANUAL

MANUAL NO.GL7000-UM-154

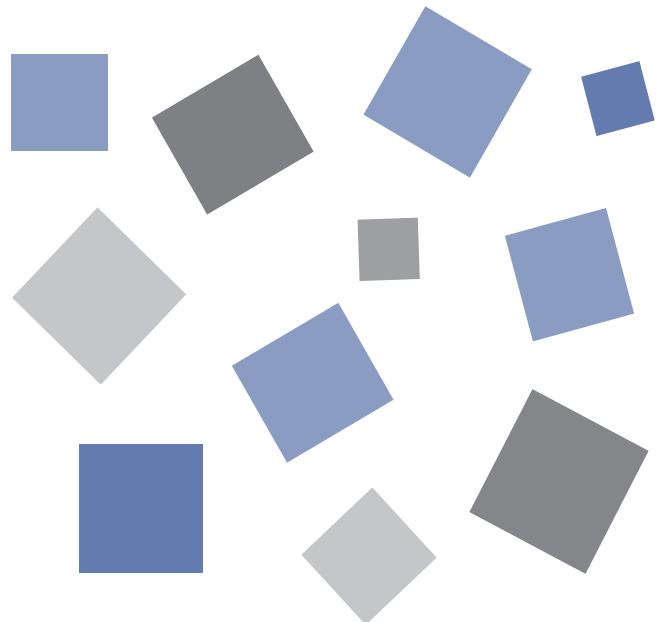





GRAPHTEC

To Ensure Safe and Correct Use









- To ensure safe and correct use of the GL7000, read this Manual thoroughly before use.
- After having read this Manual, keep it in a handy location for quick reference as needed.
- Do not permit small children to touch the GL7000.
- The following describes important points for safe operation. Please be sure to observe them strictly.

Conventions Used in This Manual

To promote safe and accurate use of the GL7000 as well as to prevent human injury and property damage, safety precautions provided in this manual are ranked into the five categories described below. Be sure you understand the difference between each of the categories.

| | |
|---|---|
|  DANGER | This category provides information that, if ignored, is highly likely to cause fatal or serious injury to the operator. |
|  WARNING | This category provides information that, if ignored, is likely to cause fatal or serious injury to the operator. |
|  CAUTION | This category provides information that, if ignored, could cause physical damage to the GL7000. |
|  HIGH TEMPERATURE | This category provides information that, if ignored, is likely to cause burns or other injury to the operator due to contact with high temperature. |
|  ELECTRICAL SHOCK | This category provides information that, if ignored, is likely to expose the operator to electrical shock. |

Description of Safety Symbols

| | |
|---|---|
|  | The  symbol indicates information that requires careful attention (which includes warnings). The point requiring attention is described by an illustration or text within or next to the  symbol. |
|  | The  symbol indicates action that is prohibited. Such prohibited action is described by an illustration or text within or next to the  symbol. |
|  |  The symbol indicates action that must be performed. Such imperative action is described by an illustration or text within or next to the  symbol. |

Safety Precautions

⚠ WARNING

Be sure to securely connect the GL7000's power cord.

- After checking that the Power switch is turned off, connect the power cord's female plug to the GL7000 and then connect its male plug into the electrical socket.
- Use of the GL7000 without the power cord securely plugged into the electrical socket may result in electrical shock due to current leakage.
- Before running the GL7000, be sure to ground the protective ground terminal (Ⓧ) to avoid electrical shock and fire hazards. For grounding, use a ground wire with a diameter of at least 0.75 mm². When using the GL7000 in an environment where grounding is not possible, ensure that the voltage to be measured is no greater than 50 V (DC or rms).



Securely connect the power cord. Make sure that the socket has a good protective ground.

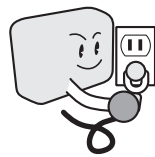

If the GL7000 generates smoke, is too hot, emits a strange odor, or otherwise functions abnormally, turn off its power and unplug its power cord from the electrical socket.

- Use of the GL7000 in such status may result in a fire hazard or electrical shock.
- After checking that smoke is no longer being generated, contact your sales representative or nearest Graphtec vendor to request repair.
- Never try to perform repair yourself. Repair work by inexperienced personnel is extremely dangerous.



Amateur repair prohibited

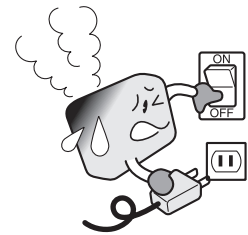

Before turning on the GL7000, ensure that the electric socket's supply voltage conforms to the GL7000's power rating.

- Use of a different supply voltage may cause damage to the GL7000 or a fire hazard due to electrical shock or current leakage.



Amateur repair prohibited



Never disassemble or remodel the GL7000.

- Such action may cause a fire hazard due to electric shock or current leakage.
- Contact with a high-voltage component inside the GL7000 may cause electric shock.
- If repair is required, contact your sales representative or nearest Graphtec vendor.



No disassembly



Avoid using the GL7000 in extremely dusty or humid places.

- Such use may cause a fire hazard due to electrical shock or current leakage.



Use prohibited



Watch out for electrical shock

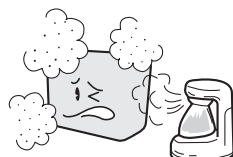

Avoid using the GL7000 in places where it may be exposed to water such as bathrooms, locations exposed to wind and rain, and so on.



Avoid water



Watch out for electrical shock

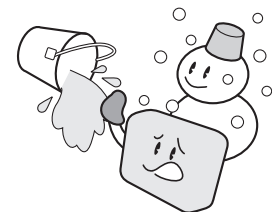

Prevent dust or metallic matter from adhering to the power supply connector.

- Adhesion of foreign matter may cause a fire hazard due to electrical shock or current leakage.



No foreign matter



Watch out for electrical shock

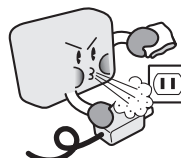

Never use a damaged power cord.

- Use of a damaged cord may result in a fire hazard due to electrical shock.
- If the cord becomes damaged, order a new one to replace it.



Unplug the power cord from the socket



Safety Precautions

⚠ CAUTION

Do not use or store the label printer in a location exposed to direct sunlight or the direct draft of an air conditioner or heater.

- Such location may impair the GL7000's performance.



Storage/Use prohibited

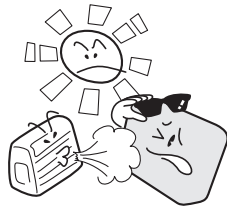

Do not place coffee cups or other receptacles containing fluid on the GL7000.

- Fluid spilling inside the GL7000 may cause a fire hazard due to electrical shock or current leakage.



Avoid water



Watch out electrical shock



Do not use the GL7000 in a location subject to excessive mechanical vibration or electrical noise.

- Such location may impair the GL7000's performance.



Use prohibited

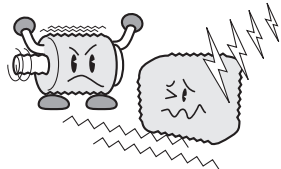

To insert or disconnect the power cord or a signal input cable, grasp the power cord's plug or the signal input cable's connector.

- Pulling the cord/cable itself damages the cord/cable, resulting in a fire hazard or electrical shock.



No pulling

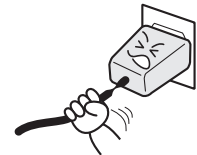

If fluid or foreign matters enters inside the GL7000, turn off the Power switch and disconnect the power cord from the electrical socket.

- Use in such status may cause a fire hazard due to electrical shock or current leakage.
- Contact your sales representative or nearest Graphtec vendor to request repair.



Unplug the power cord from the socket

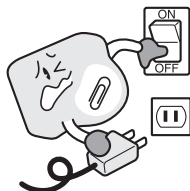

Do not input voltage that exceeds the permissible input voltage range that is specified on the GL7000's label.

- Exceeding the specified voltage input range may cause electrical shock or a fire hazard.



Use prohibited

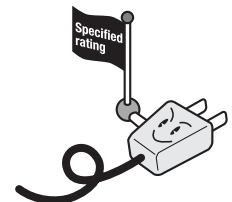

Do not attempt to lubricate the GL7000's mechanisms.

- Such action may cause the GL7000 to break down.



No lubrication

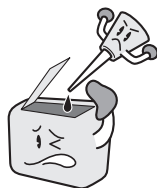

Never clean the GL7000 using a volatile solvent (such as thinner or benzene).

- Such action may impair the GL7000's performance.
- Clean off any soiled areas using a soft dry cloth.



No volatile solvent



To ensure safe and correct use of your GL7000, read this manual thoroughly before use.

If the equipment is used in a manner not specified by the manufacture, the protection provided by the equipment may be impaired.

Introduction

Thank you for purchasing the GL7000 DATA PLATFORM.

Please read this manual thoroughly before attempting to use your new product to ensure that you use it correctly and to its full potential.

Notes on Use

Be sure to read all of the following notes before attempting to use the GL7000 DATA PLATFORM.

1. Note on the CE Marking

The GL7000 complies with the EN61326 (Class A) standard based on the EMC directive (2004/108/EC).

It also conforms to the EN61010-1 standard based on the LV directive (2006/95/EC).

Although the GL7000 complies with the above-mentioned standards, be sure to use it correctly in accordance with the instructions and notes provided in its User's Manual.

Moreover, use of the GL7000 by incorrect procedures may result in damage to the GL7000 or may invalidate its safeguards. Please confirm all of its notes regarding use and other related information to ensure correct use.

2. Warning

This is a Class A product according to the EMC directive. In a domestic environment, this product may cause radio interference or may be affected by radio interference to the extent that proper measurement cannot be performed.

3. Notes for Safe Operation

(1) In environments where there is a lot of noise or where the power supply is unstable, we recommend that you ground the GL7000.

(2) When a high-voltage signal cable has been connected to the main unit's analog signal input terminal, avoid touching the leads of the input terminal's signal cable to prevent electrical shock due to high voltage.

(3) Ensure that the GL7000's power source is positioned so that it can easily be disconnected.

4. Notes on Functions and Performance

(1) Be sure to connect the main unit to an AC power supply that conforms to the rated range.

Connection to a non-rated power supply may cause the main unit to overheat and break down.

(2) Do not block the vent on the main unit.

Continued operation with the vent blocked may cause the main unit to overheat and break down.

(3) To avoid malfunctions and other damage, avoid using the GL7000 in the following locations.

- Places exposed to high temperature and/or high humidity, such as in direct sunlight or near heating equipment. (Allowable temperature range: 0 to 45°C, Allowable humidity range: 5 to 85%R.H.)
- Locations subject to excessive salt spray or heavy fumes from corrosive gas or solvents.
- Excessively dusty locations.
- Locations subject to strong vibrations or shock.
- Locations subject to surge voltages and/or electromagnetic interference.

(4) If the main unit becomes soiled, wipe it off using a soft, dry cloth. Do not use the organic solvents (such as thinner or benzene).

(5) Do not use the GL7000 in the vicinity of other devices which are susceptible to electromagnetic interference.

Introduction

- (6) Measured results may not conform to the stated specifications if the GL7000 is used in an environment which is subject to strong electromagnetic interference.
- (7) Insofar as possible, position the GL7000 input signal cables away from any other cables which are likely to be affected by electromagnetic interference.
- (8) For stabilized measurement, allow the GL7000 to warm up for at least 30 minutes after turning it on.

About Registered Trademarks

- Microsoft and Windows are registered trademarks or trademarks of Microsoft Corporation in the U.S. and elsewhere.
- Other company names and product names included in this manual are registered trademarks or trademarks of their respective companies.

CONTENTS

| | |
|---|------------|
| To Ensure Safe and Correct Use | i |
| Safety Precautions | ii |
| Safety Precautions | iii |
| Introduction | I |
| Notes on Use | I |
| About Registered Trademarks | II |

CHAPTER 1 General Description

| | |
|---|------------|
| 1.1 Overview | 1-2 |
| 1.2 Features | 1-2 |
| 1.3 Operating Environment | 1-3 |
| Ambient Operating Conditions | 1-3 |
| Warming-up Before Use | 1-3 |
| Configuration When in Use | 1-4 |
| 1.4 Notes on Temperature Measurement (Optional) | 1-5 |
| 1.5 Notes on Using the Monitor | 1-5 |
| 1.6 Changing the Display Language | 1-6 |
| 1.7 Explanation of symbols used on the equipment | 1-6 |

CHAPTER 2 Checks and Preparation

| | |
|--|-------------|
| 2.1 Checking the Outer Casing | 2-2 |
| 2.2 Checking the Accessories | 2-2 |
| Standard Accessories | 2-2 |
| 2.3 Checking the Optional Modules | 2-2 |
| Optional Modules | 2-2 |
| 2.4 Checking the Optional Accessories | 2-3 |
| Optional Accessories | 2-3 |
| 2.5 Main module Nomenclature and Functions | 2-4 |
| 2.6 Module Nomenclature and Functions | 2-6 |
| Display Module (GL7-DISP): Optional | 2-6 |
| SSD Module (GL7-SSD): Optional | 2-8 |
| Voltage Module (GL7-V): Optional | 2-9 |
| High speed voltage Module (GL7-HSV): Optional | 2-10 |
| Voltage/Temperature Module (GL7-M): Optional | 2-11 |
| Logic/Pulse Module (GL7-L/P): Optional | 2-12 |
| High voltage Module (GL7-HV): Optional | 2-13 |
| DC Strain Module (GL7-DCB): Optional | 2-14 |
| Charge Module (GL7-CHA): Optional | 2-15 |
| Voltage Output Module (GL7-DCO): Optional | 2-16 |
| 2.7 Installing and removing the Module | 2-17 |
| Installing the Display Module (GL7-DISP: optional) and GL7000 | 2-17 |
| Installing the amplifier module for measurement (optional) and main module | 2-22 |
| 2.8 Installing | 2-26 |
| Installation location | 2-26 |
| How to install (GL7000 and amplifier module, etc.) | 2-27 |

| | | |
|-------------|---|-------------|
| 2.9 | Connecting the Power Cable and Turning on the Power | 2-28 |
| | When using AC power | 2-28 |
| | Connecting to the GND terminal | 2-29 |
| 2.10 | How to Connect to Analog Signal Input Terminal and Precautions | 2-30 |
| | (1) Voltage Module (GL7-V: Optional) | 2-30 |
| | (2) Voltage/Temperature Module (GL7-M: Optional) | 2-31 |
| | (3) High Speed Voltage Module (GL7-HSV: Optional) | 2-33 |
| | (4) Logic/Pulse Module (GL7-L/P: Optional) | 2-34 |
| | (5) High-voltage Module (GL7-HV: Optional) | 2-36 |
| | (6) DC Strain Module (GL7-DCB: Optional) | 2-37 |
| | (7) Charge Module (GL7-CHA): Optional | 2-42 |
| | (8) Voltage Output Module (GL7-DCO): Optional | 2-44 |
| 2.11 | Input/output Cable Connection for GL | 2-45 |
| | Internal equivalent circuit in input/output circuit | 2-46 |
| | GL input and output cabling | 2-46 |
| | REMOTE Functions | 2-47 |
| 2.12 | Noise Countermeasures | 2-48 |

CHAPTER 3 Measure and Set

| | | |
|------------|---|-------------|
| 3.1 | Nomenclature | 3-2 |
| | (1) Waveform + Digital Screen | 3-2 |
| | (2) HOME screen | 3-7 |
| | (3) Navigator | 3-9 |
| | (4) Menu screen | 3-10 |
| | (5) Settings screen | 3-11 |
| | (6) Menu tree | 3-13 |
| 3.2 | Touch-panel Functions | 3-22 |
| 3.3 | Explanation of the Common Process Screens | 3-24 |
| | (1) Numerical entry | 3-24 |
| | (2) Enter a character | 3-26 |
| | (3) File operations | 3-28 |
| 3.4 | Key Operations | 3-39 |
| 3.5 | Description of Each Operating Mode | 3-44 |
| 3.6 | Explanation of the Settings Menu | 3-48 |
| | (1) Record settings | 3-48 |
| | (2) Marker settings | 3-56 |
| | (3) Backup settings | 3-57 |
| | (4) Output settings | 3-58 |
| | (5) Trigger/Alarm settings | 3-64 |
| | (6) I/F, USB settings | 3-68 |
| | (7) IP settings | 3-69 |
| | (8) FTP server settings | 3-71 |
| | (9) Date/Time settings | 3-73 |
| | (10) Other settings | 3-75 |
| | (11) Input settings | 3-78 |
| | (12) Trigger level settings | 3-105 |
| | (13) Alarm level settings | 3-110 |
| | (14) Waveform setting (Simple Waveform Setting) | 3-112 |
| | (15) Display settings | 3-114 |
| | (16) Replay setting screen (Data relaying screen) | 3-129 |

| | |
|--|--------------|
| (17) File operations | 3-129 |
| (18) Data Save | 3-130 |
| (19) Save/Load current settings | 3-132 |
| (20) Swapping out the SD card | 3-134 |
| (21) Screenshot | 3-136 |
| (22) Cursor position | 3-137 |
| (23) Data search | 3-139 |
| (24) Action screen | 3-141 |
| (25) Statistical calculation | 3-142 |
| (26) Data with CSV format | 3-143 |
| (27) Output settings (DCO module settings) | 3-144 |
| 3.7 Web server functions | 3-146 |

CHAPTER 4 Specification

| | |
|---|-------------|
| 4.1 Standard Specifications | 4-2 |
| Standard Specifications | 4-2 |
| Internal memory devices | 4-3 |
| PC I/F | 4-3 |
| 4.2 Function Specifications | 4-4 |
| Data recording functions | 4-4 |
| Trigger and Alarm functions | 4-5 |
| Various functions | 4-6 |
| External Input/Output functions | 4-7 |
| Synchronization function | 4-7 |
| 4.3 Function Module Specifications | 4-8 |
| Display Module (GL-DISP: optional) | 4-8 |
| SSD Module (GL7-SSD: optional) | 4-8 |
| 4.4 Amplifier Module Specifications | 4-9 |
| Voltage Module (For voltage measurement) (GL7-V: optional) | 4-9 |
| Voltage/Temperature Module (For temperature measurement) (GL7-M: optional) | 4-10 |
| High Speed Voltage Amplifier Module(For high speed voltage measurement) (GL7-HSV: optional) | 4-11 |
| Logic/Pulse Amplifier Module (Logic/Pulse) (GL7-L/P: optional) | 4-12 |
| High-voltage Module (For high-voltage measurements) (GL7-HV: optional) | 4-13 |
| DC Strain Module (For Strain/voltage/resistance measurement)(GL7-DCB: optional) | 4-15 |
| Charge Module (For Acceleration measurement)(GL7-CHA: optional) | 4-16 |
| Voltage Output Module (For output voltage measurement) (GL7-DCO: optional) | 4-17 |
| 4.5 Accessory/Option Specifications | 4-18 |
| Control software (GL-Connection) | 4-18 |
| Standard accessories | 4-18 |
| Humidity sensor: B-530 (optional) | 4-19 |
| 4.6 Accessories | 4-20 |
| Optional Accessories | 4-20 |
| 4.7 External view | 4-21 |
| INDEX | I-1 |

CHAPTER 1 General Description

This chapter provides a general description of the GL7000 and its features.

- 1.1 Overview
- 1.2 Features
- 1.3 Operating Environment
- 1.4 Notes on Temperature Measurement (Optional)
- 1.5 Notes on Using the Monitor
- 1.6 Changing the Display Language
- 1.7 Explanation of symbols used on the equipment

1.1 Overview

The GL7000 is a module-expanding, high speed, multi-function, multi-channel DATA PLATFORM. A maximum of 10 Amplifier Modules can be expanded, and expansion of an SSD Module and a Display Module makes it suitable for all sorts of needs.

In addition to being able to record measuring data on the built-in RAM, it also comes equipped with a large capacity flash memory. Since recording can be done to an SD card, transferring data to the PC when offline is easy. For the PC interface, as USB and Ethernet is included as standard, system configuration according to use is possible. As the Ethernet function is equipped with both a WEB server and an FTP server function, remote supervision and data transfer are also possible.

1.2 Features

Input

- In compliance with the diversity of the objects to be measured, an Amplifier Module where the amplifier can be selected has been adopted.

Display and operations

- In compliance with the diversity of the objects to be measured, an Amplifier Module where the amplifier can be selected has been introduced.
- It comes equipped with a high resolution 5.7" TFT color liquid crystal display.
- A capacitive touch-screen is adopted, and because of the easy-to-understand menu configuration operations can easily be carried out.
- By separately placing keys on the touch-screen, we've made it possible to carry out operations in environments where the touch-screen can't be used, such as when wearing gloves.

*: For when the optional Display Module is installed

Recording

- Data can be saved directly to the built-in flash memory and to an SD card.
- Data recorded in the built-in flash memory is retained even if the power is turned off.
- Because disk image can be used for the built-in flash memory, multiple data can be saved.
- High speed recording can be done by recording to the built-in RAM. After confirming the recorded data, if necessary, it can be saved to the built-in flash or an SD card.
- Because it comes equipped with a ring recording function, even if doing long time recordings, the latest data always remains.
- When recording to the built-in RAM, built-in flash memory, or an SD card, even if the number of modules is increased, the sampling rate will not go down.
- The SSD Module (optional) is provided. With high speed, large quantity (1 file of maximum 2GB) data can be recorded. (The sampling rate is restricted according to the number of connected modules.)

Data Control & Processing

- The application software provided lets you set conditions and monitor data on a computer.
- The USB drive mode function enables the main module's flash memory to be recognized as an external drive by your PC. (Connect the main module to your PC and turn on the power supply to the main module while holding down the [START] key.)
- Captured data can be read from the application software to files and displayed for processing.
- Data can be transferred off-line to a computer using USB memory.
- Depending on the WEB Server function, remote management and supervision can be possible without using the dedicated software.
- With the FTP server function, you can operate the built-in flash memory and SD card on the PC.
- With the FTP client function, you can create a backup of the measured data to the FTP server.

1.3 Operating Environment

This section explains the operating environment for the main module.

Ambient Operating Conditions

- (1) Ambient temperature and humidity (the main module must be operated within the following ranges.)
 - Temperature range: 0 to 45°C
 - Humidity range: 5 to 85% RH
- (2) Environment (do not install in the following locations.)
 - Outdoor
 - A Location such as being exposed to direct sunlight
 - Locations exposed to salty air, corrosive gases, or organic solvents
 - Dusty locations
 - Locations subject to vibration or impact
 - Locations subject to voltage surge or electromagnetic interference such as lightning or electric furnaces
- (3) Installation category (overvoltage category)
 - The main module belongs to Installation Category II defined in IEC60664-1.
 - Never use the main module for Installation Category III or IV.
- (4) Measurement category
 - The GL7000 main module is not available in the Measurement Category II, III, IV defined in IEC61010. (The high-voltage module belongs to Measurement Category II.)
- (5) Altitude
 - Altitude up to 2000 m.
- (6) Mains supply voltage
 - 100 to 240 V AC $\pm 10\%$
- (7) POLLUTION DEGREE
 - POLLUTION DEGREE 2 in accordance with IEC 664.
- (8) Intended use
 - This product intends the industrial equipment usage of Measurement for research of development or Measurement of factory line.

CHECKPOINT

If condensation occurs...

Condensation occurs in the form of water droplets on the device surfaces and interior when the GL7000 is moved from a cold to a warm location. Using the GL7000 with condensation will cause malfunctioning.

Wait until the condensation has disappeared before turning on the power.

Warming-up Before Use

The main module should be allowed to warm up with the power turned on for approximately 30 minutes to ensure that it operates according to the specified performance.

Configuration When in Use

It is recommended to use the main module while it is laid flat or inclined on the stands.

< Usage Configuration >

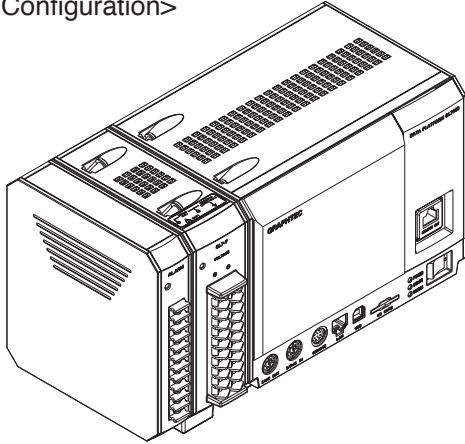

⚠ CAUTION

- To prevent possible malfunction, do not block the air vents of the main module.
 - If you use the main module in other position than described in the above, the measurement accuracy may not meet the specifications.
-

1.4 Notes on Temperature Measurement (Optional)

* When installing optional Voltage/Temperature Module.

Please observe the following precautions when performing temperature measurement.

- Do not block the air vents. Always provide a space of at least 20 cm on all sides of the main module.
- For stabilized temperature measurement, allow the main module to warm up for at least 30 minutes after turning it on.
- Exposure of the input terminals to direct drafts, direct sunlight, or abrupt changes in temperature may impair the equilibrium of the input parts and result in measurement errors. To measure temperature in such an environment, take appropriate countermeasures such as changing the installation site of the main module.
- If you measure in the place where there is a lot of noise, be sure to make a ground connection to the GND terminal on the module (Refer to page 2-48).
- If measured values fluctuate due to noise, slow down the sampling interval (Refer to page 3-49).

1.5 Notes on Using the Monitor

* When installing optional Display Module.

The monitor is an LCD display unit, and so the display will vary depending on the operating environment.

CHECKPOINT

If the screen saver function is used, it will operate and clear the screen if no operations are performed during the preset time. If the screen saver operates, press any key to restore the display.

CAUTION





- Condensation may form on the LCD screen if the GL7000 is moved from a cold to a warm location. If this occurs, wait until the LCD screen warms up to room temperature.
 - The LCD screen is manufactured to extremely high precision. Black dots may appear, or red, blue, and green dots may not disappear. Likewise, streaks may appear when viewed from certain angles. These phenomena are due to the LCD screen construction, and are not signs of a fault.
-

1.6 Changing the Display Language

* When installing optional Display Module.

You can choose either English, Japanese, French, German, Chinese, or Korean as the language displayed on the screen. The default display language is set to English when the main module is shipped overseas. To change the display language, see the instructions in "OTHR:Language".

1.7 Explanation of symbols used on the equipment

| Symbols | Meaning | Display locations | Descriptions |
|---|-------------------------------------|--|---|
|  | Caution (Refer to Manual) | <ul style="list-style-type: none"> • Front panel of Main module. • Right side panel of Main module. • Front panel of Alarm Output Module • In the label seal of top panel on each measurement module (optional). | <ul style="list-style-type: none"> • Avoid touching the input terminals and leads of the input terminal's signal cable to prevent electrical shock due to high voltage. • If a voltage exceeding the specified value is input, the main unit will be damaged. • Install the specified cable to each I/F connector. |
|  | Earth (Ground) Terminal | <ul style="list-style-type: none"> • In the label seal of top panel on each measurement modules (optional). | <ul style="list-style-type: none"> • If the measured value is unstable due to the exogenous noise, it is probably better that the cables are thicker between the GND terminal of DUT and the GND terminal of GL7000. In addition, the both GND terminals should be connected to the earth for same potential level. • If a voltage exceeding the specified value is input, the main unit will be damaged. |
|  | Alternating current | <ul style="list-style-type: none"> • In product identification label of right side on the main unit. | <ul style="list-style-type: none"> • Be sure to connect the main unit to an AC power supply that conforms to the rated range. Connection to a non-rated power supply may cause the main unit to overheat and break down. • Be careful to electric shock. |
|  | PROTECTIVE CONDUCTOR TERMINAL | <ul style="list-style-type: none"> • Right side panel of the main unit. | <ul style="list-style-type: none"> • Make sure that the main unit is grounded. • If the main unit is not grounded, the operator could suffer an electrical shock in case of current leakage. • Be sure to ground the grounding cable from the power connector. |

CHAPTER 2 Checks and Preparation

This chapter explains how to check the main module's external casing and accessories, and how to prepare the main module for operation.

- 2.1 Checking the Outer Casing
- 2.2 Checking the Accessories
- 2.3 Checking the Optional Modules
- 2.4 Checking the Optional Accessories
- 2.5 Main module Nomenclature and Functions
- 2.6 Module Nomenclature and Functions
- 2.7 Installing and removing the Module
- 2.8 Installing
- 2.9 Connecting the Power Cable and Turning on the Power
- 2.10 How to Connect to Analog Signal Input Terminal and Precautions
- 2.11 Input/output Cable Connection for GL
- 2.12 Noise Countermeasures

2.1 Checking the Outer Casing

After unpacking, check the GL7000's outer casing before use. In particular, please check for the following:

- Surface scratches
- Other flaws such as stains or dirt

2.2 Checking the Accessories

After unpacking, check that the following standard accessories are included.

Standard Accessories

| Item | Description | Quantity |
|-------------------|---|----------|
| Alarm Module | This is installed in the main module at shipping. | 1 |
| Quick Start Guide | GL7000-UM-85X | 1 |
| CD-ROM | User's Manual, Application software | 1 |
| Face cover | This is installed in the main module at shipping. | 1 |
| AC cable | | 1 |

2.3 Checking the Optional Modules

Optional Modules

| Item | Model | Description |
|----------------------------|----------|---|
| Display Module | GL7-DISP | 5.7-inch LCD, Touch-panel, Operation key |
| SSD Module | GL7-SSD | 64GB, SSD |
| Voltage Module | GL7-V | For voltage measurement |
| Voltage/temperature Module | GL7-M | For voltage/temperature measurement |
| High-speed Voltage Module | GL7-HSV | For high-speed voltage measurement |
| Logic/Pulse Module | GL7-L/P | For logic/pulse measurement |
| High-voltage Module | GL7-HV | For high-voltage measurement |
| DC Strain Module | GL7-DCB | For Strain/voltage/resistance measurement |
| Charge Module | GL7-CHA | For Acceleration measurement |
| Voltage Output Module | GL7-DOC | For voltage output |

2.4 Checking the Optional Accessories

Optional Accessories

| Item | Model | Description |
|--|----------------|--|
| Sync cable for GL7000 | B-559 | Sync cable between devices |
| Probe for logic/pulse | RIC-10 | 4ch input (Set of alligator clip and IC clip) |
| BNC-BNC cable | RIC-112 | 1.5 m, 60VDC or less |
| BNC-Banana cable | RIC-113 | 1.5 m, 60VDC or less |
| BNC-Alligator cable | RIC-114 | 1.5 m, 60VDC or less |
| Safe probe | RIC-141A | 1:1 42pF, Length 1.2 m, 300VDC, CAT II |
| Insulated BNC-BNC cable | RIC-142 | Length 1.5 m, 1000 VDC, CAT II |
| Insulated BNC-Banana cable | RIC-143 | Length 1.6 m, 600 VDC, CAT II |
| Alligator clip (small) *2 | RIC-144A | Aperture: 11 mm, 300 VDC, CAT II, MAX15A |
| Alligator clip (Middle) *2 | RIC-145 | 20 mm, 1000 VDC, CAT III, MAX32A |
| Grabber Clips*2 | RIC-146 | Aperture: 5 mm, 1000 VDC, CAT III, MAX1A |
| Input/output cable for GL | B-513 | 2 m, Bare tips |
| Humidity sensor*1 | B-530 | 3 m, With a dedicated power connector |
| Humidity sensor power box | B-542 | Humidity sensor, 10-wiring, Built to order |
| M3 screws with flat washers | B-543 | 60 pcs. |
| Shunt resistance 250Ω | B-551 | 250Ω, Rated power of 1W, Maximum service voltage of 15.8 V, Built to order |
| DSUB-Screw terminals conversion connector | B-560 | DSUB connecting conversion connector for DC Strain Module |
| DSUB-NDIS conversion cable | B-561 | DSUB-NDIS conversion cable for DC Strain Module only |
| SMA-BNC conversion cable | B-562 | SMA-BNC conversion cable (2 m) for Voltage Output Module |
| Extra fine K-type thermocouple (TC200/TD1000), 5 per set | ST-55K-TC-1.2M | Tip wire \varnothing 0.127, 0.5 x 0.7 x 200 mm, Relay section 1 m, 5 per set |
| Needle-shape K-type thermocouple | RIC-410 | -100 to 300°C, Class 1, Cord length: 1.1 m |
| Stationery-surface K-type thermocouple | RIC-420 | -30 to 400°C, Class 2, Cord length: 1.1 m |
| L-type stationery-surface K-type thermocouple | RIC-430 | -30 to 600°C, Class 2, Cord length: 1.1 m |

*1: Allowable temperature range: -25 to +80°C

*2: One each for red and black, Connect to RIC-143

2.5 Main module Nomenclature and Functions

This section describes the names and function of parts of the main module (Separately, an optional amplifier module is needed).

The Alarm module has been connected to the GL7000 main module at shipping.

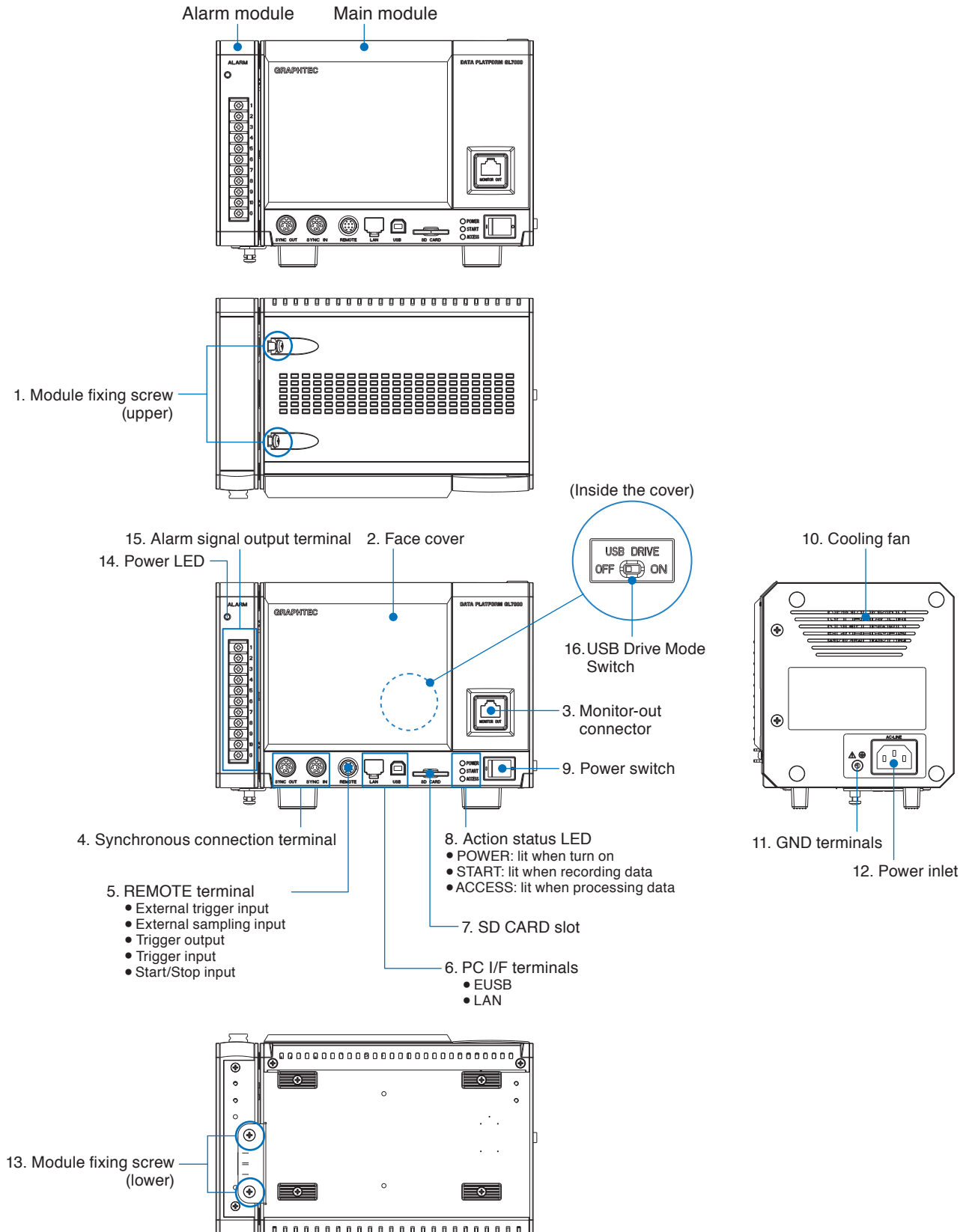

1. Module fixing screw (upper) Fixation screw for the adjoining module.
To prevent drop off, please refrain from removing it from the module.
2. Face cover..... Remove when the Display Module (optional) is mounted on the main module.
3. Monitor-out connector Connector for connecting the Display Module (optional).
(When using the tilting table and when extending the cable)
4. Synchronous connection terminal
..... Using the GL7000 sync cable (optional), the multiple GL7000 main modules are synchronized.
(Synchronization function is available in GL-Connection only.)
5. REMOTE terminal Manages the main module when using input cable for GL (optional).
6. PC I/F terminals..... Performs communications between the main module and PC (application) when using a USB/LAN cable.
7. SD CARD slot For inserting an SD CARD.
8. Action status LED Displays a light according to every action.
9. Power switch Turns the power On/Off for every module.
10. Cooling fan Cools the main module.
11. GND terminals Terminal for grounding.
12. Power inlet..... Connects the attached AC cable.
13. Module fixing screw (lower) Fixation screw for the adjoining module.
14. Power LED..... Lights up green when the power is turned on and the Alarm Module is recognized.
15. Alarm signal output terminal... Terminal for outputting the alarm signal.
16. USB Drive Mode switch..... By turning on, it goes into USB Drive Mode. In USB Drive Mode, you can see the built-in flash memory, SD card, or extended SSD as an external storage device on the computer. Since these are recognized as a removable disk, it is easy to transfer and delete the files.

2.6 Module Nomenclature and Functions

This section describes the names and function of parts of the Module.

⚠ CAUTION

- When installing or removing modules, please make sure that the power is turned off.
- Adequate precautions against static electricity must be taken when handling the modules.
- After installation, please make sure to tighten the screws. If using without tightening the screws, the module may break off during use.

Display Module (GL7-DISP): Optional

⚠ CAUTION

- Since the touch-panel in this module is a capacitive touch-panel, it does not respond by touching it with a pen. Touch the finger without glove.
- Adequate precautions against static electricity must be taken when handling the modules. Please note that if the touch-panel is operated with an object with a sharp edge, it may scratch and damage the touch-panel.
- Do not touch when your hands are wet.

<Display module (GL7-DISP) set contents>

- Display module : 1 module
- Tilting table : 1 module
- Monitor connection cable (40 cm) : 1 pc.
- Screws (M4x6) : 3 pcs.
- Ground cable : 1 pc.
- Flat Head Screws (M4x10) : 2 pcs. (Spare)

Display Module

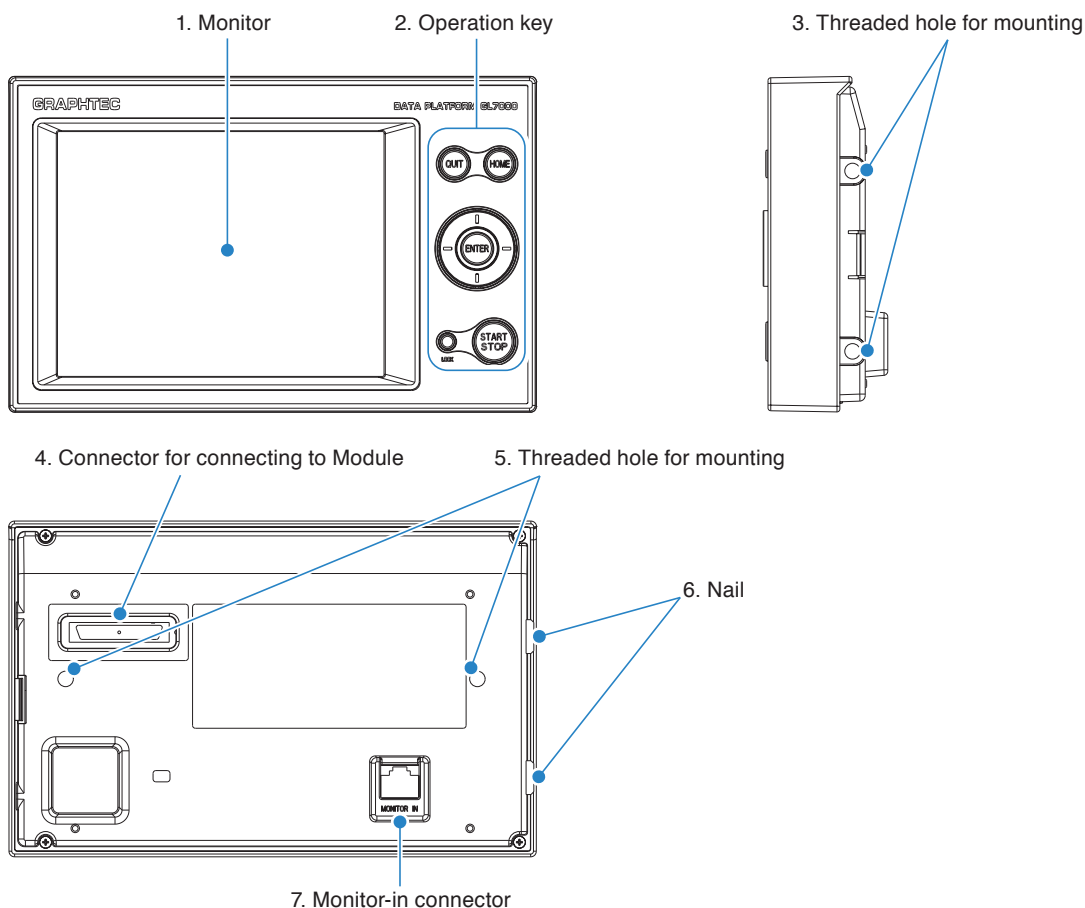

1. Monitor.....LCD monitor equipped with a touch-panel function.
2. Operation keyKey operation is performed on the screen.
 * Almost all operations can be performed on the touch-panel or from operation key.
3. Threaded hole for mountingThreaded hole for fixing to the main module.
4. Connector for connecting to Module
Connector for connecting to the main module.
5. Threaded hole for mountingThreaded hole for fixing to the tilting table (2 places).
6. NailNails for fixing to the main module (2 places).
7. Monitor-in connectorConnector for use when extending cable, and when using the tilting table.

Tilting table

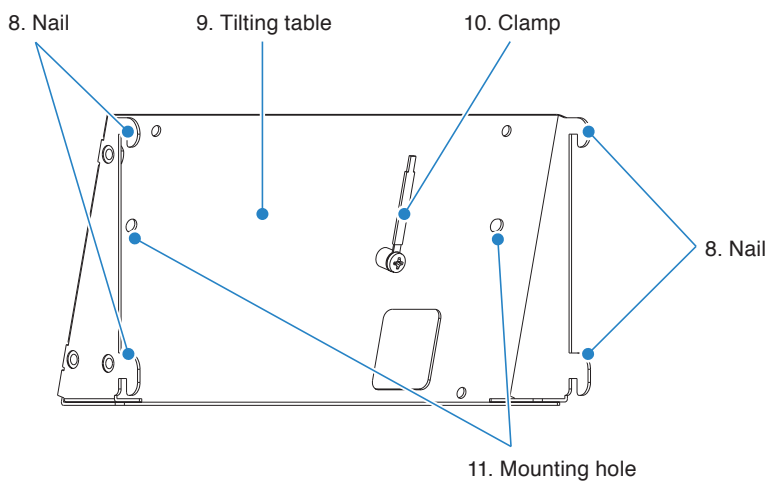

8. NailNails for fixing to the main module (4 places).
9. Tilting tableUse the tilting table (at a 15° tilt angle) to fit the Display Module to main module.
10. ClampClamp for binding the monitor connection cable.
11. Mounting holeThreaded hole for fixing to the Display Module.

SSD Module (GL7-SSD): Optional

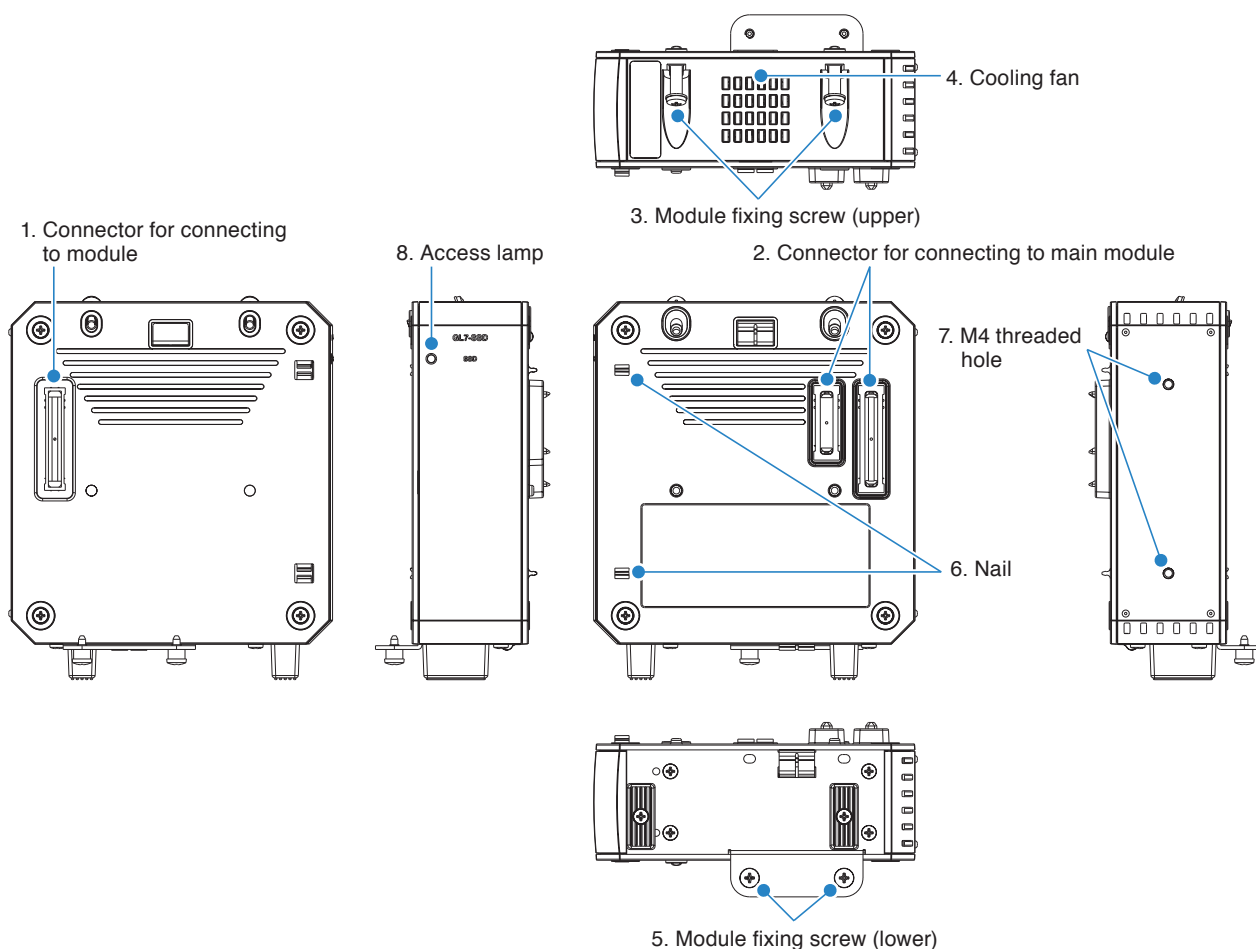

1. Connector for connecting to module
Connector for connecting to the various modules.
2. Connector for connecting to main module
Connector for connecting to the main module.
3. Module fixing screw (upper)Fixation screw for the adjoining module.
 To prevent drop off, please refrain from removing it from the module.
4. Cooling fanFan to cool internally.
5. Module fixing screw (lower).....Fixation screw for the adjoining module.
6. Nail A nail for aiding in positioning when connecting the module.
7. M4 threaded hole.....Use this hole to mount to the panel, etc.
8. Access lampDuring data access, it lights up green (not lit when normal operation).
 * Do not turn of the power during the lamp is lit.

Voltage Module (GL7-V): Optional

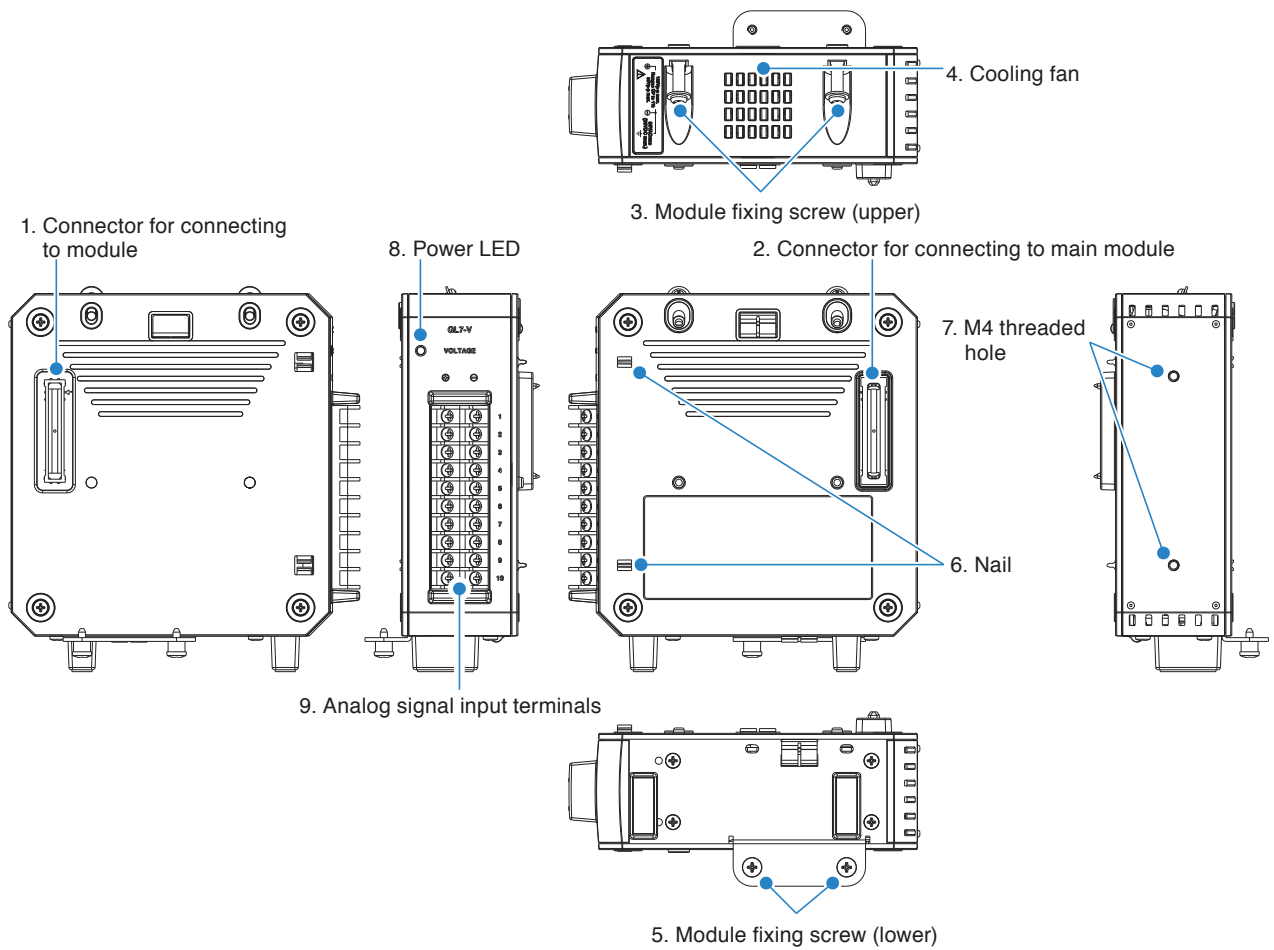

1. Connector for connecting to moduleConnector for connecting to the various modules.
2. Connector for connecting to main moduleConnector for connecting to the GL7000 main module or various modules.
3. Module fixing screw (upper)Fixation screw for the adjoining module.
4. Cooling fanFan to cool internally.
5. Module fixing screw (lower)Fixation screw for the adjoining module.
6. NailA nail for aiding in positioning when connecting the module.
7. M4 threaded holeUse this hole to mount to the panel, etc.
8. Power LEDThe Power LED will light up green when the power has been turned on and the module has been recognized.
9. Analog signal input terminals ...Terminal for inputting analog measurements.

High speed voltage Module (GL7-HSV): Optional

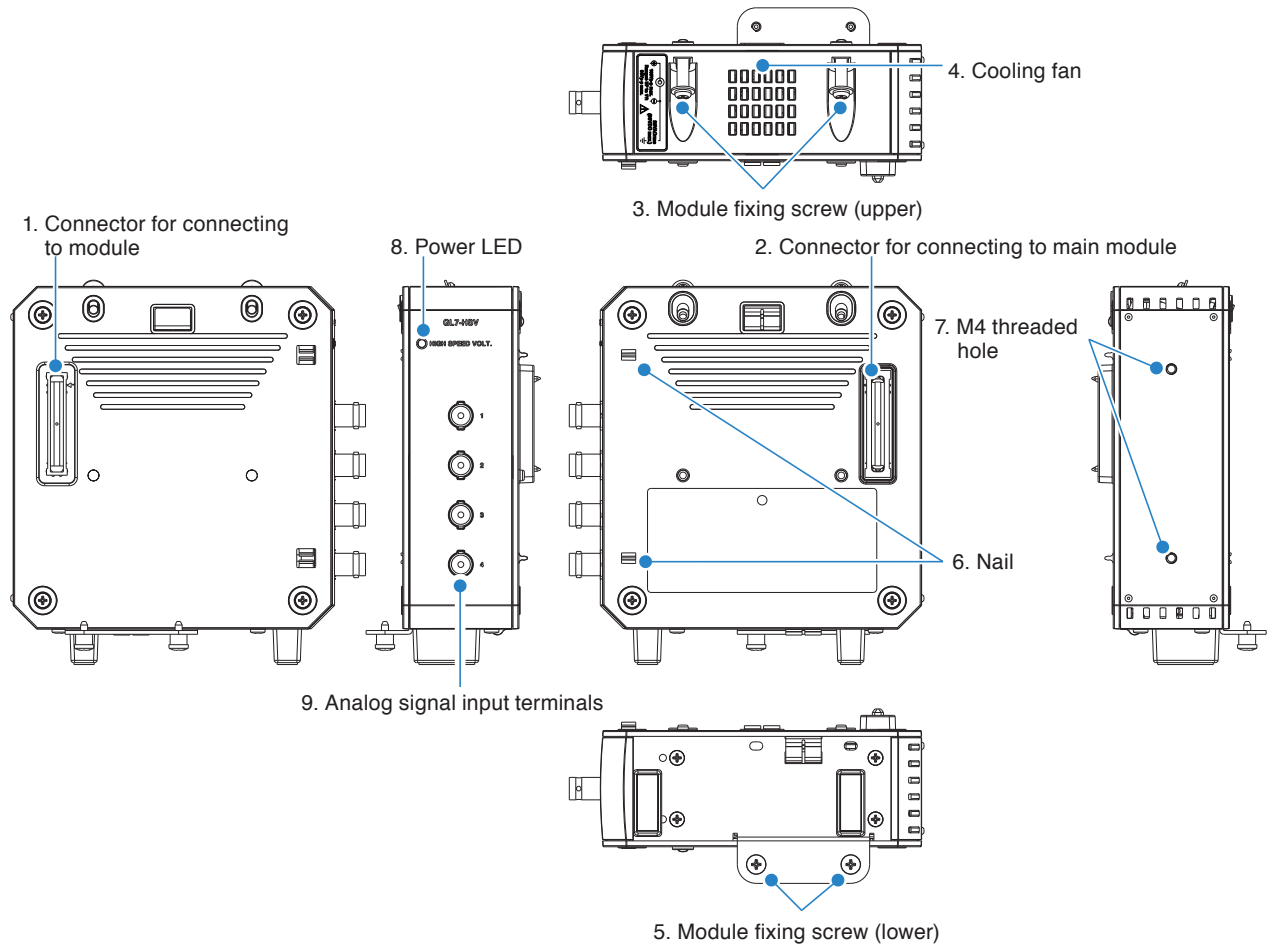

1. Connector for connecting to module
.....Connector for connecting to the various modules.
2. Connector for connecting to main module
.....Connector for connecting to the GL7000 main module or various modules.
3. Module fixing screw (upper)Fixation screw for the adjoining module.
4. Cooling fanFan to cool internally.
5. Module fixing screw (lower).....Fixation screw for the adjoining module.
6. NailA nail for aiding in positioning when connecting the module.
7. M4 threaded hole.....Use this hole to mount to the panel, etc.
8. Power LEDThe Power LED will light up green when the power has been turned on and the module has been recognized.
9. Analog signal input terminals ...Terminal for inputting analog measurements.

Voltage/Temperature Module (GL7-M): Optional

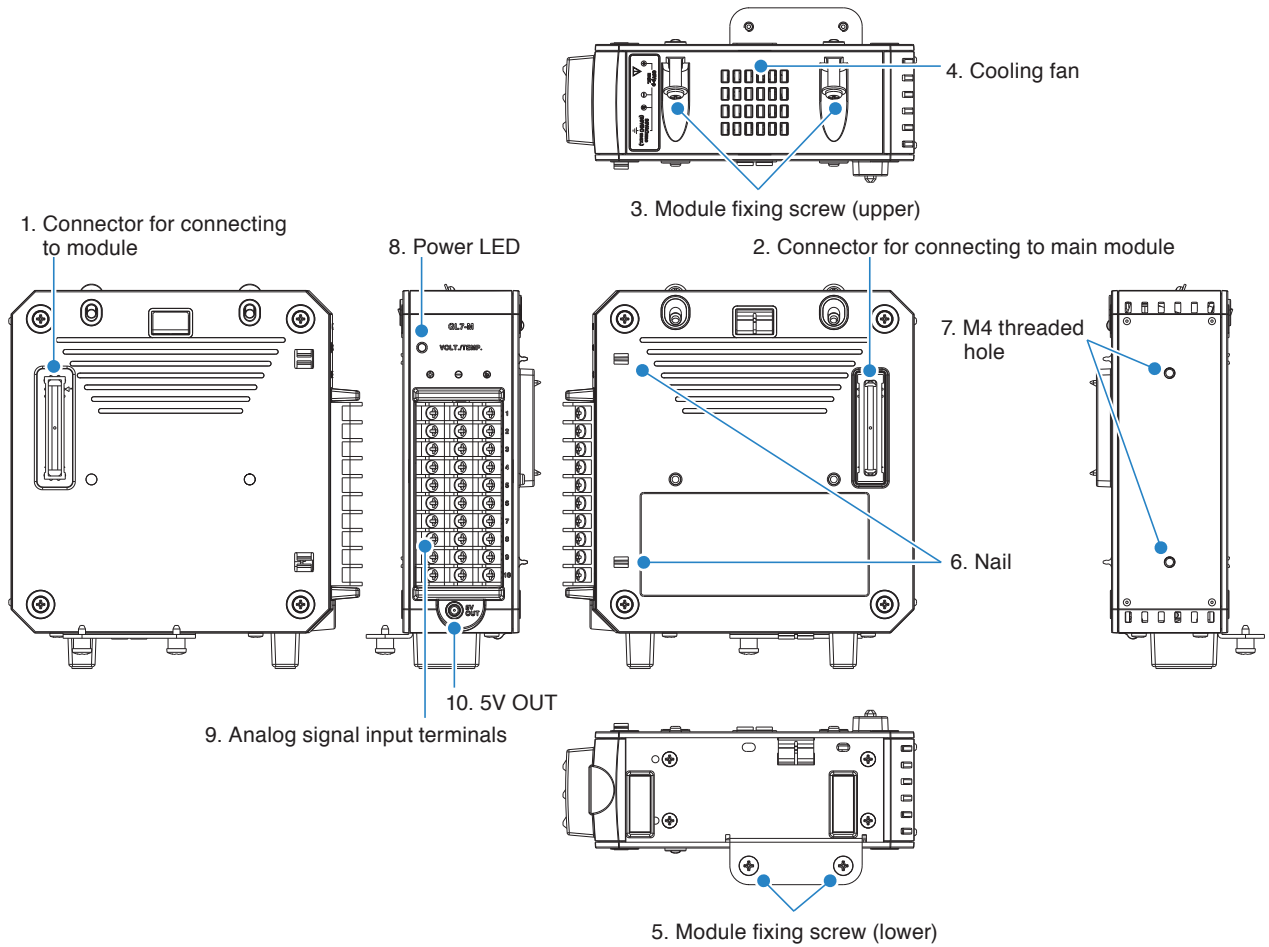

1. Connector for connecting to moduleConnector for connecting to the various modules.
2. Connector for connecting to main moduleConnector for connecting to the GL7000 main module or various modules.
3. Module fixing screw (upper)Fixation screw for the adjoining module.
4. Cooling fanFan to cool internally.
5. Module fixing screw (lower).....Fixation screw for the adjoining module.
6. NailA nail for aiding in positioning when connecting the module.
7. M4 threaded hole.....Use this hole to mount to the panel, etc.
8. Power LEDThe Power LED will light up green when the power has been turned on and the module has been recognized.
9. Analog signal input terminals ...Terminal for inputting analog measurements.
10. 5V OUT.....Power for the temperature sensor (optional: B-530).

Logic/Pulse Module (GL7-L/P): Optional

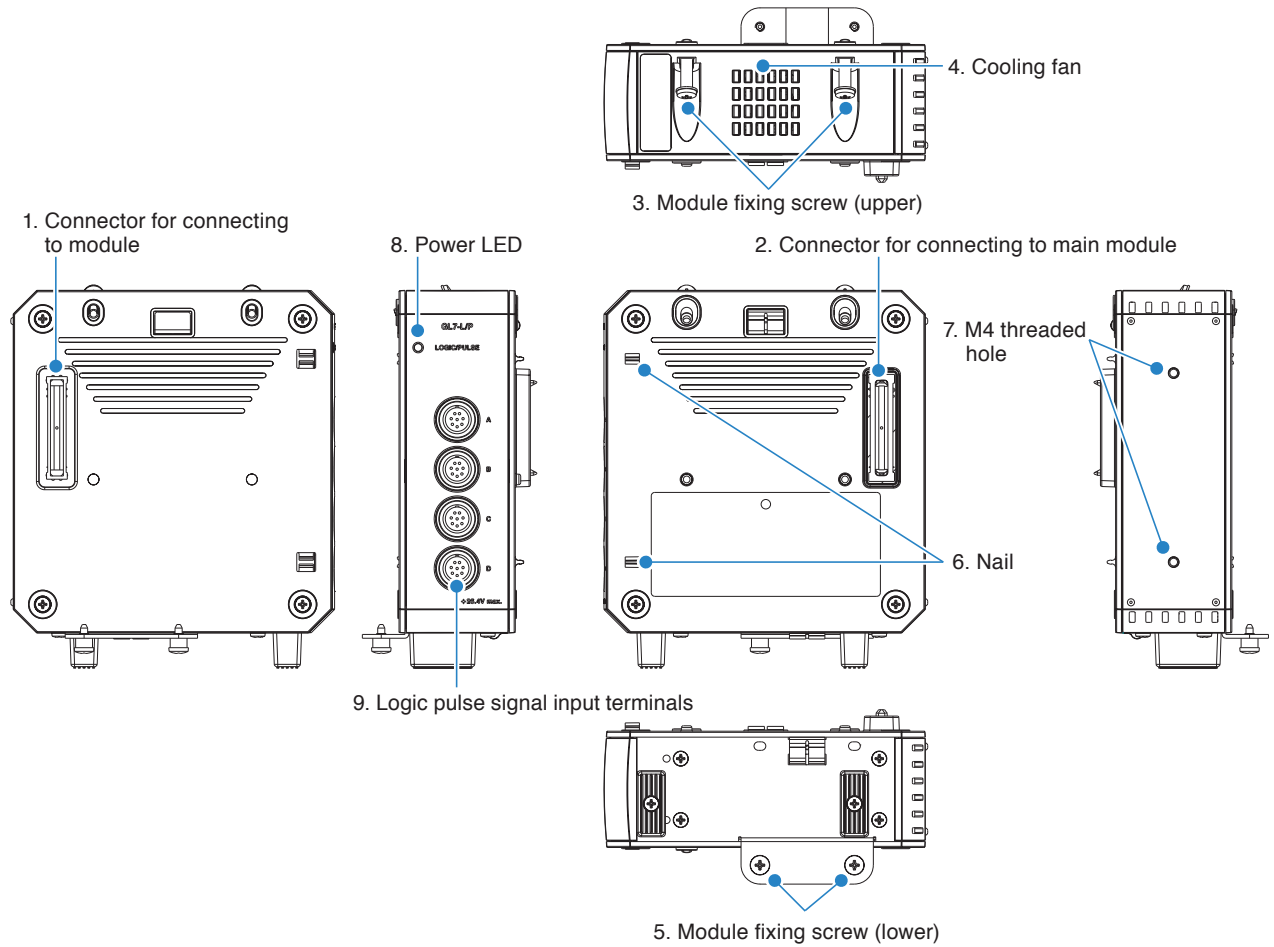

1. Connector for connecting to module
.....Connector for connecting to the various modules.
2. Connector for connecting to main module
.....Connector for connecting to the GL7000 main module or various modules.
3. Module fixing screw (upper)Fixation screw for the adjoining module.
To prevent drop off, please refrain from removing it from the module.
4. Cooling fanFan to cool internally.
5. Module fixing screw (lower).....Fixation screw for the adjoining module.
6. NailA nail for aiding in positioning when connecting the module.
7. M4 threaded hole.....Use this hole to mount to the panel, etc.
8. Power LEDThe Power LED will light up green when the power has been turned on and the module has been recognized.
9. Logic pulse signal input terminals
.....Terminal for inputting analog measurements.
Use the sold separately logic/pulse probe (RIC-10) as input cable.

High voltage Module (GL7-HV): Optional

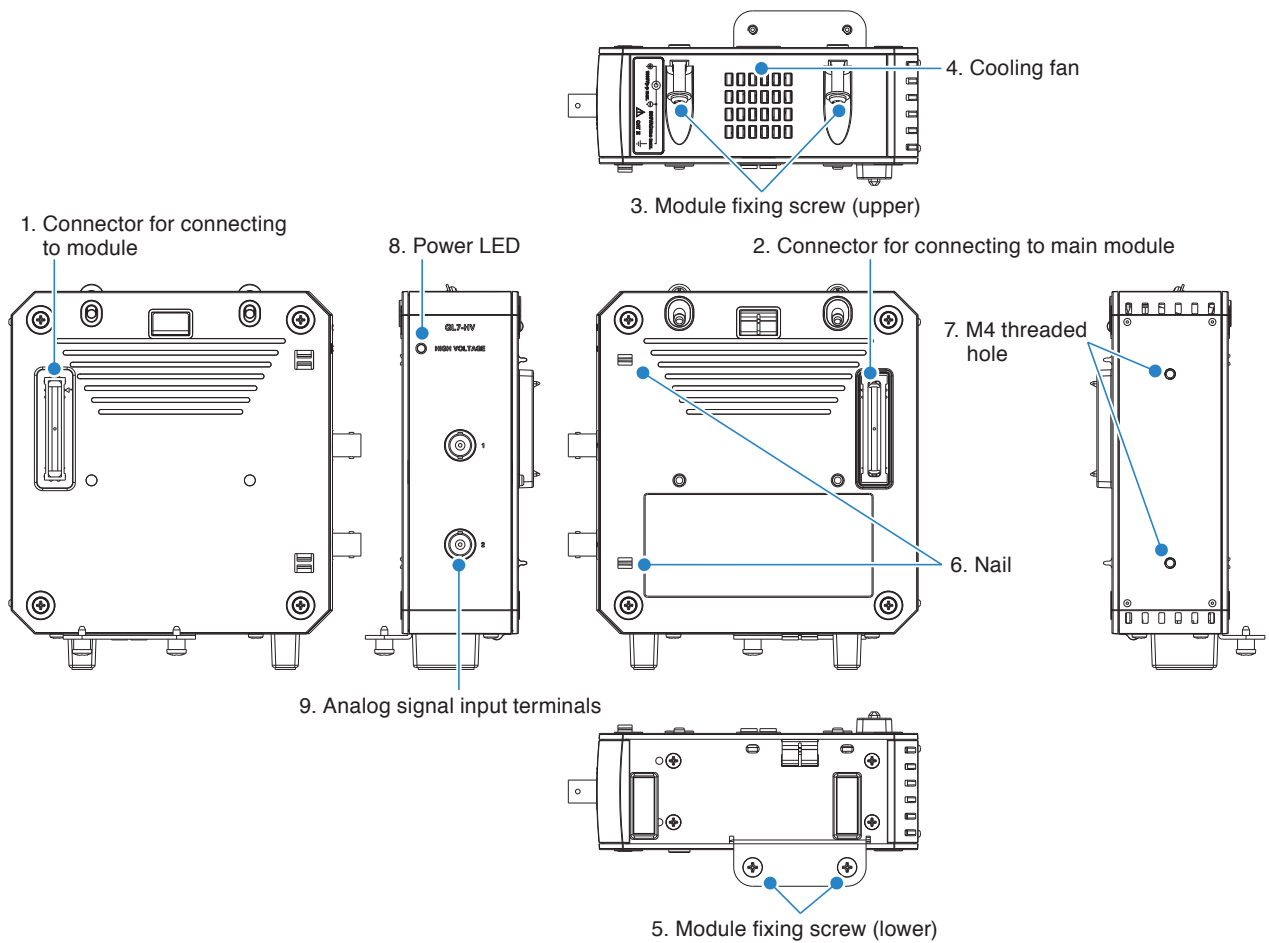

- 1. Connector for connecting to module
.....Connector for connecting to the various modules.
- 2. Connector for connecting to main module
.....Connector for connecting to the GL7000 main module or various modules.
- 3. Module fixing screw (upper)Fixation screw for the adjoining module.
- 4. Cooling fanFan to cool internally.
- 5. Module fixing screw (lower).....Fixation screw for the adjoining module.
- 6. NailA nail for aiding in positioning when connecting the module.
- 7. M4 threaded hole.....Use this hole to mount to the panel, etc.
- 8. Power LEDThe Power LED will light up green when the power has been turned on and the module has been recognized.
- 9. Analog signal input terminals ...Terminal for inputting analog measurements.

DC Strain Module (GL7-DCB): Optional

<DC Strain Module (GL7-DCB) accessories>

- DC Strain Module: 1 unit
- DSUB (male) connector: 4 pcs.

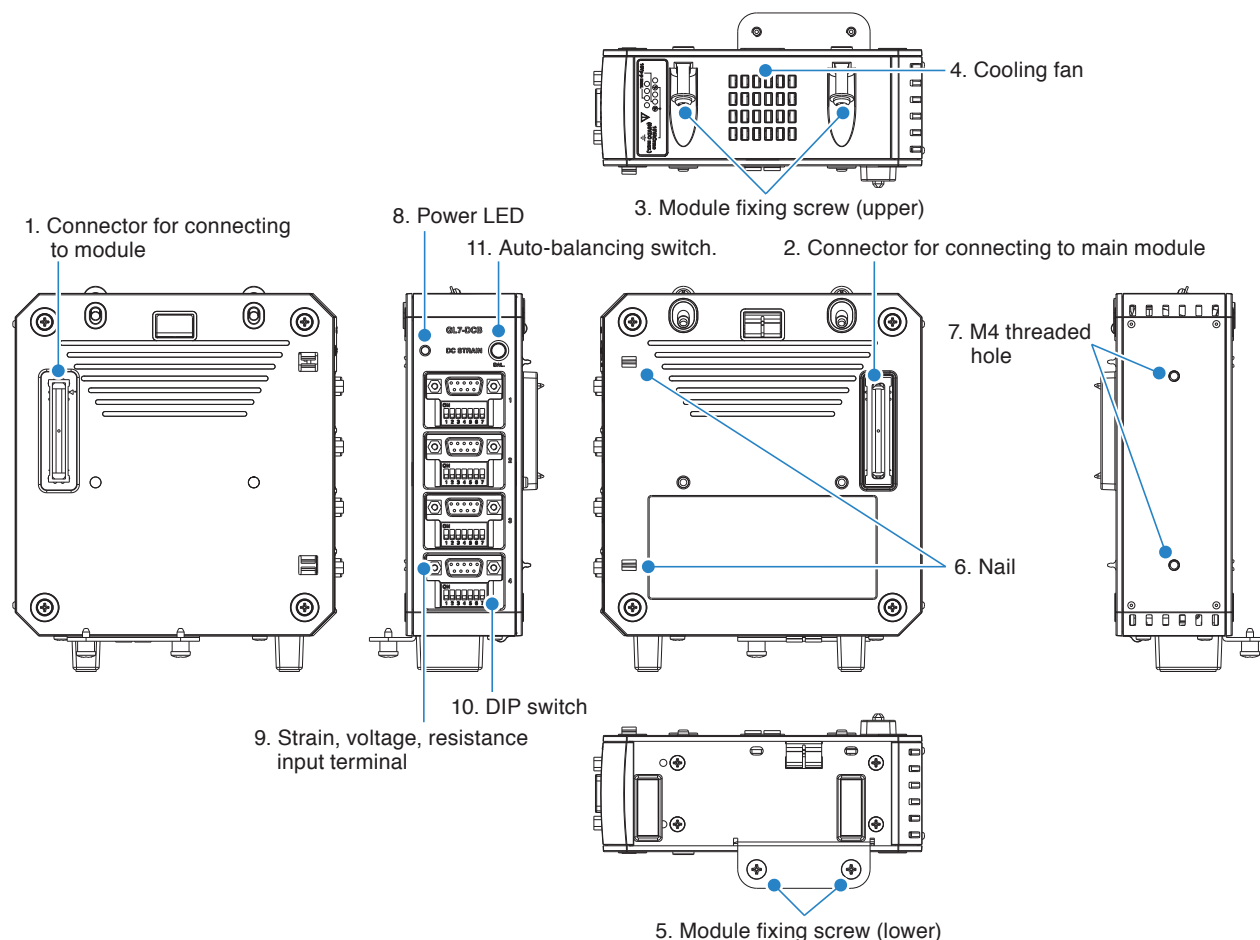

1. Connector for connecting to module
.....Connector for connecting to the various modules.
2. Connector for connecting to main module
.....Connector for connecting to the GL7000 main module or various modules.
3. Module fixing screw (upper)Fixation screw for the adjoining module.
4. Cooling fanFan to cool internally.
5. Module fixing screw (lower).....Fixation screw for the adjoining module.
6. NailA nail for aiding in positioning when connecting the module.
7. M4 threaded hole.....Use this hole to mount to the panel, etc.
8. Power LEDThe Power LED will light up green when the power has been turned on and the module has been recognized.
However, this LED flashes during auto-balancing.
9. Strain, voltage, resistance input terminal
.....Terminal for inputting analog measurements.
10. DIP switch.....This is used to switch to strain, voltage or resistance.
11. Auto-balancing switch.....Set the initial value of the strain to 0 (zero) by pushing the switch.

CAUTION

The number of DC strain modules that can be installed is up to 8 modules. If more than 8 modules are installed, the message is displayed when the power is turned.

Charge Module (GL7-CHA): Optional

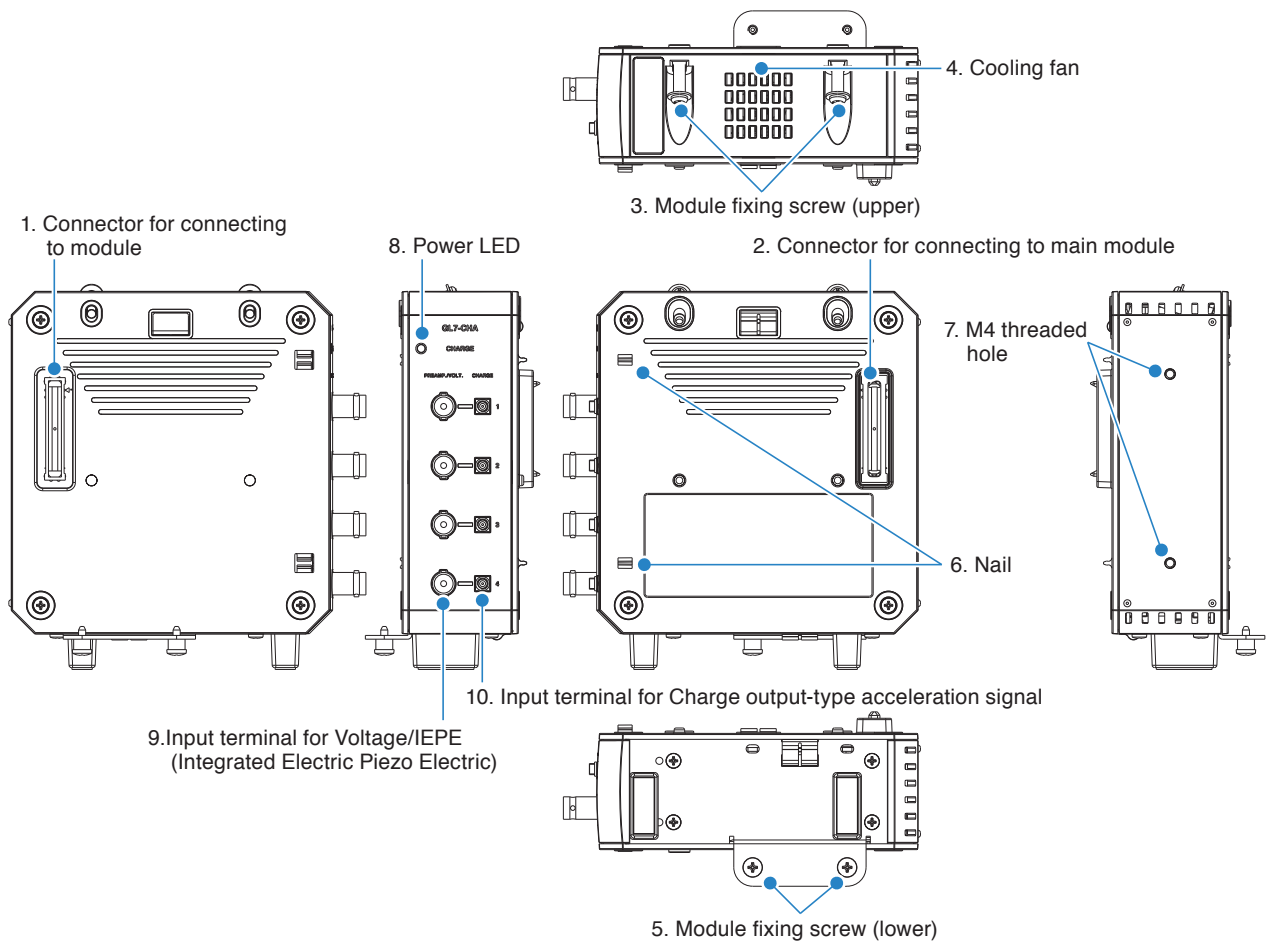

1. Connector for connecting to module
.....Connector for connecting to the various modules.
2. Connector for connecting to main module
.....Connector for connecting to the GL7000 main module or various modules.
3. Module fixing screw (upper)Fixation screw for the adjoining module.
4. Cooling fanFan to cool internally.
5. Module fixing screw (lower).....Fixation screw for the adjoining module.
6. NailA nail for aiding in positioning when connecting the module.
7. M4 threaded hole.....Use this hole to mount to the panel, etc.
8. Power LEDThe Power LED will light up green when the power has been turned on and the module has been recognized.
9. Input terminal for Voltage/IEPE (Integrated Electric Piezo Electric)
.....Terminal for inputting analog measurements.
10. Input terminal for Charge output-type acceleration signal
.....Terminal for inputting analog measurements.

Voltage Output Module (GL7-DCO): Optional

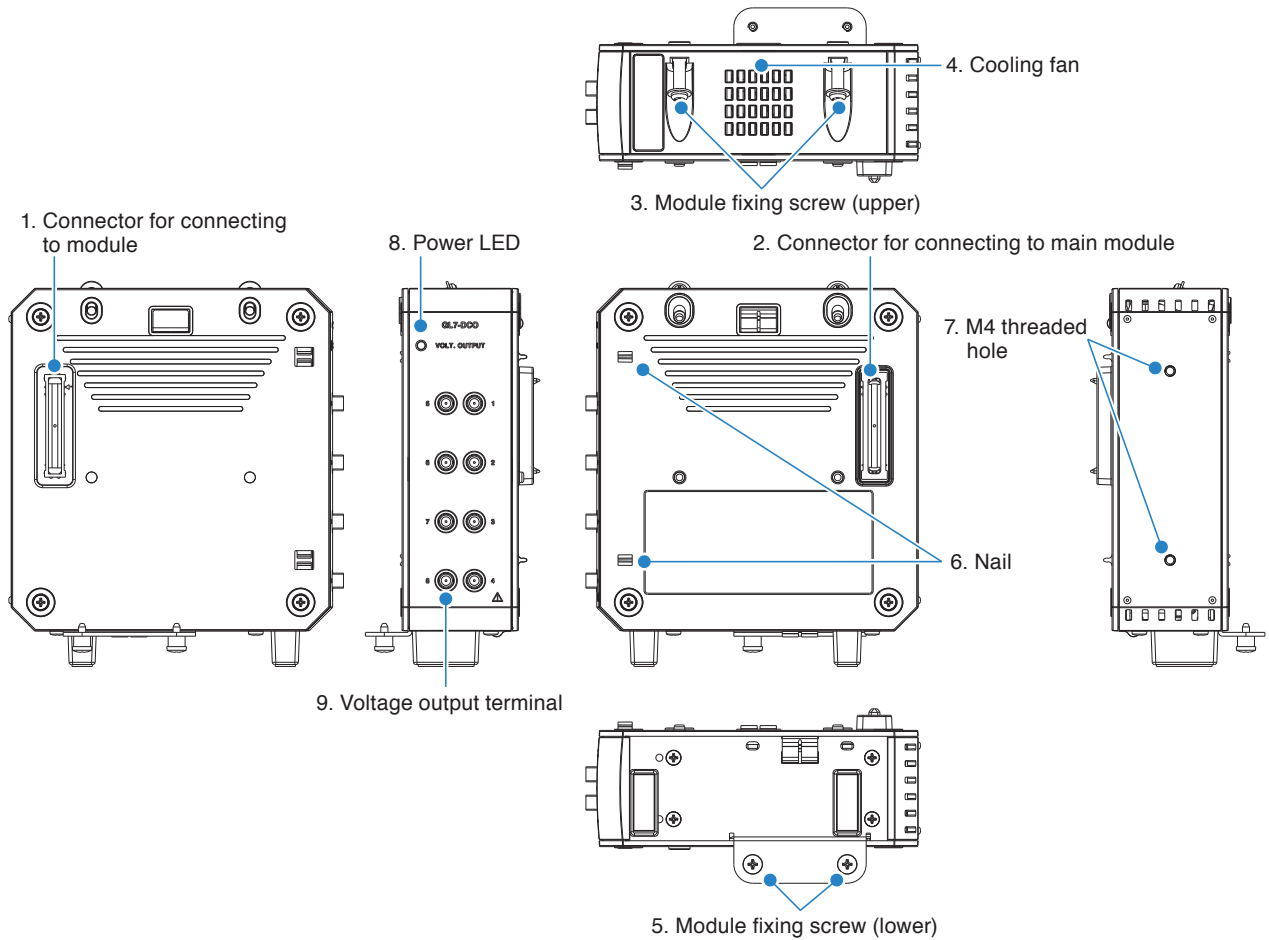

1. Connector for connecting to module
.....Connector for connecting to the various modules.
2. Connector for connecting to main module
.....Connector for connecting to the GL7000 main module or various modules.
3. Module fixing screw (upper)Fixation screw for the adjoining module.
4. Cooling fanFan to cool internally.
5. Module fixing screw (lower).....Fixation screw for the adjoining module.
6. NailA nail for aiding in positioning when connecting the module.
7. M4 threaded hole.....Use this hole to mount to the panel, etc.
8. Power LEDThe Power LED will light up green when the power has been turned on and the module has been recognized.
9. Voltage output terminalTerminal for outputting analog voltage. (All channels common ground)

2.7 Installing and removing the Module

This section describes how to install the module. When removing the module, reverse the installing procedure.

⚠ CAUTION

- When installing or removing modules, please make sure that the power is turned off.
- When removing a module, please don't remove it by holding the body. If holding the input terminal part etc. when removing the module there is a risk of damaging it.
- Please make sure to install the attached Alarm Module on the end (left side when looked at from the front) of the machine. If the Alarm Module is not connected, sufficient performance may not be obtained.
- Adequate precautions against static electricity must be taken when handling the modules.
- After installation, please make sure to tighten all module fixing screws. Using without tightening the module fixing screws can cause damage to the module.
- Please note that the setting conditions are initialized when changing the configuration of the amplifier module for measurement.

Installing the Display Module (GL7-DISP: optional) and GL7000

The Display Module has 3 basic configurations when in use.

- A: When installing the main module: Assembled to the main module configuration.
- B: When using the tilting table: Assembled to the main module using the tilting table (at a 15° tilt angle) configuration.
- C: When using the extension cable: Using a commercially available LAN cable and installing the Display Module away from the main module configuration.

A: This explains how to install when mounting the main module

⚠ CAUTION

When installing or removing modules, please make sure that the power is turned off.

- (1) Remove fixation screws from the main module (2 places on the side)
- * Use the removed screw to secure the Display module.

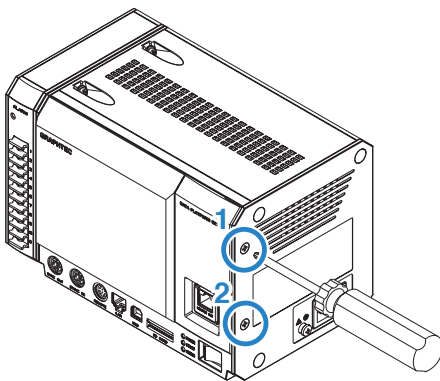

- (2) Pull the nail on the upper-right side of the face cover, and remove the face cover.

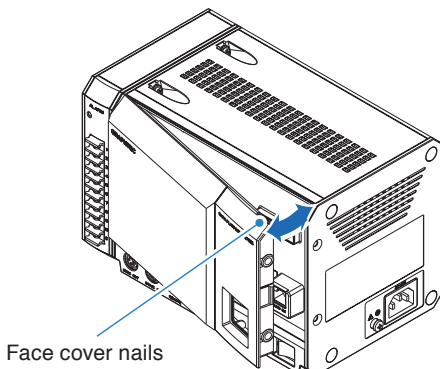

- (3) Join the nails on the back of the Display Module with the inset part of the main module, and push it in.

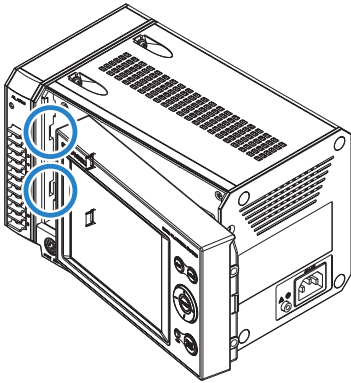

- (4) Join the Display Module with the module connector, and insert into the main module.

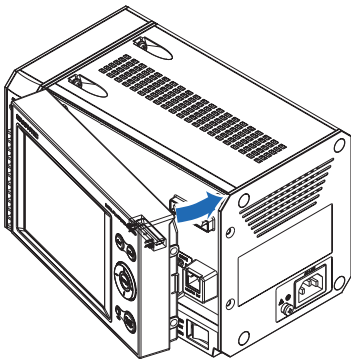

- (5) Attach the fixation screws of the main module (2 places on the side). Using the screw removed when the face cover is removed, secure it.

CHECKPOINT 

During installation, a 4kgf/cm screw tightening torque is recommended.

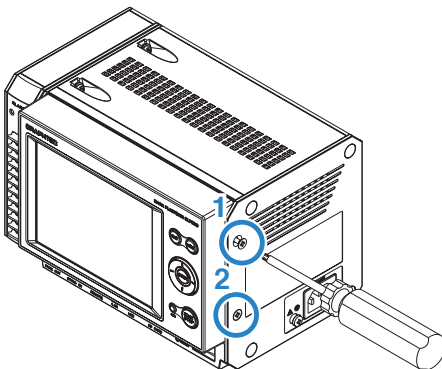

CAUTION 

Since the touch-screen on the main module is calibrated when turning on power, do not touch it at power-up. When turning on power while touching the touch-panel, the touch panel may not start properly.

B: This explains how to attach the tilting table for use.**⚠ CAUTION**

When installing or removing modules, please make sure that the power is turned off.

(After removing the main module face cover)

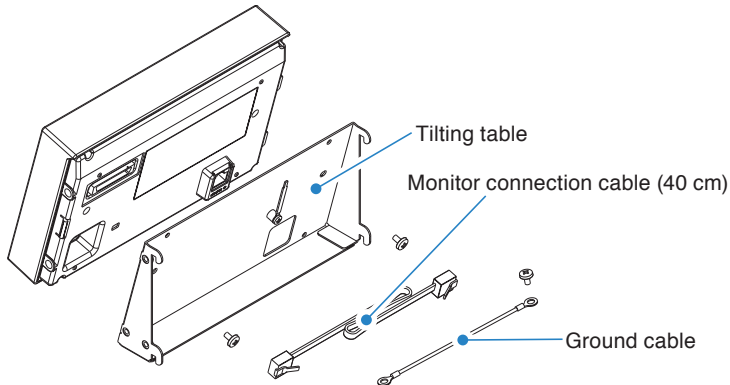

- (1) Install by binding the monitor connection cable with the clamp on the tilting table.

CHECKPOINT

Bind so that there is approx. 25 cm between the monitor connection cable and the connector.

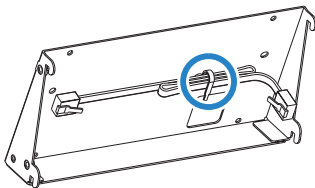

- (2) Attach the Display Module to the tilting table with the attached fixation screws (2 places)

CHECKPOINT

During installation, a 4kgf/cm screw tightening torque is recommended.

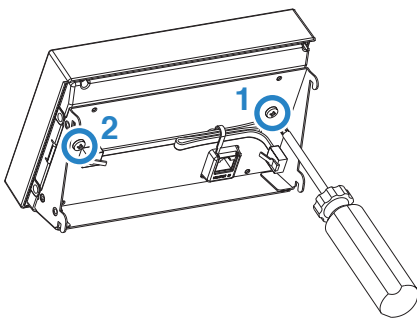

- (3) Connect the connector of the monitor connection cable to the monitor in connector of the Display Module.

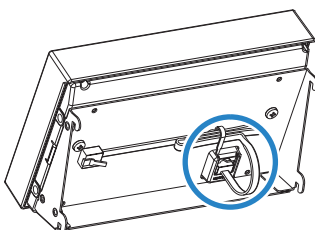

- (4) Connect the monitor connection cable to the monitor out connector of the main module and attach the 4 point nails on the tilting table by fixing them to inset part of the main module (4 places).

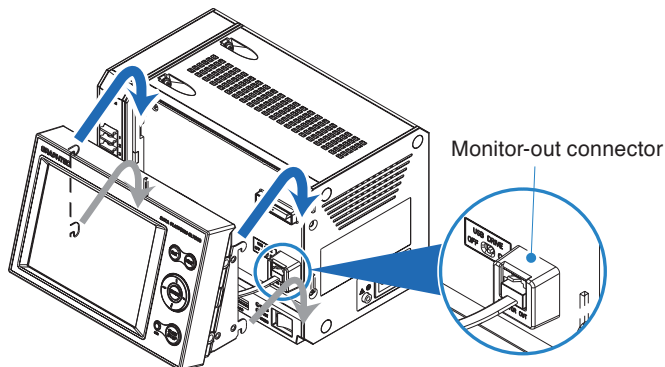

- (5) Attach the fixation screws on the main module (2 places on the side). Using the screw removed when the face cover is removed, secure it.

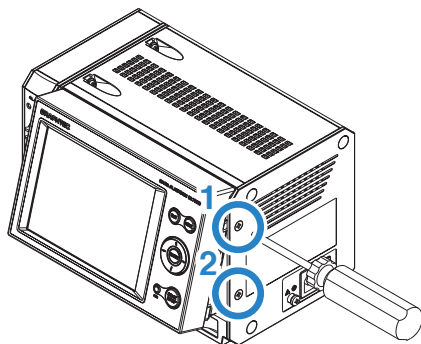

- (6) Attach the ground cable to the main module (GND terminal) with the fixation screws attached to the tilting table.

* If the ground cable supplied with the Display module is not connected, sufficient performance may not be obtained.

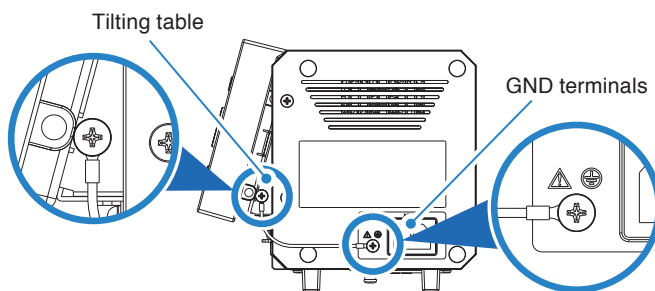

CHECKPOINT

- During installation, a 4kgf/cm screw tightening torque is recommended.
- If the ground cables included with the Display module is not connected, sufficient performance may not be obtained.
- To reduce the impact of noise, always connect the power cable with ground connection. For details, see "2.9 Connecting the Power Cable and Turning on the Power" on page 2-28.

CAUTION

Since the touch-screen on the main is calibrated when turning on power, do not touch it at power-up. When turning on power while touching the touch-panel, the touch panel may not start properly.

C: This explains installation when extending cables.**⚠ CAUTION**

When installing or removing modules, please make sure that the power is turned off.

(After the main module's face cover is mounted)

- (1) Connect the monitor out contact on the main module and the monitor in contact on the Display Module with a commercially available LAN cable.

* Please note the specifications of the LAN cable you use.

[LAN Cable specifications]

- Type: Straight cable
- Category: CAT5 or above
- Cable length: 10 m or less

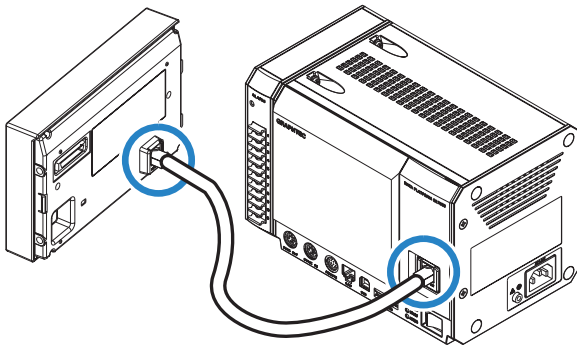
**⚠ CAUTION**

- Please do not connect a LAN cable with the monitor in connector of the Display Module and the LAN connector of the main module.
- Please do not via HUB or a network between monitor in connector of the Display Module and monitor out connector of main module.
- Please use the display module fixed to a board, etc.

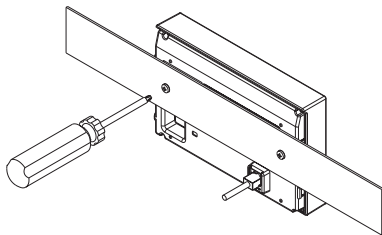
**CHECKPOINT**

To reduce the impact of noise, always connect the power cable with ground connection.
For details, see "2.9 Connecting the Power Cable and Turning on the Power" on page 2-28.

Installing the amplifier module for measurement (optional) and main module

⚠ CAUTION

- When installing or removing modules, please make sure that the power is turned off.
- Please note that the setting conditions are initialized when changing the configuration of the amplifier module for measurement.

(Here, we explain using the Voltage Module as an example)

- (1) Remove the module fixing screws (4 places on the upper and lower part) and slide the Alarm Module parallel to the main module in the direction of the arrow.
 1. Remove the fixing screws from 2 places on the lower part.
 2. Loosen the drop-off prevention screws on 2 places on the upper part.
 3. Remove the Alarm Module.

⚠ CAUTION

When installing or removing modules, please make sure that the power is turned off.

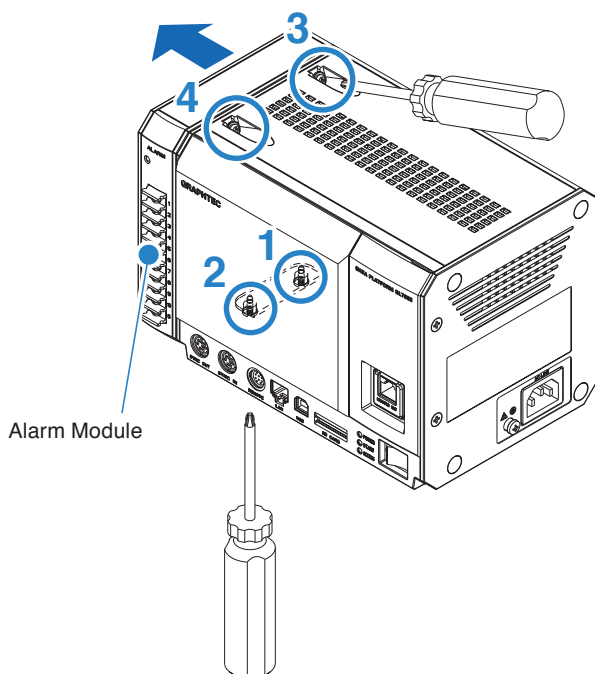

- (2) Remove the Voltage module's fixation screws (2 places on the lower part)

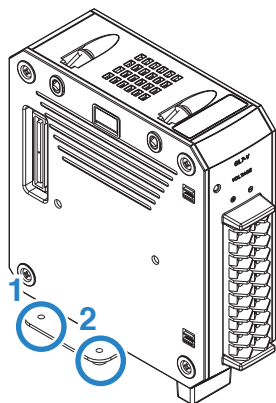

- (3) Connect the connector by sliding it parallel to the main module.

⚠ CAUTION

Slide it in the direction of the arrow. If you pry it at an angle there is a risk of damaging the nail.

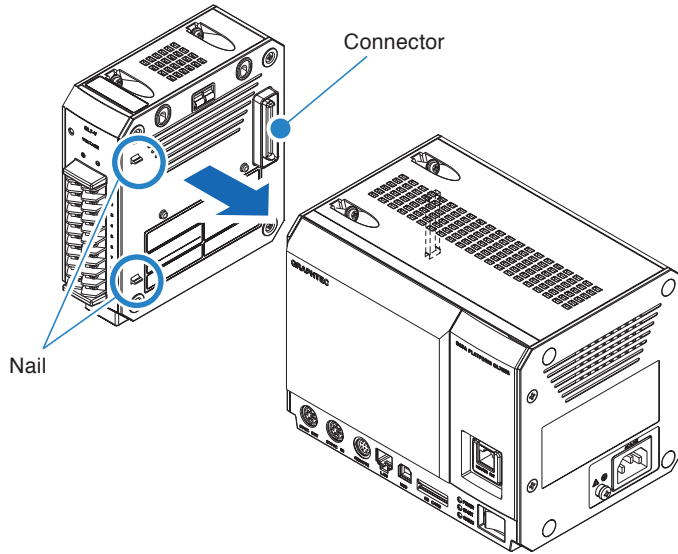

- (4) Fix the voltage module and the main module in place with the screws (4 places on the upper and lower part).

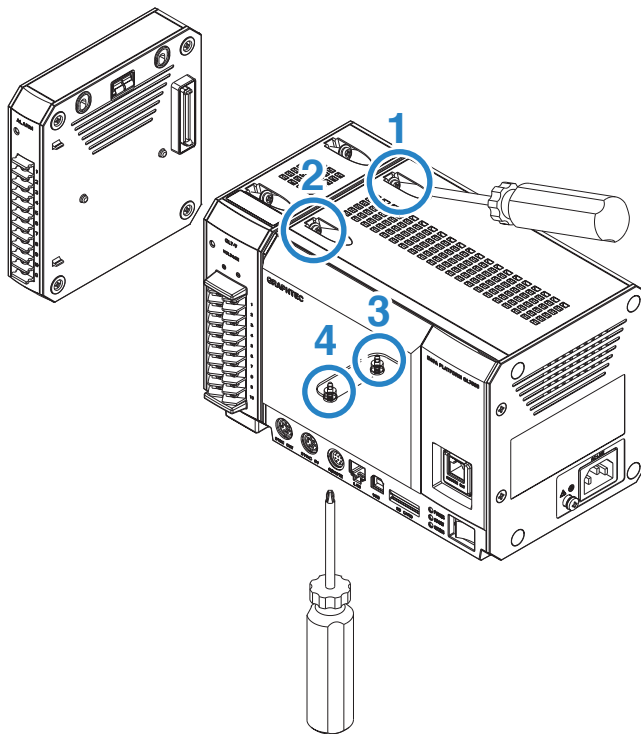

- (5) Connect the connector by sliding the Alarm module parallel to the GL7000 main module to the last part.

⚠ CAUTION

Slide it in the direction of the arrow. If you pry it at an angle there is a risk of damaging the nail.

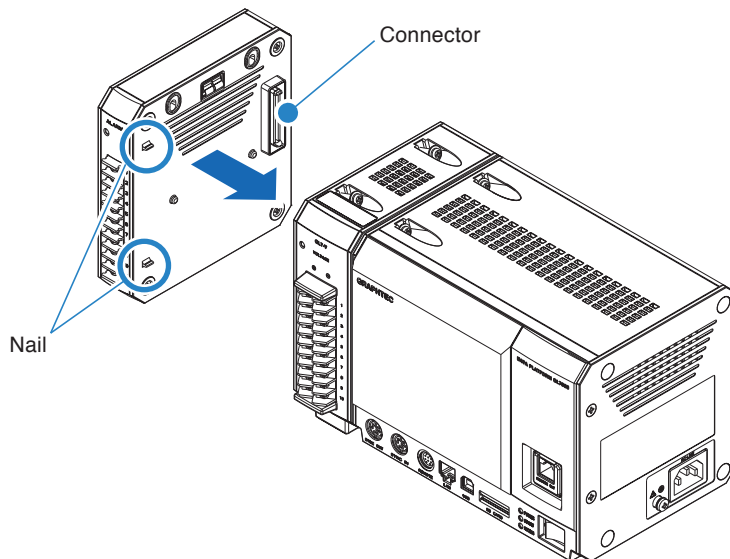

- (6) Secure the Alarm module with the screws (4 locations upper/lower).

CHECKPOINT

During installation, a 4kgf/cm screw tightening torque is recommended.

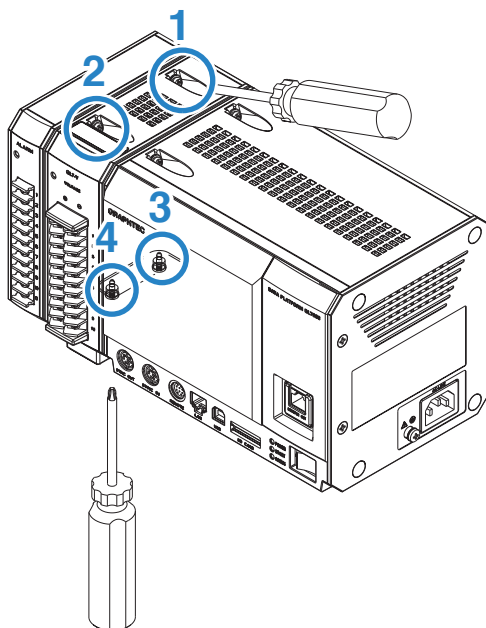

When installing multiple modules

Install 1 module at a time according to the procedures above.
Finally, make sure to tighten with screws before installing the next Module.

Precautions to install SSD Module

The SSD Module is used by installing it on the main module together with other measuring modules. The SSD module is installed in the same way as other Measuring Amplifier modules, but please make sure to connect it to the GL7000.

< Example of installing >

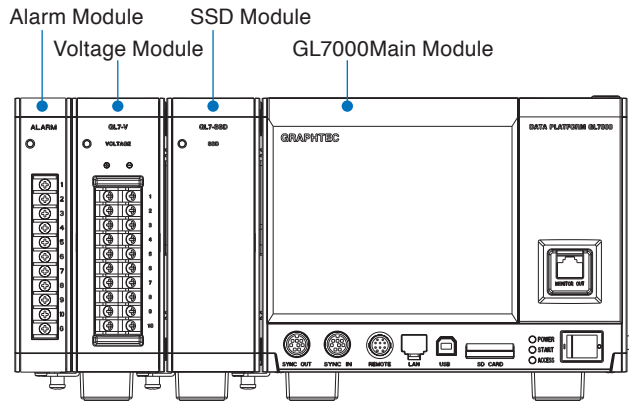

2.8 Installing

Installation location

When installing to the instrumentation panel, please note the following.
 When using on a desk, please refer to "Configuration When in Use" (P1-4).

A well-ventilated location

In order to prevent the temperature from rising inside the machine, please install it in a well-ventilated location. The machine has ventilators and cooling fan exhaust vents. Please do not block these ventilators and exhaust vents.

Please allocate more space than the specified dimensions. (Please refer to "Installation space".)

Installation space

Top view

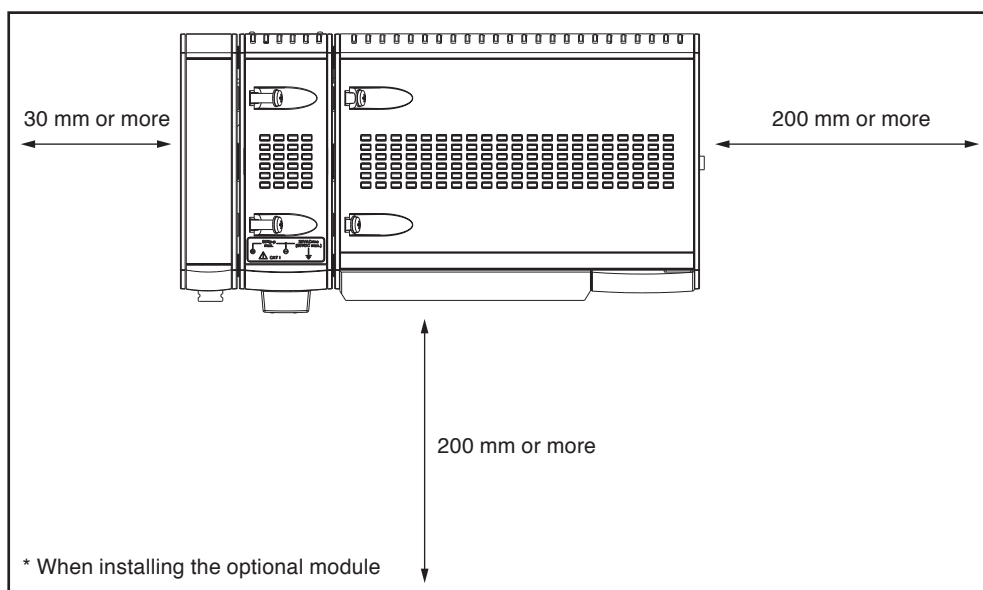

Front view

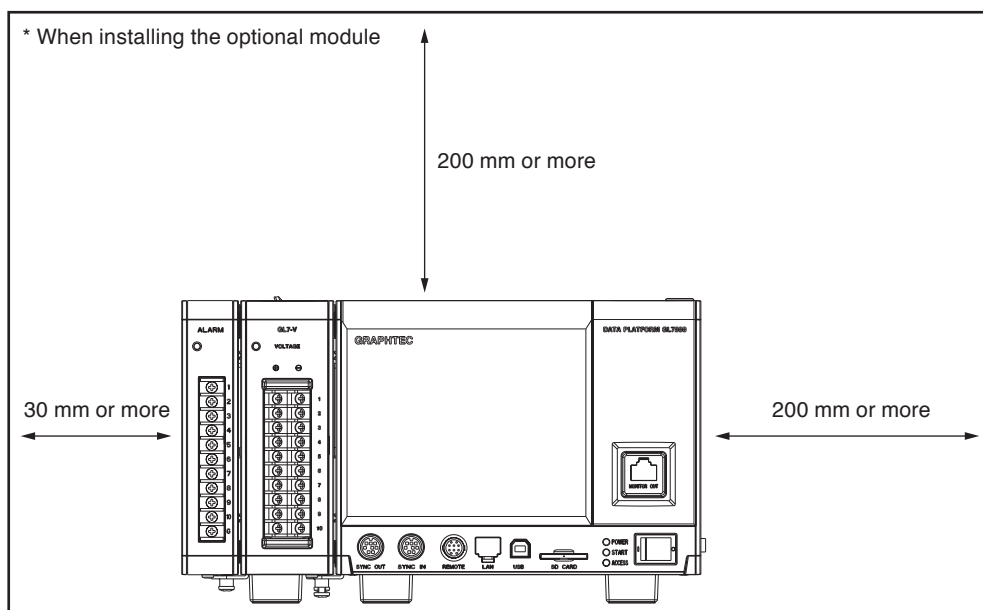

A location with a low amount of mechanical vibrations

Please install in a location with a low amount of mechanical vibrations.

A horizontal location

When installing the machine, please make sure that it's horizontal and doesn't lean to any side.

⚠ CAUTION

Condensation may be caused by moving from a location with a low temperature and humidity to one with high temperature and humidity, or by sudden temperature changes.

Furthermore, during thermocouple input, measurement errors may be yielded. In these cases, use the machine after letting it get accustomed to the surrounding environment for 1 and a half hour or more.

Please do not install in locations such as those listed below.

- Outdoors
- Close to locations with direct sunlight or heaters.
Please choose a place with a low amount of temperature changes and with a normal temperature (23_) to install it in.
- Locations with lots of oily smoke, steam, humidity, dust, and corrosive gas.
Oily smoke, steam, humidity, dust, and corrosive gas have a bad effect on the machine. Please avoid installing the machine in locations where these are abundant.
- Close to electromagnetic field generation sources
Please avoid putting tools that give off magnetism and magnets close to the machine.
If the machine is used close to an electromagnetic field generation source, it may cause measurement errors.

How to install (GL7000 and amplifier module, etc.)

When fixing to the surface of an instrumentation panel, before installing please install the modules and check the screws.

Regarding how to install the Module, please refer to "2.7 Installing and removing the Module".

Furthermore, please note the following when installing.

- Please use M4 screws (length: sheet thickness +6 mm).
- Please make sure to install it on a strong wall.
- For your safety, don't install with too much force.

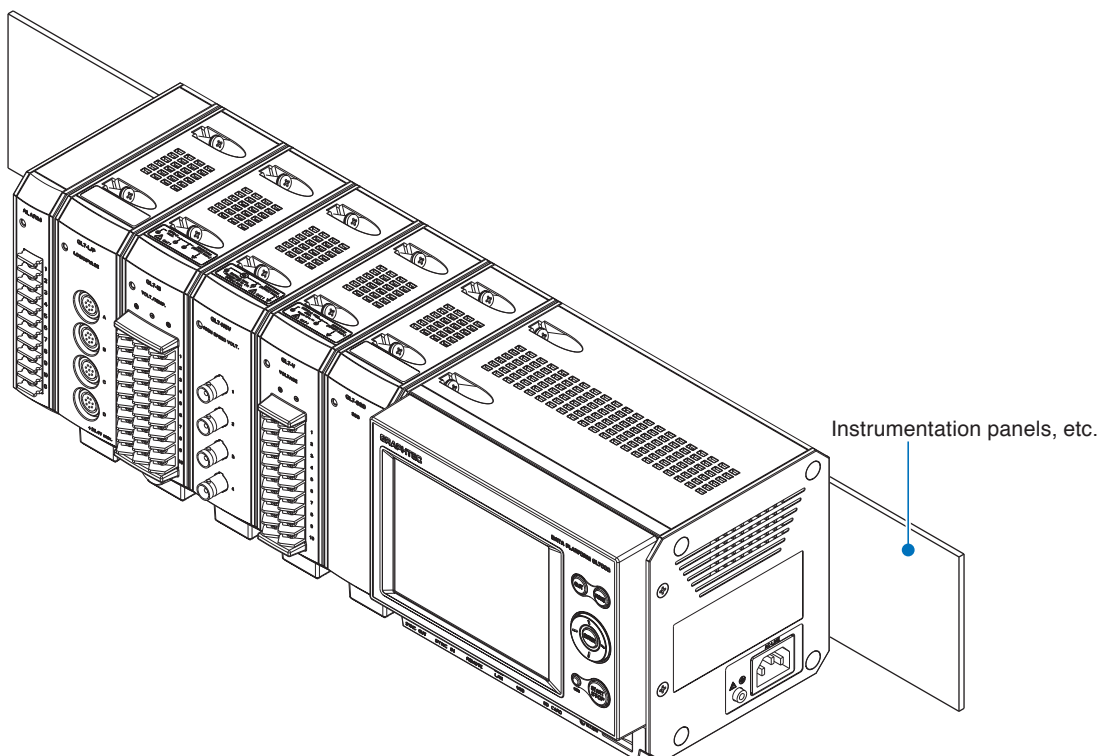

2.9 Connecting the Power Cable and Turning on the Power

This section describes connecting the power cable and turning on the power.

CAUTION

Before turning on the power supply, make sure that all the modules you use are installed. If the module is installed while the power is on, GL7000 may be damaged.

When using AC power

- (1) Please insert the power cable into the AC power connector and the other side into an electrical outlet. If the outlet has no ground terminal, please ground it by using the attached 2-pole/3-pole conversion adapter.

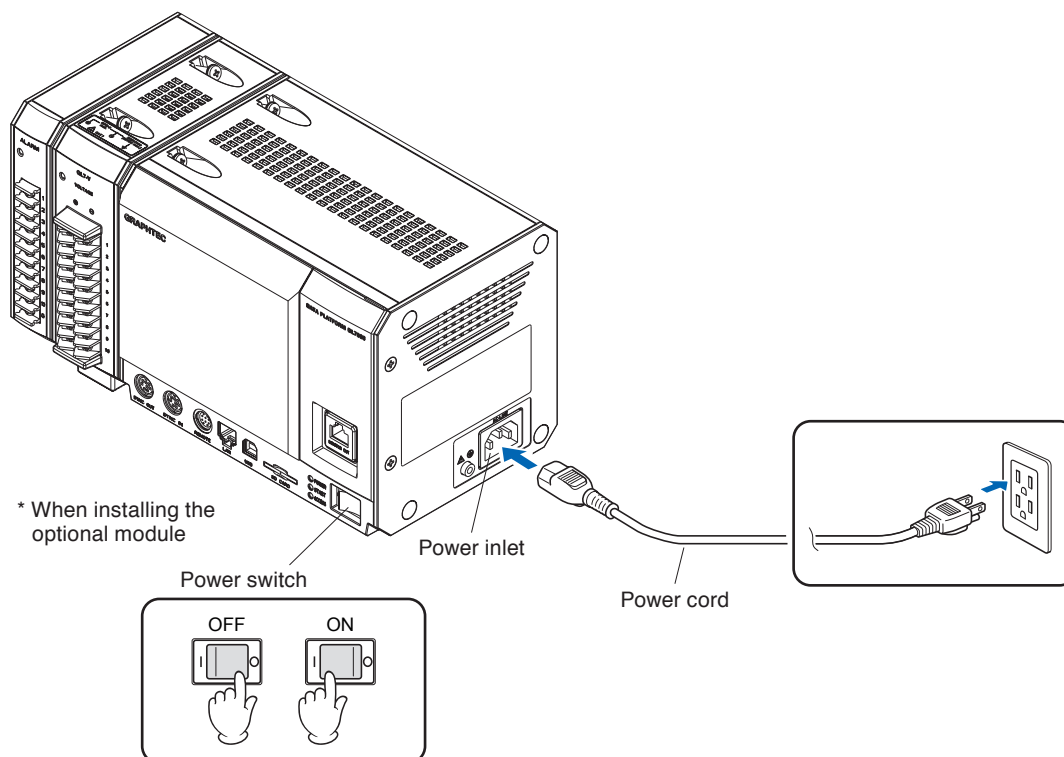

- (2) If the power switch is set to ON, the power is turned on.

CAUTION

- After referring to the safety precautions, please make sure to connect the GND terminal. Also, please connect it even when connecting to other machines using a common GND level.
- The machine is an AC100V/AC200V automatic change system. Please make sure to use a power cord which complies with standards.
- When turning on the power in the state the Amplifier module has not been installed, GL7000 starts up as if one pseudo-Voltage module (GL7-V) is installed.

Connecting to the GND terminal

The GND terminal is used when the power cord cannot be grounded and when the GND level is shared with other equipment.

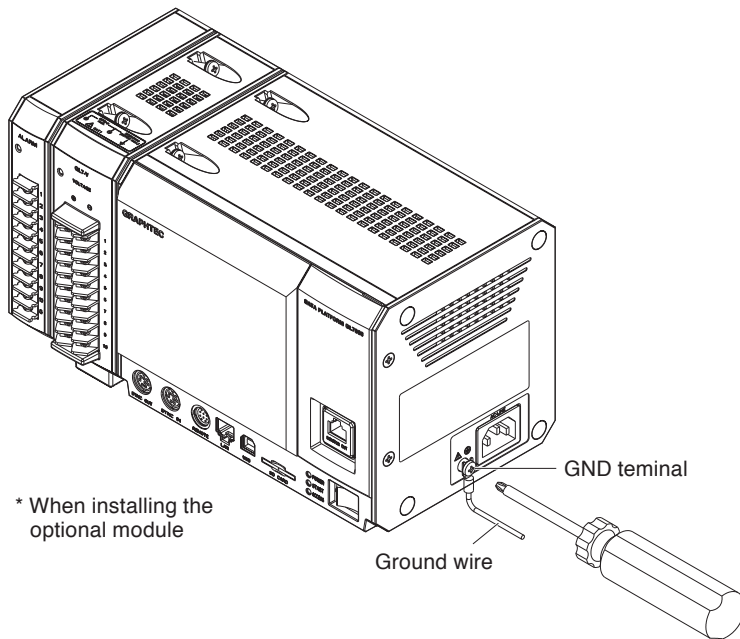

CAUTION

- In order to prevent an electric shock and a fire, please be sure to ground using a GND terminal.
 - For grounding, use a ground wire with a diameter of at least 0.75 mm^2 .
-

2.10 How to Connect to Analog Signal Input Terminal and Precautions

This explains how to connect the analog signal input terminal.

(1) Voltage Module (GL7-V: Optional)

This explains how to connect the input cable.

⚠ WARNING

During wiring, confirm that the signal's supply source is turned OFF to prevent electrical shocks.

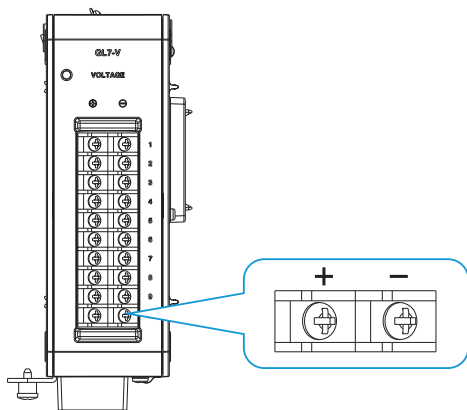

+High-voltage terminal (Terminal for inputting the high-voltage side of the input signal)

-Low voltage terminal (Terminal for inputting the low-voltage side of the input signal)

Direct voltage input

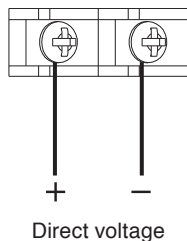

Current input

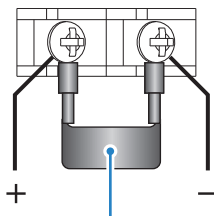

Shunt resistance

Example: In the case of 4-20 mA, apply 250Ω (±0.1%) and measure in the 1-5 V range.

* For shunt resistance, we recommend the use of the optional B-551.

⚠ CAUTION

To avoid break-downs or short-circuiting accidents, please make sure to abide by the items written below.

- Maximum input voltage
 - In case the input voltage exceeds the specifications, the circuit at the input part will break down so even if the input voltage exceeds the specifications only for an instant, please don't input.
 - Please take care that no static electricity is applied on the analog signal input terminal.

<Input terminal +/- terminal interval (A etc. on the figure right)>

Maximum input voltage : 100 mV to 1 V range 60Vp-p
: 2 V to 100 V range 100Vp-p

<Input terminal (-)/Input terminal (-) interval (B etc. on the figure right)>

Maximum input voltage : 60Vp-p
Withstand voltage : 1000Vp-p/1minute

<Input terminal (-)/GND terminal interval C etc. on the figure right)>

Maximum input voltage : 60Vp-p
Withstand voltage : 1000Vp-p/1 minute

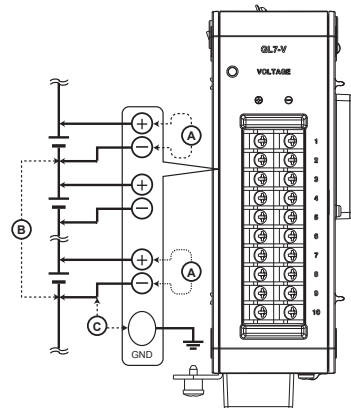

(2) Voltage/Temperature Module (GL7-M: Optional)

This explains how to connect the input cable.

⚠ DANGER

To avoid break-downs or short-circuiting accidents, please make sure to abide by the items written below.

- Do not apply 60Vp-p or higher between the main module (GND terminal) and voltage analog input, and between the analog input channels.

⚠ WARNING

During wiring, confirm that the signal's supply source is turned OFF to prevent electrical shocks.

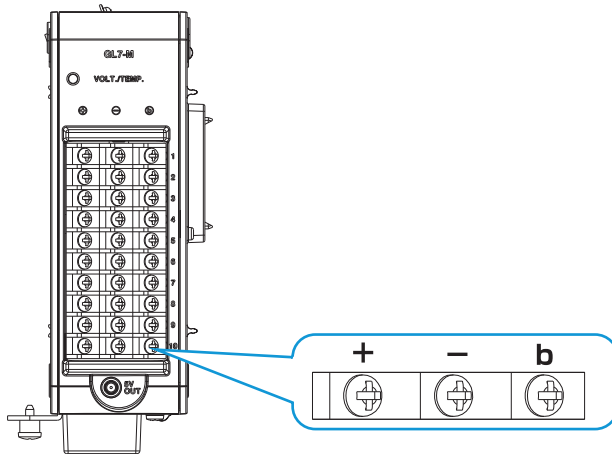

- + High-voltage terminal (Terminal for inputting the high-voltage side of the input signal)
- Low voltage terminal (Terminal for inputting the low-voltage side of the input signal)
- b Terminal for dedicated use when connecting the Resistance Temperature Detector.
The + terminal and - terminal are insulated for each channel, but the b terminal is shorted for every internal channel.

Voltage input

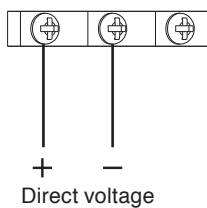

Thermocouple Input

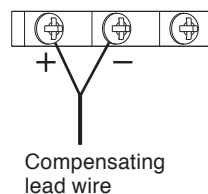

Resistance Temperature Detector input

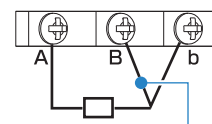

Please use a lead wire resistance of 10Ω or less for 1 line, and make sure to have the same resistance value for all 3 wires.

Current input

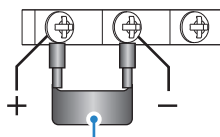

Shunt resistance
Example: In the case of 4-20 mA, apply 250Ω (±0.1%) and measure in the 1-5 V range.

* For shunt resistance, we recommend the use of the optional B-551.

Humidity Sensor Input

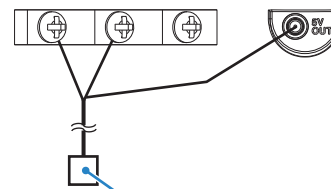

The Humidity Sensor (optional: B-530) 5VOUT is for dedicated use with our B-530.

CAUTION

To avoid break-downs or short-circuiting accidents, please make sure to abide by the items written below.

- Maximum input voltage
 - In case the input voltage exceeds the specifications, the circuit at the input part will break down so even if the input voltage exceeds the specifications only for an instant, please don't input.
 - Please take care that no static electricity is applied on the analog signal input terminal.

<Input terminal +/- terminal interval (A etc. on the figure below)>

Maximum input voltage : 60Vp-p

<Input terminal (-)/Input terminal (-) interval (B etc. on the figure below)>

Maximum input voltage : 60Vp-p

Withstand voltage : 350Vp-p/1minute

<Input terminal/GND terminal interval C etc. on the figure below)>

Maximum input voltage : 60Vp-p

Withstand voltage: : 350Vp-p/1 minute

When measuring the voltage When measuring the temperature

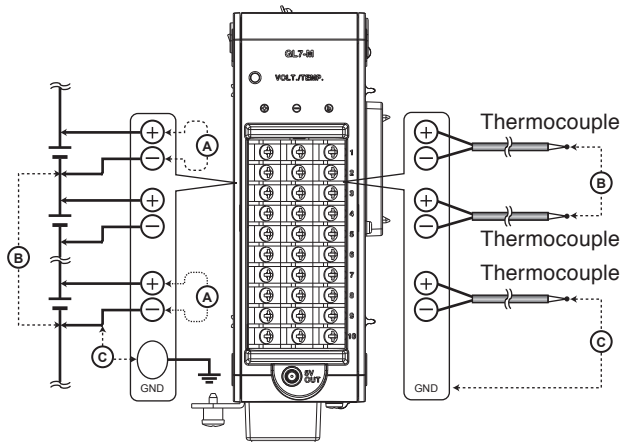

- Input circuit diagram of the analog input (voltage and thermocouple inputs)

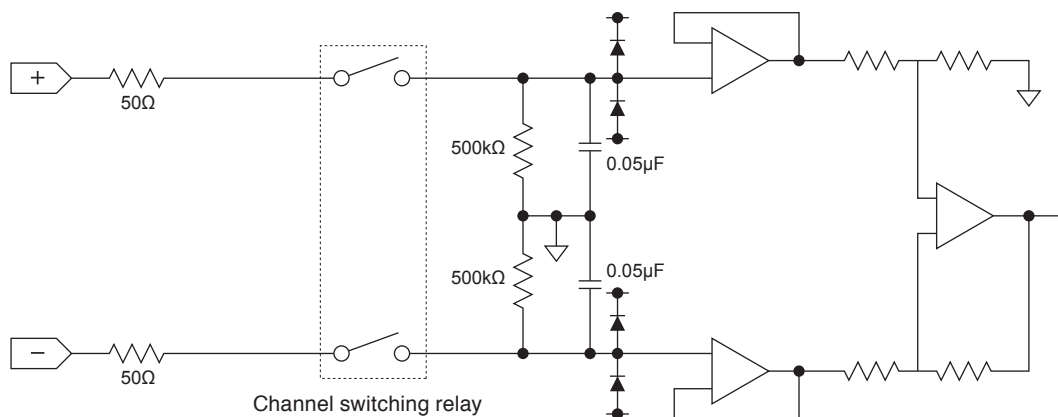

CAUTION

To help improve the efficiency of noise removal, an input condenser is included.
 After measuring voltage, the input will still contain some electricity. Use a separate measuring instrument connected to the + and - terminals beforehand to allow the stored electricity to discharge naturally.
 The Voltage and Temperature modules are used for scanning.
 When there is no input signal, the input may receive interference from other channels.
 You can change input settings to OFF, or short the +/- terminals, to prevent this effect.
 When input is configured correctly and a signal is found, there is no interference from other channels.

(3) High Speed Voltage Module (GL7-HSV: Optional)

This explains how to connect the input cable.

⚠ WARNING

During wiring, confirm that the signal's supply source is turned OFF to prevent electrical shocks.

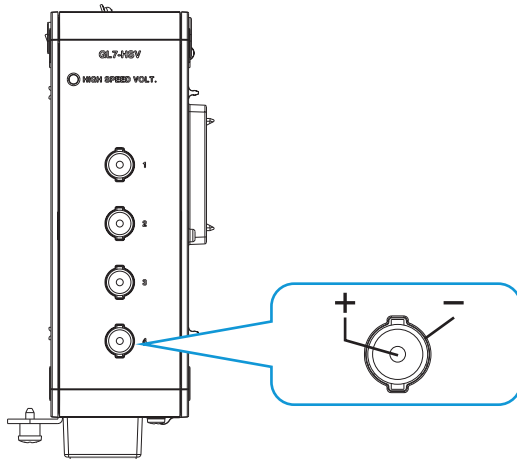

+High-voltage terminal (Terminal for inputting the high-voltage side of the input signal)

-Low voltage terminal (Terminal for inputting the low-voltage side of the input signal)

Voltage input

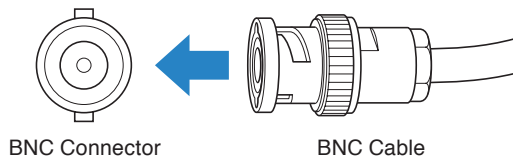

BNC Connector

BNC Cable

⚠ CAUTION

To avoid break-downs or short-circuiting accidents, please make sure to abide by the items written below.

• Maximum input voltage

- In case the input voltage exceeds the specifications, the circuit at the input part will break down so even if the input voltage exceeds the specifications only for an instant, please don't input.
- Please take care that no static electricity is applied on the analog signal input terminal.

<Input terminal +/- terminal interval (A etc. on the figure right)>

Maximum input voltage : 100 mV to 1 V range 60Vp-p
: 2 V to 100 V range 100Vp-p

<Input terminal (-)/Input terminal (-) interval (B etc. on the figure right)>

Maximum input voltage : 60Vp-p
Withstand voltage : 1000Vp-p/1minute

<Input terminal (-)/GND terminal interval C etc. on the figure right)>

Maximum input voltage : 60Vp-p
Withstand voltage : 1000Vp-p/1 minute

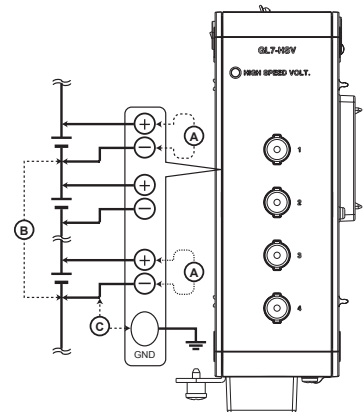

(4) Logic/Pulse Module (GL7-L/P: Optional)

This explains how to connect the input cable.

⚠ WARNING

During wiring, confirm that the signal's supply source is turned OFF to prevent electrical shocks.

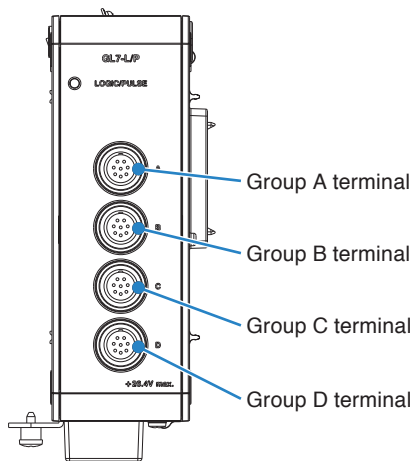

- Group A terminal Logic/Pulse signal group A (CH1 to 4)
- Group B terminal Logic/Pulse signal group B (CH5 to 8)
- Group C terminal Logic/Pulse signal group C (CH9 to 12)
- Group D terminal Logic/Pulse signal group D (CH13 to 16)

- (1) Connect the circular connector side of the RIC-07 (Logic input cable) to the Logic/Pulse signal input terminal.
On the other side, depending on the shape of the measurement, connect a RIC-08 (Alligator clip cable) or a RIC-09 (IC clip cable).

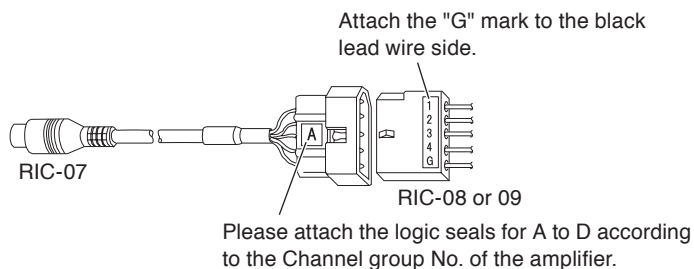

* RIC-07, RIC-08, RIC-09 are optional (sold separately)

- (2) Connection to the measurement point of the RIC-08 (Alligator clip cable) and the RIC-09 (IC clip cable) is shown in the table below.

| Terminal color | Cable color | Channel |
|----------------|-------------|--------------|
| Red | Brown | 1, 5, 9, 13 |
| | Red | 2, 6, 10, 14 |
| | Orange | 3, 7, 11, 15 |
| | Yellow | 4, 8, 12, 16 |
| Black | Black | Common |

To remove the RIC-07 (Logic input cable) and the RIC-08 (Alligator clip cable), or the RIC-09 (IC clip cable) after measurement, insert a screwdriver into the connection and remove it by loosening the indentation.

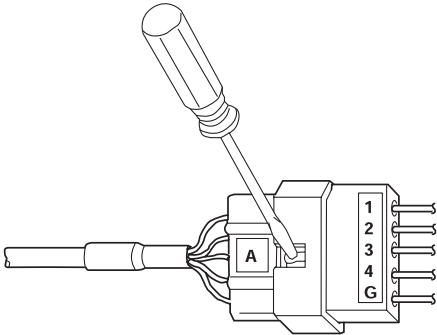

- RIC-10 (Probe set) set contents (optional)
 - RIC-07 (Logic input cable)
 - RIC-08 (Alligator clip cable)
 - RIC-09 (IC clip cable)
 - Logic Seal

CAUTION

To avoid break-downs or short-circuiting accidents, please make sure to abide by the items written below.

- Maximum input voltage
 - In case the input voltage exceeds the specifications, the circuit at the input part will break down so even if the input voltage exceeds the specifications only for an instant, please don't input.
 - Please take care that no static electricity is applied on the logic/pulse signal input terminal.

<Input terminal Each channel / Common terminal interval>

Maximum input voltage : 26.4Vmax

CHECKPOINT

The input of Logic/Pulse module has been pulled up 10K Ω , however, the module may be affected by the external noise when the input is opened.

In such cases, please take the following measures.

- Set the voltage input without having to open the input.
- Set the filter to ON (approx. 50 Hz) in the input settings.

(5) High-voltage Module (GL7-HV: Optional)

This explains how to connect the input cable.

⚠ WARNING

During wiring, confirm that the signal's supply source is turned OFF to prevent electrical shocks. Also, position the GL7000 input cable away from any power lines and ground cables.

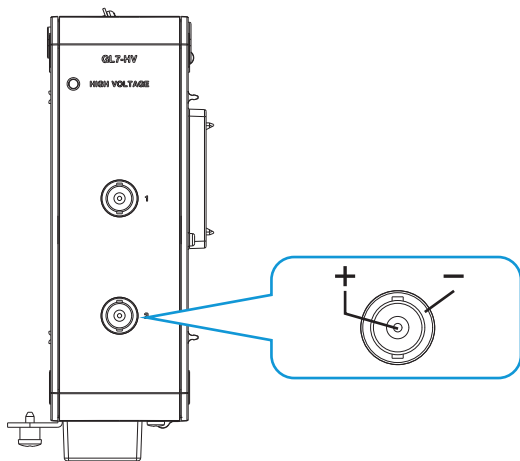

+High-voltage terminal (Terminal for inputting the high-voltage side of the input signal)

-Low voltage terminal (Terminal for inputting the low-voltage side of the input signal)

Voltage input

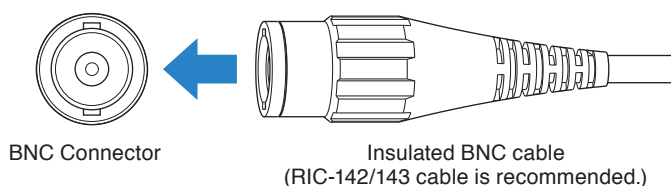

⚠ CAUTION

To avoid break-downs or short-circuiting accidents, please make sure to abide by the items written below.

• Maximum input voltage

- In case the input voltage exceeds the specifications, the circuit at the input part will break down so even if the input voltage exceeds the specifications only for an instant, please don't input.
- Please take care that no static electricity is applied on the analog signal input terminal.

<Input terminal +/- terminal interval (A etc. on the figure right)>

Maximum input voltage : 1000 Vp-p

<Input terminal (-)/Input terminal (-) interval (B etc. on the figure right)>

Maximum input voltage : 300 VACrms

Withstand voltage : 2300 VACrms/1 minute

<Input terminal (-)/GND terminal interval C etc. on the figure right)>

Maximum input voltage : 300 VACrms

Withstand voltage : 2300 VACrms/1 minute

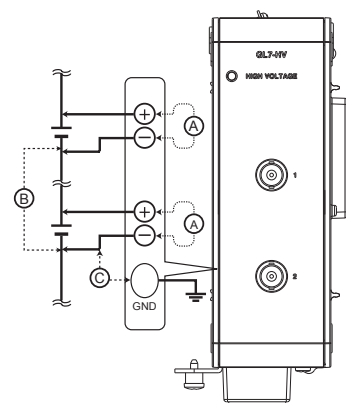

(6) DC Strain Module (GL7-DCB: Optional)

This explains how to connect the input cable.

⚠ DANGER

To avoid break-downs or short-circuiting accidents, please make sure to abide by the items written below.

- Please do not apply more than 60 Vp-p voltage between the voltage analog input part and main module (GND terminal), and between the each analog input channels.

⚠ WARNING

During wiring, confirm that the signal's supply source is turned OFF to prevent electrical shocks. Also, position the GL7000 input cable away from any power lines and ground cables.

⚠ CAUTION

The number of DC strain modules that can be installed is up to 8 modules. If more than 8 modules are installed, the message is displayed when the power is turned.

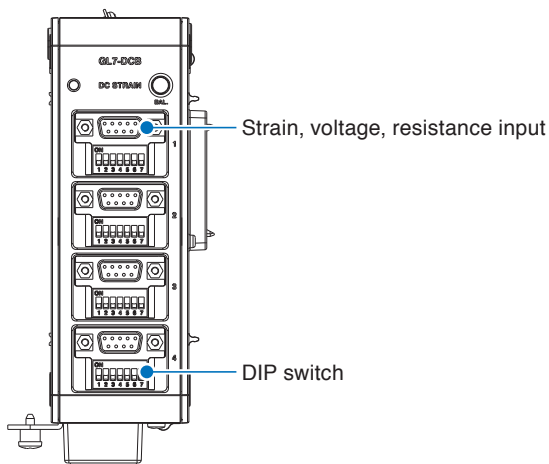

(1) This section provides the descriptions of the terminals and the input terminal arrangement.

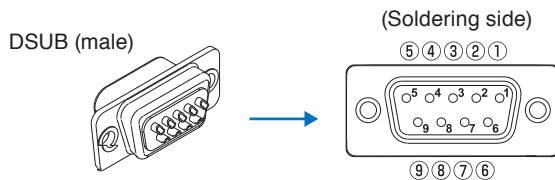

| DSUB Connector No. | Notation | Descriptions | DSUB-NDIS Conversion cable | Conversion cable between DSUB and screw terminal |
|--------------------|----------|------------------------|----------------------------|--|
| ① | E- | Excitation voltage (-) | C | 1 |
| ② | IN- | Input signal (-) | B | 2 |
| ③ | S+ | Sense (+) | - | 3 |
| ④ | T- | TEDS (-) | G | 4 |
| ⑤ | R+ | Shunt resistance | - | 5 |
| ⑥ | S- | Sense (-) | - | 6 |
| ⑦ | IN+ | Input signal (+) | D | 7 |
| ⑧ | E+ | Excitation voltage (+) | A | 8 |
| ⑨ | T+ | TEDS(+) | F | 9 |
| Connector chassis | Shield | Shield | E | FG |

(2) This section explains how to connect the signal input cable with the supplied connector (DSUB).

Strain input

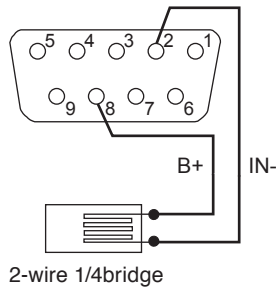

Voltage input

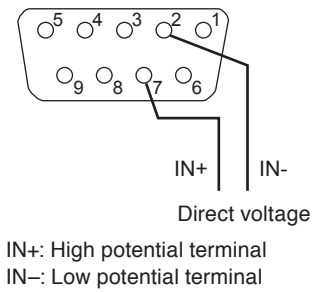

Resistance input

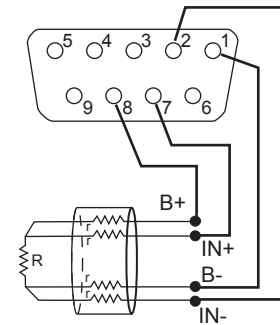

When measuring the resistance, as shown in Figure above, wire using the following 4-wire, or short between (1) and (2), and (7) and (8).

How to assemble the DSUB connector (Standard accessory)

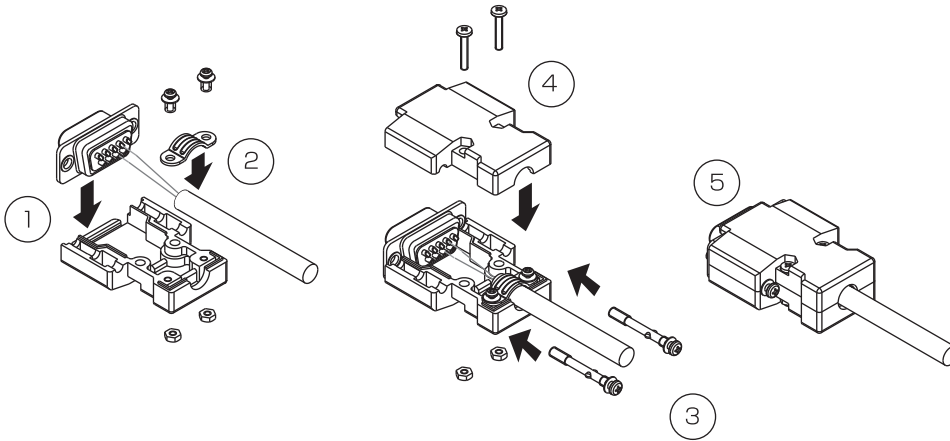

- ① Mount the DSUB connector in the connector cover.
- ② Fix the cable with the cable clamp and 2 screws.
- ③ Set the two DSUB fixing screws to the case.
- ④ Secure with the two screws after putting the connector cover.
- ⑤ Connect the assembled DSUB connector to this module.

⚠ WARNING

To prevent damage to the DSUB connector, do not over-tighten the screws when connecting the connector.
(Recommended tightening torque: 4 kgf·m or less)

(3) This section explains how to connect the conversion cable and the strain sensor.

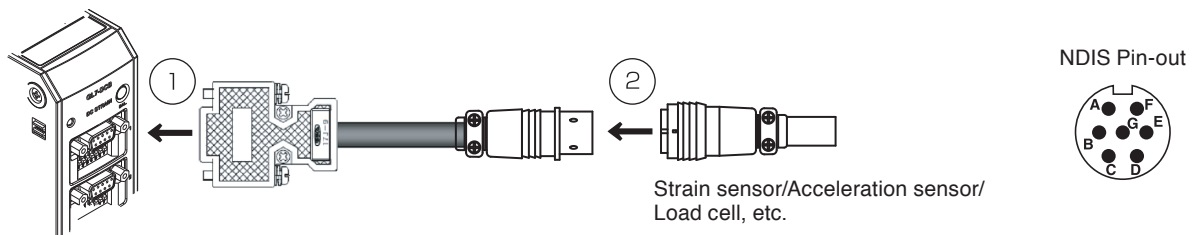

- ① Connect the conversion cable to the DC strain module.
- ② Connect the strain sensor to the conversion cable.

* Please use the NDIS connector manufactured by Tajimi, which conforms to PRC03-12A10-7M10.5.

(4) Wiring and connecting the DSUB-Screw terminals conversion connector.

The following examples show the connection of the DSUB-Screw terminals conversion connector with quarter bridge 2 wires.

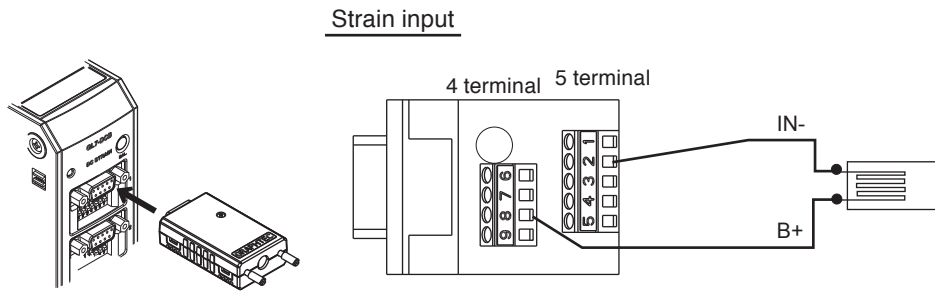

How to assemble the DSUB-Screw terminals conversion connector (Optional B-561)

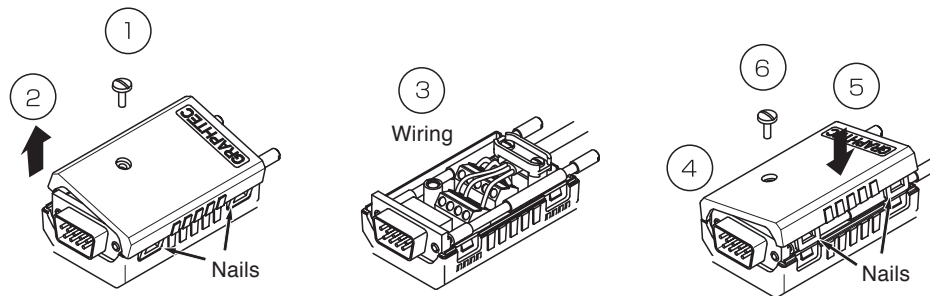

- ① Remove the screw to open the connector cover.
- ② Lift it away from the side of the cover without the nails
- ③ Wire between the internal terminals.
- ④ Fit the connector cover to the side of the cover without the nails.
- ⑤ Push the cover until the side with the nails is locked
- ⑥ Mount the screw removed in step ①. It is completed.

(5) Connecting the TEDS (Transducer Electronic Data Sheet) sensor No. 4 to 9 DSUB terminals are used to connect the TEDS only.

Use to connect the sensor (Standard: IEEE1451.4 Class 2) with TEDS function.

⚠ CAUTION

If the TEDS function is not equipped or the standard is not compatible, the function is not available when connected.

⚠ CAUTION

To avoid break-downs or short-circuiting accidents, please make sure to abide by the items written below.

- Maximum input voltage
 - In case the input voltage exceeds the specifications, the circuit at the input part will break down. Please don't input it.
 - Please take care that no static electricity is applied on the analog signal input terminal.

<Input terminal (+)/ Input terminal (-) interval (A etc. on the figure below)>
Maximum input voltage : DC10Vp-p

<Input terminal (-)/Input terminal (-) interval (B etc. on the figure below)>
Maximum input voltage: 10Vp-p

<Input terminal (-)/GND terminal interval (C etc. on the figure below)>
Maximum input voltage: 60Vp-p
Withstand voltage: 1000Vp-p/1minute

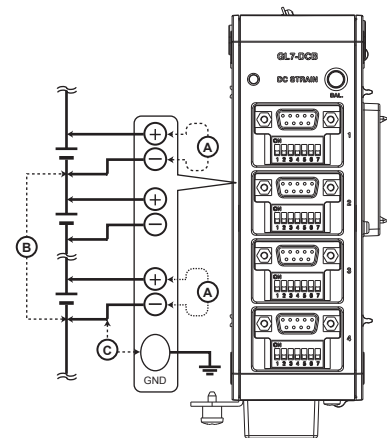

- (6) Setting the DIP switch.
 Depending on the input method, set the switch (See Table below).
 The settings of DIP switch are shown in the Table below. For the numbers in the Table, 0 (zero) is OFF and 1 is ON.

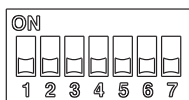

| Input method | | Strain gauge 120Ω | | | | | | | Strain gauge 350Ω | | | | | | |
|--------------------------------|--------------------|-------------------|---|---|---|---|---|---|--|---|---|---|---|---|---|
| | | 1 | 2 | 3 | 4 | 5 | 6 | 7 | 1 | 2 | 3 | 4 | 5 | 6 | 7 |
| Strain input | 2-wire 1/4bridge | 1 | 1 | 1 | 1 | 1 | 1 | 1 | 1 | 1 | 1 | 1 | 1 | 0 | 0 |
| | 3-wire 1/4bridge | 1 | 1 | 0 | 0 | 1 | 1 | 1 | 1 | 1 | 0 | 0 | 1 | 0 | 0 |
| | 4-wire 1/4bridge | 1 | 1 | 0 | 0 | 1 | 1 | 1 | 1 | 1 | 0 | 0 | 1 | 0 | 0 |
| | 3-wire 1/2bridge | 0 | 1 | 0 | 1 | 1 | 1 | 1 | 0 | 1 | 0 | 1 | 1 | 0 | 0 |
| | 4-wire 1/2bridge | 0 | 1 | 0 | 1 | 0 | 1 | 1 | 0 | 1 | 0 | 1 | 0 | 0 | 0 |
| | 5-wire 1/2bridge | 0 | 1 | 1 | 1 | 0 | 1 | 1 | 0 | 1 | 1 | 1 | 0 | 0 | 0 |
| | 4-wire full bridge | 0 | 0 | 0 | 1 | 1 | 1 | 1 | Set the DIP switch as shown in the left table * Voltage and resistance inputs do not affect the strain gauge. | | | | | | |
| 6-wire full bridge | 0 | 0 | 1 | 1 | 0 | 1 | 1 | | | | | | | | |
| Strain sensor input | 4-wire | 0 | 0 | 0 | 1 | 1 | 1 | 1 | | | | | | | |
| | 6-wire | 0 | 0 | 1 | 1 | 0 | 1 | 1 | | | | | | | |
| Voltage input/Resistance input | | 0 | 0 | 0 | 1 | 1 | 1 | 1 | | | | | | | |

CHECKPOINT

The settings of DIP switch are displayed on the menu in the main module. The DIP switch should be set depending on the input method.

• When the strain gauge is used

When the strain is input, set the DIP switch to "bridge circuit".
 Always set depending on the strain gauge resistor.

* See the descriptions of the strain gauge and bridge circuit configuration to set the DIP switch.

• When the strain sensor is used

When the strain sensor is used, the settings are different in 4 wires and 6 wires.

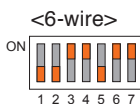
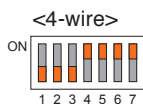

• When the Voltage/Resistance input is used

In this case, set the DIP switch as shown in the figure below regardless of the strain input.

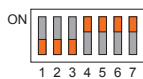

Descriptions of the strain gauge and bridge circuit configuration

The internal bridge circuit of the strain gauge wiring is configured with DIP switch, as shown in the figures below.

⚠ WARNING

When the bridge voltage is used in more than 5 V, the more than 350Ω gauge resistance should be used.
If using 120Ω gauge resistor, the module may be damaged.

| | | Wiring strain gauge | Bridge circuit | Bridge resistor | |
|-------------|--------|---------------------|----------------|-----------------|------|
| | | | | 120Ω | 350Ω |
| 1/4 bridge | 2-wire | | | | |
| | 3-wire | | | | |
| | 4-wire | | | | |
| 1/2 bridge | 3-wire | | | | |
| | 4-wire | | | | |
| | 5-wire | | | | |
| Full bridge | 4-wire | | | | |
| | 6-wire | | | | |

(7) Charge Module (GL7-CHA): Optional

This explains how to connect the input cable.

⚠ WARNING

During wiring, confirm that the signal's supply source is turned OFF to prevent electrical shocks. Also, position the GL7000 input cable away from any power lines and ground cables.

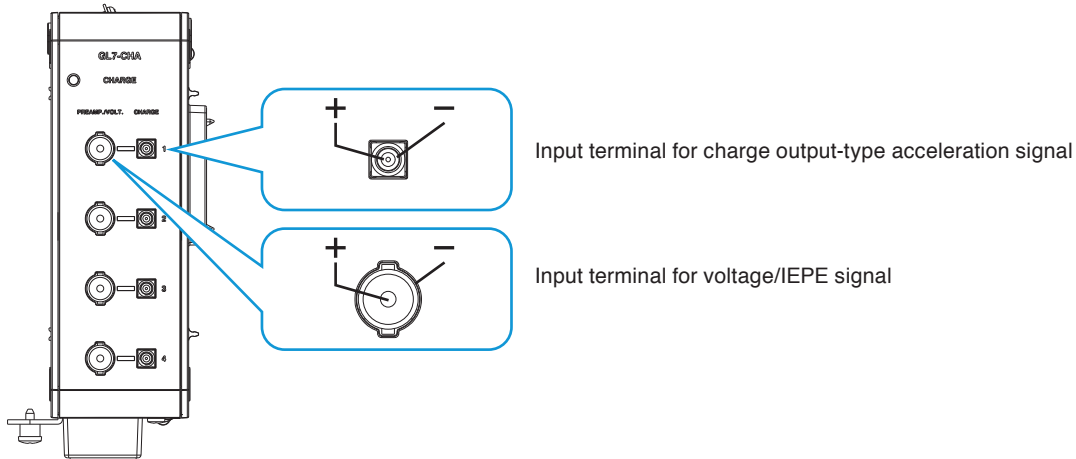

+ High-voltage terminal (Terminal for inputting the high-voltage side of the input signal)

- Low voltage terminal (Terminal for inputting the low-voltage side of the input signal)

⚠ WARNING

Do not connect the two connectors to the same channel. Since this may cause a malfunction, only one connector should be connected to the channel.

Voltage/IEPE signal connection

When connecting the voltage/IEPE, connect to the BNC connector.

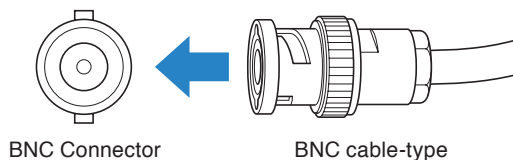

The available acceleration sensor specification is 0.01 mV/(m/s) to 999.9 mV/(m/s).

⚠ WARNING

When the voltage signal is set, change the input setting to DC, AC, DC-RMS, AC-RMS. If Built-in amplifier is set, the power voltage for driving the sensor from the BNC connector is applied. This power voltage may damage the modules and the object to be measured.

Charge-type acceleration signal connection

For the charge-type acceleration sensor connection, connect to the miniature connector.

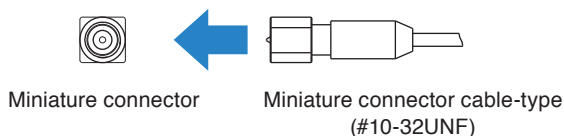

The available acceleration sensor specification is 0.01 pC/(m/s) to 999.9 pC/(m/s).

⚠ CAUTION

To avoid break-downs or short-circuiting accidents, please make sure to abide by the items written below.

- Max. input voltage and charge
 - When the voltage or charge exceeding the specification is input, the input circuit is broken. Do not input the voltage exceeding the specifications even for a moment.
 - Please take care that no static electricity is applied on the analog signal input terminal.

<Input terminal (+)/Input terminal (-) interval(A etc. on the figure below)>

Maximum input voltage : 25Vp-p

Max. input charge : 50000pC

<Input terminal (-)/Input terminal (-) interval(B etc. on the figure below)>

Maximum input voltage : 25Vp-p

Withstand voltage : 300Vp-p/1minute

<Input terminal (-)/GND terminal interval(C etc. on the figure below)>

Maximum input voltage : 25Vp-p

Withstand voltage : 300Vp-p/1minute

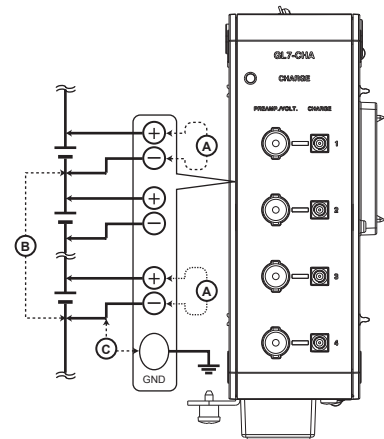

(8) Voltage Output Module (GL7-DCO): Optional

This explains how to connect to the voltage output terminal.

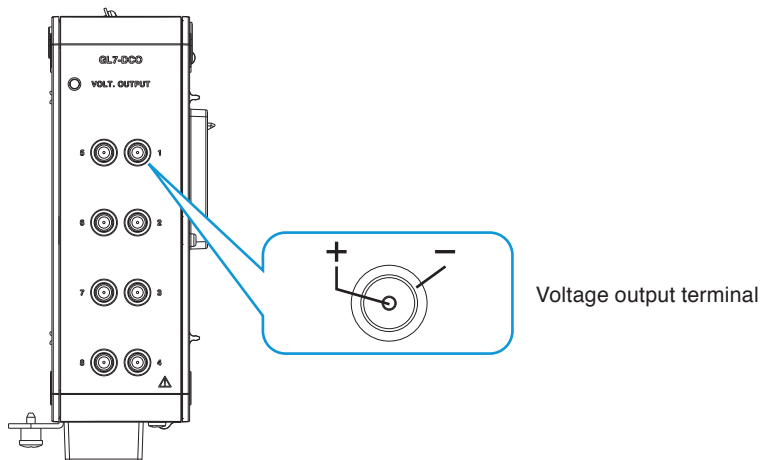

- + High-voltage terminal (Terminal for outputting the high-voltage side of the output signal)
- Low voltage terminal (Terminal for outputting the low-voltage side of the output signal)

⚠ CAUTION

- The external signal should not be input to the voltage output terminal.
- During wiring, confirm that the power of the module is turned OFF.
- The voltage output terminal on this module is not isolated. (GND terminal and common potential)
Also, - terminal (low-voltage) of each ch is connected to all ch.

Connection of Output Signal

When connecting between the voltage output terminal and equipment to be received, the SMA-BNC conversion cable (B-562) sold separately should be used.

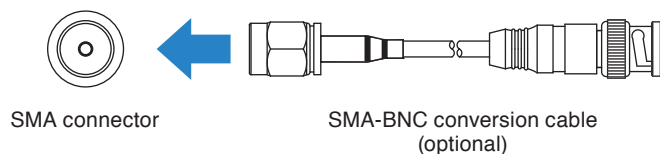

If you do not use the cable sold separately, always connect with the cable that conforms to SMA connector specifications.

⚠ WARNING

Do not apply the external voltage to the voltage output terminal. This module may be damaged.

⚠ CAUTION

- During installation, a 4 kgf.cm screw tightening torque is recommended.
- Do not short-circuit between the + side (high-voltage) and - side (low-voltage) of the voltage output terminal. This module may be damaged.
- When the power is turned on and off, the voltage may be output from the output terminal for 10 ms. If the GL7000 is affected by the output voltage, please disconnect the output cable before the power is turned on or off.
- The load current of the voltage output is $\pm 10\text{mA/ch}$ (The total output current of the modules to be used must be $\pm 40\text{mA}$ or less.).

2.11 Input/output Cable Connection for GL

Trigger and exterior sampling input and trigger output functions can be used by using an output cable for the GL input/output cable (B-513: optional). The alarms are output from the alarm signal output terminal on the Alarm module..

The output cable for the GL input/output cable (B-513: optional) is connected to the REMOTE terminal as shown on the chart below.

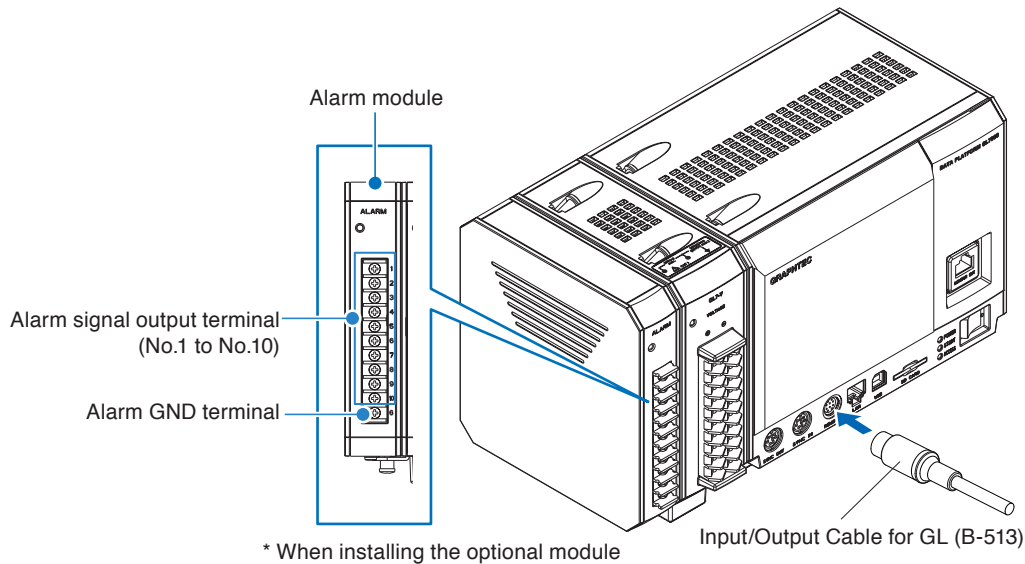

REMOTE terminal input specifications

| Items | Description |
|-------------------------|---|
| Maximum input voltage | 0 to +24 V (single-ended ground input) |
| Input signal | Non-voltage contact (a contact, b contact, NO, NC), Open collector, Voltage input |
| Input threshold voltage | Approx. +2.5 V |
| Hysteresis | Approx. 0.5 V (Approx.+2.5V to Approx.+3V) |

Output specifications

| Items | Description |
|--|---|
| Alarm Signal Output Specifications | Open collector output (pull-up resistance 10K Ω) < Maximum rating of the output transistor > <ul style="list-style-type: none"> • Voltage between collector and GND: 50 V • Collector current: 2.0 A • Collector dissipation: 0.6W |
| REMOTE Signal Output Specifications (TRIGGER Output, etc.) | Open collector output (pull-up resistance 10 K Ω) < Maximum rating of the output transistor > <ul style="list-style-type: none"> • Voltage between collector and GND: 30 V • Collector current: 0.5 A • Collector dissipation: 0.2 W |

* The above are available in the output circuit. These are the highest-rated transistors. When you use them, please leave more than sufficient margin for fluctuations.

Internal equivalent circuit in input/output circuit

REMOTE signal input circuit

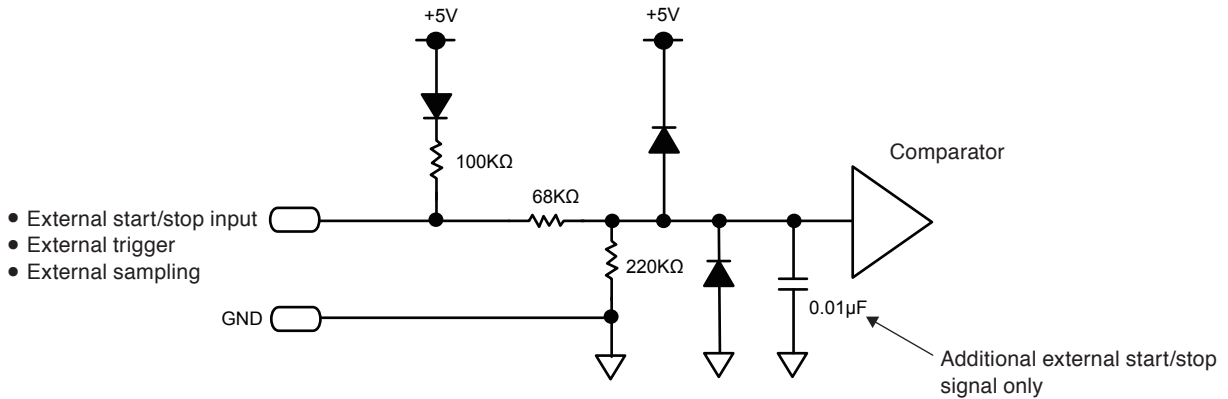

REMOTE signal input circuit

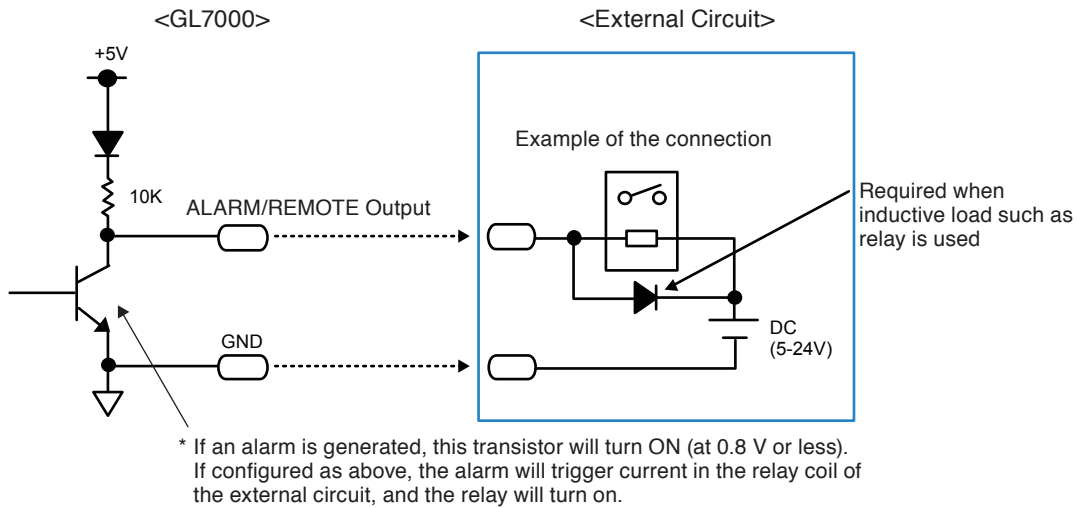

GL input and output cabling

Cable tips are bare tips. Perform wiring for the necessary functions.

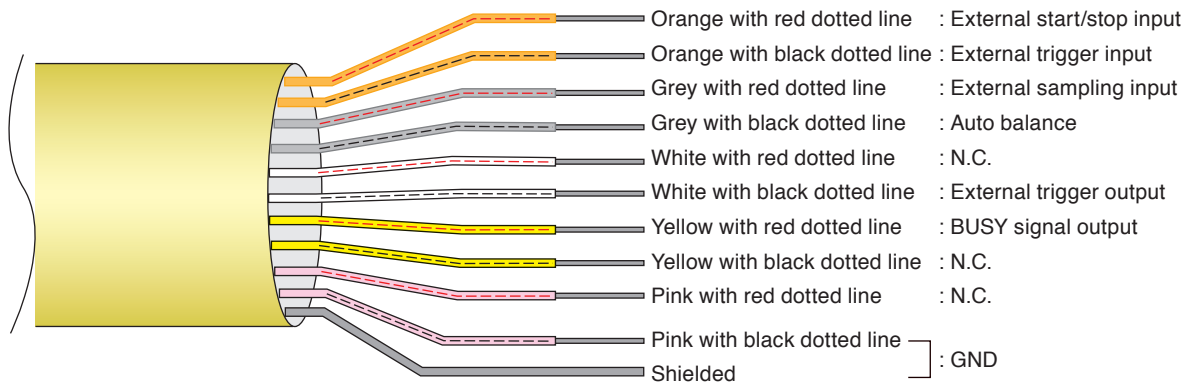

CHECKPOINT

For the cables currently not used and not connected, do not connect anything.

REMOTE Functions

| Signal name | Function | Description |
|---------------------------|--|----------------------------------|
| External start/stop input | Controls the start/stop of the measurement. <ul style="list-style-type: none"> L (0 V, GND short) : starts the measurement. H (5 V, Open) : stops the measurement. | Detection cycle: 10 ms intervals |
| External trigger input | External trigger signal <ul style="list-style-type: none"> The trigger occurs immediately when L (0 V, GND short) is input. When you want to use this function, it is necessary to set the trigger. For details, see "Trigger/Alarm Settings" in page 3-64 | Minimum pulse width: 500 μ s |
| External sampling input | External sampling signal <ul style="list-style-type: none"> When L (0 V, GND short) is input, a point recording is performed. When you want to use this function, it is necessary to set the sampling. For details, see "External Sample" in page 3-50. | Minimum pulse width: 500 ns |
| Auto-balancing input | Perform the auto-balancing remotely. <ul style="list-style-type: none"> When the L (0 V, GND short circuit) is input, the auto-balancing is performed. | Only use the DC strain module. |
| External trigger output | When a trigger is detected, the pulse with L level (0.8 V or less) is output. <Output Pulse Specifications> <ul style="list-style-type: none"> Pulse level: L (0.8 V or less) Pulse width: 500 μs * Both start and stop triggers output a trigger pulse. An interval between the start and stop triggers should be 1 ms or more. | |
| External Busy Output | When the auto-balancing is performed, the BUSY signal is output. <ul style="list-style-type: none"> When the auto-balancing is performed, the L (0 V) signal is output. | Only use the DC strain module. |
| GND | This is a GND for the input and output signals. | |

2.12 Noise Countermeasures

In case the measured values fluctuate due to exogenous noise, the following measures are recommended. (Depending on the type of noise, the result may change.)

- **Make absolutely sure to ground the chassis GND of the equipment to be measured or received (When connecting the GL7-DCO module).**

Absolutely making sure to ground the chassis GND of the measuring object to a favorable ground may have an effect.

- **Connecting the chassis GNDs of this module and the equipment to be measured or received (When connecting the GL7-DCO module).**

Connecting the chassis GND of the measuring object and the GND terminal of the main module with an electrical cable as short and thick as possible, and further gaining potential equalization by grounding it may have an effect.

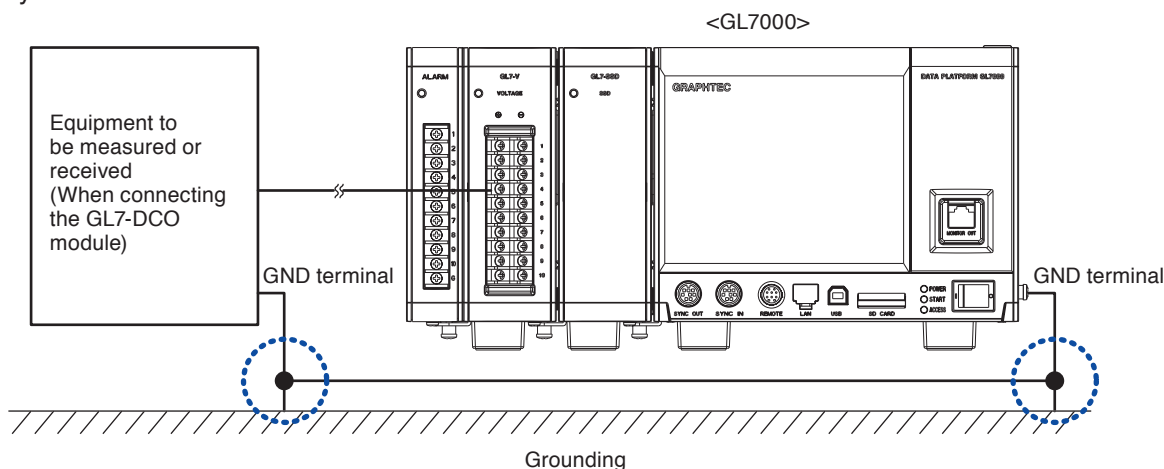

<When Voltage module/High Speed Voltage module/High Voltage module/DC Strain Module /Charge Module is used>

- **Using the filter function of the instrument**

Setting the filter to anything but OFF on the main body's input settings menu.

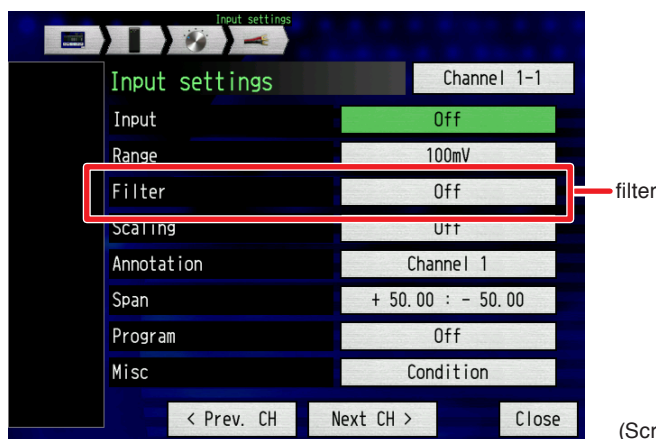

(Screen for when the optional display module is connected)

<When Voltage/Temperature module is used>

- **Using the filter function of the instrument**

Setting the filter to anything but OFF on the main body's input settings menu.

- **Use the sample interval where this module's digital filter becomes effective**

On the Recording settings menu of the main module, set the sample interval to 500 ms or above. Set your commercial power-supply frequency from "Other Settings" in this module.

<When using the Voltage Output Module (GL7-DCO)>

When a filter function is contained in the equipment to be received, the function should be enabled.

CHAPTER 3 Measure and Set

This chapter explains how to measure and set various parameters when an optional Display Module is installed.

- 3.1 Nomenclature
- 3.2 Touch-panel Functions
- 3.3 Explanation of the Common Process Screens
- 3.4 Key Operations
- 3.5 Description of Each Operating Mode
- 3.6 Explanation of the Settings Menu
- 3.7 Web server functions

3.1 Nomenclature

(1) Waveform + Digital Screen

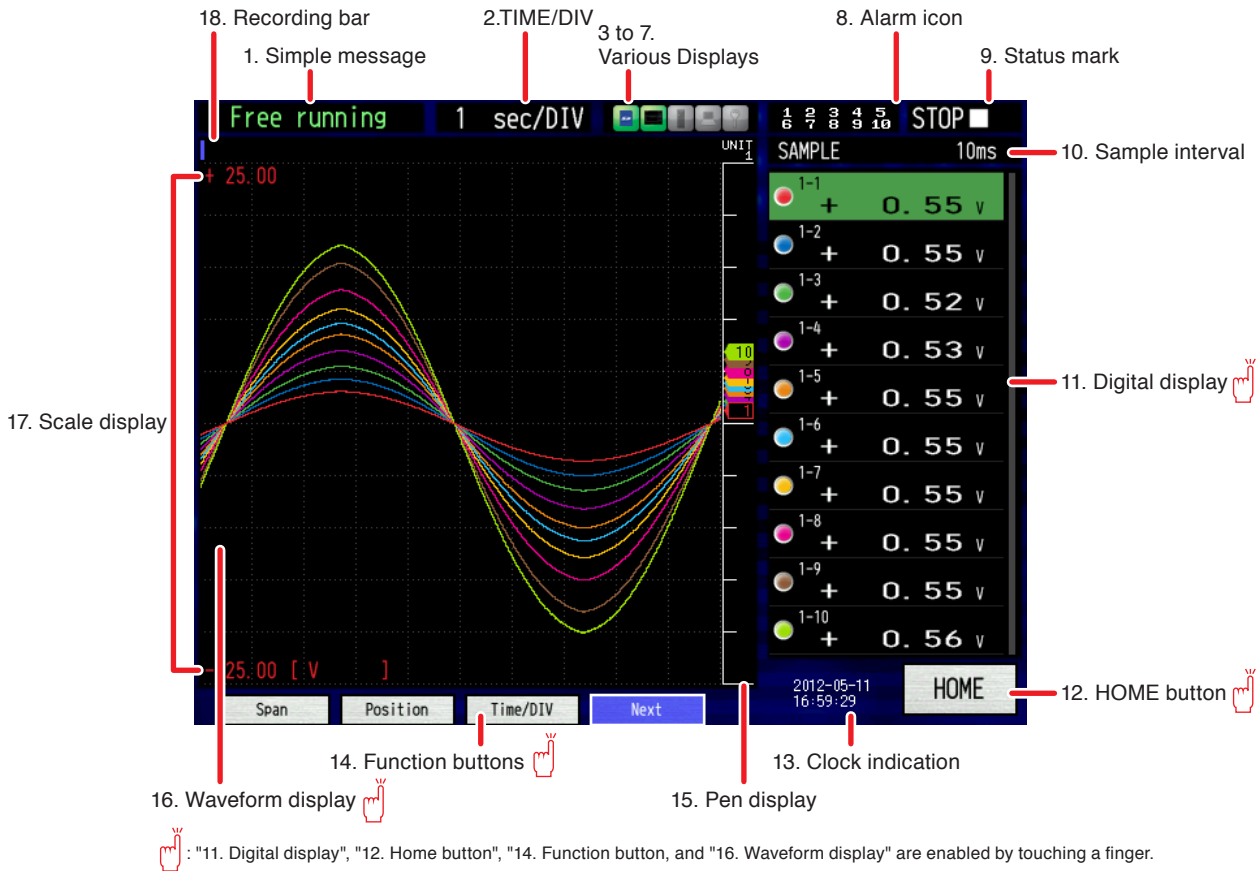

1. Simple message

Displays the active status of the GL7000.

- Free running : Displayed when recording is not performed immediately after turning on the power.
- Armed : Displayed when waiting for a trigger to complete once measuring has begun.
- RAM Recording : Shown when Built-in RAM of each module is in use
- Memory recording : Displayed when data is being recorded the GL7000 internal memory.
- SD Card Recording : Displayed when data is being recorded to the SD card.
- SSD Recording : Displayed when data is being recorded to the SSD.
- Writing Disk : Displayed when recorded data is being writing to the internal memory, SD card, or SSD following recording.
- Finished : Displayed only when a message is displayed if the recording is stopped in the full disk.
- Replaying RAM : Displayed when data within built-in RAM of a module is being replayed.
- Memory review : Displayed when the data recorded in GL7000 internal flash memory is being replayed.
- Replaying SD Card : Displayed when the data recorded in SD card is being replayed.
- Replaying SSD : Displayed when data recorded on an SSD is being replayed.
- Backup Failed : Displayed when backup fails (e.g. the backup destination (SD card) has been removed, etc.).
- Demo wave mode : Displayed when displaying a demo waveform as opposed to measured data.

- * For more information about data recording functions such as trigger and repeat, see the section titled "(5) Trigger/Alarm settings" on page 3-64.
- * For more information about recording memories, see the section titled "(1)-3 Destination" on page 3-50.

CAUTION

- When the message displays "Built-in RAM recording in progress", "Internal memory recording in progress", "SD card recording in progress", "SSD recording in progress", "Writing in progress", please do not turn off the power. This can lead to data being damaged and/or not recorded.
 - Data recorded to the built-in RAM will be erased when the power is turned off. Please save important data on something such as an SD card.
 - Before operating, please make sure that the status marker displays "STOP".
-

2. Time/DIV

Currently time scale is displayed.

3. SD card access displays



: SD card is not present.



: SD card is present, but not being accessed.



: SD card is being properly accessed. Do not remove SD card.

CAUTION

Please do not remove it or turn off the power to the GL7000 when the SD card is being accessed. This can lead to data being damaged and/or becoming inaccessible.

4. Built-in flash memory access displays



: Built-in flash memory is not being accessed.



: Built-in flash memory is being accessed properly.

CAUTION

Please do not turn off the power when accessing the built-in flash memory of the GL7000. This can lead to data being damaged and/or becoming inaccessible.

5. SSD access displays



: SSD module is not mounted.



: SSD module is mounted, but not being accessed.



: SSD module is mounted properly.

CAUTION

Please don't turn off the power to the GL7000 when the SSD Module is being accessed. This can lead to data being damaged and/or becoming inaccessible.

6. Remote displays



: Local. Operations that can be carried out from the GL7000.



: Remote. With the exception of some functions, operations can be carried out from the PC. When closing the connection to the GL7000 application (GL-Connection), it is automatically returned to local mode. If it does not automatically enter local mode, please press the "QUIT" key.

7. Key-lock displays



: Key-lock is not in use. Normal operations may be carried out.



: Key-lock is in use. All keys are locked.

By pressing the LOCK key (refer to the section titled "(5) LOCK" on page 3-42), the key-lock can be set or cleared. A password can also be set in order to clear the key-lock. For details, see the section labeled "Set and clear the key-lock with the password" on page 3-43.

8. Alarm displays

Displays the alarm output status.

The number where an alarm occurred is displayed in red. Further, the channel with the alarm turns red on the input value on the digital display.

9. Status mark



: Displayed when data is being neither recorded nor replayed.



: Displayed when data is being recorded.



: Displayed when data is being replayed.



: Displayed when replaying on the double-screen display.

CAUTION

- Please do not turn off the power or remove the SD card when the status mark is displaying anything other than "STOP". This can lead to data being damaged and/or becoming inaccessible.
- Data recorded to the built-in RAM will be erased when the power is turned off. Please save important data on something such as an SD card.
- Please operate after making sure that "STOP" is being displayed.

10. Sample interval

Current sample interval setting is displayed.

11. Digital displays

Input value of each channel is displayed. Annotation and waveform color also are displayed.

Waveform s can be controlled by touching the waveform display section. By touching the waveform display part, wave processing is performed. For details, see "16. Waveform display" on page 3-5.

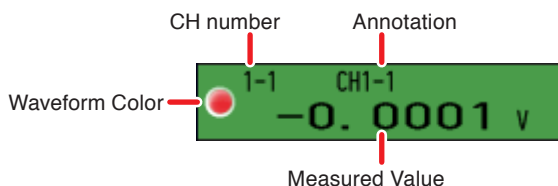

Waveform Color : The waveform color currently set. (For details, see "(11) Input settings" on page 3-78.)

CH Number : The number displayed corresponds to the module number – channel number.

Annotation : Displays the inputted annotation. (For details, see "(11) Input settings" on page 3-78.)

Measured Value : Displays the measured value.

12. HOME button

Pressing this button displays HOME menu. For details, see "(2) HOME screen on page 3-7.

13. Clock

Displays current date and time. For more information about how to set date and time, see "(9) Date/Time settings" on page 3-73.

14. Function buttons

The function of the Function button is changed each time you touch the "Next" as follows

* Displayed item depends on the operation mode.

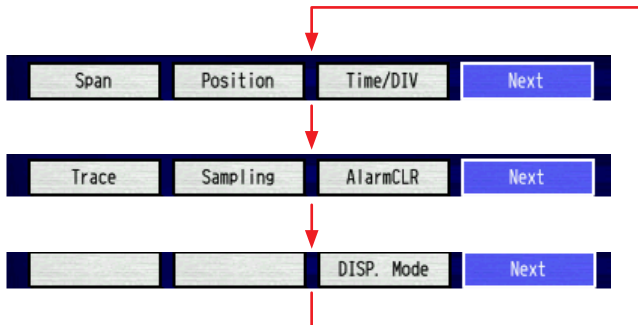

Time/DIV : Changes the time scale. (For details, see "(14) Waveform setting (Simple Waveform Setting)" on page 3-112).

Position : Changes the display position of the waveform. (For details, see "(14) Waveform setting (Simple Waveform Setting)" on page 3-112).

Span : Changes the amplitude of the waveform. (For details, see "(14) Waveform setting (Simple Waveform Setting)" on page 3-112).

Alarm clear : Clears the retained alarms when the Alarm setting is set to "Alarm retention".

Sampling : Changes the sampling rate. (For details, see "(1) Record settings" on page 3-48).

Trace : Selects whether to display the waveform or not. (For details, see "(14) Waveform setting (Simple Waveform Setting)" on page 3-112).

Display mode : Changes the display mode. (For details, see "(15) Display settings" on page 3-114).

15. Pen display

The signal position, trigger position, and range of alarm for each channel are displayed.

16. Waveform display

Displays waveform of input signal.

Control of the following can be done by touching the waveform display.

- Changing position of the selected channel
 - : Slide up or down while touching a single point.
- Changing the span of the selected channel
 - : Spreading apart two points up and down will increase span. Pulling the two points together will decrease the span.
- Changing the timescale
 - : Spreading apart two points left and right will make the timescale faster. Pulling the two points together will make the timescale slower.

* By touching the digital display part, the channel can be selected.

17. Scale display

Displays the upper/lower limit scale of the currently displayed channel(s).

18. Recording bar

- (1) During data recording
Displays time elapsed and current memory usage.

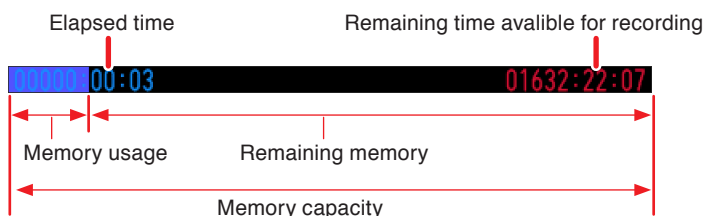

For example, for a 2GB SD card, where approx. 768MB is being used, the memory capacity is 2GB, used memory is approx. 768MB, and the remaining memory is approx. 1.25GB. As recording time elapses, the memory used increases and the remaining memory decreases.

Remaining time available for recording displays the amount of time recordable in accordance to the remaining free memory. However, if the remaining memory exceeds 2GB, remaining recordable time displays 1 file of 2GB.

CHECKPOINT

- If available recording time exceeds 99999 hours, "++++:++:++" is displayed. If the time passed exceeds 99999 hours, "++++:++:++" is displayed.
- When recording with CSV format, the capacity varies depending on the measured value. For that reason, the error in the recordable time occurs.

- (2) During data replaying
Display and cursor positions are illustrated.

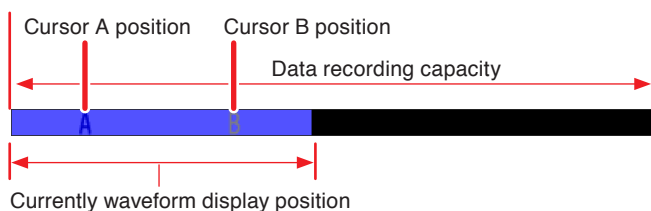

(2) HOME screen

The home screen is displayed when the home key is touched.
Icons allowing each operation is displayed

* The displayed content varies on connected amplifier and option modules.

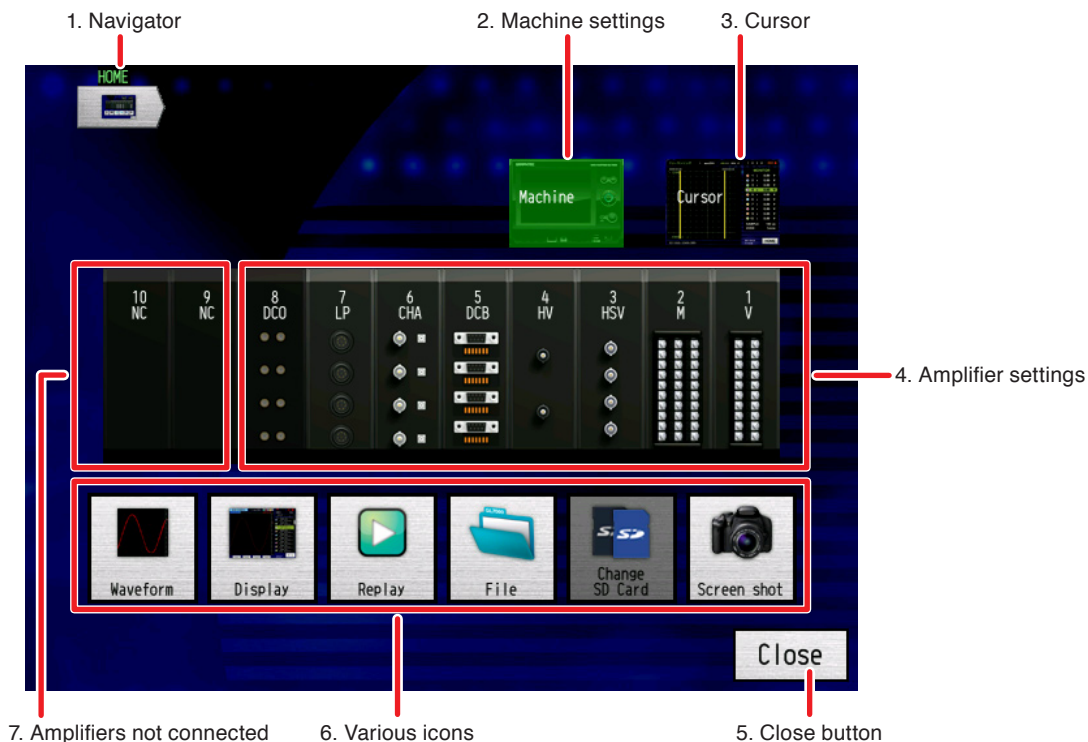

1. Navigator

Hierarchy of the current screen is displayed. Pressing an icon returns to that icon's screen.

2. Machine settings

Change settings that relate to the main module. The following can be set when this icon is pressed.

- Data Settings : Sets the sampling rate and other recording settings.
(For details, see "(1) Record settings" on page 3-48, "(2) Marker settings" on page 3-56, and "(3) Backup settings" on page 3-57.)
- Network Settings : Sets the IP configuration and other network settings.
(For details, see "(7) IP settings" on page 3-69, and "(8) FTP server settings" on page 3-71.)
- Date/Time Settings : Sets the date and time.
(For details, see "(9) Date/Time settings" on page 3-73.)
- Factory Initializing : Resets settings to the factory default.
- Trigger/Alarm settings: Sets trigger and alarm settings.
(For details, see "(5) Trigger/Alarm settings" on page 3-64.)
- I/F USB Settings : Sets settings related to the USB interface.
(For details, see "(6) I/F, USB settings" on page 3-68.)
- Other Settings : Sets miscellaneous settings such as language and screensavers.
(For details, see "(10) Other settings" on page 3-75.)

3. Cursor

Cursor operation and data retrieval is carried out from this screen. This icon is appears whenever data is replayed.

4. Amplifier settings

Displays currently connected amplifiers. Pressing this icon allows for the input, trigger level and alarm settings to be changed.

5. Close button

Touching this button returns to the previous settings screen.

6. Various icons

Pressing the various icons leads to the setting screens below.

- Waveform Display Settings : Sets the waveform and timescale settings among others.
(For details, see "(14) Waveform setting (Simple Waveform Setting)" on page 3-112).
- Display Settings : Sets the display mode and calculation settings among others.
(For details, see "(15) Display settings" on page 3-114).
- Replay : Replays the recorded data.
(For details, see "(16) Replay setting screen (Data relapying screen)" on page 3-129).
- File : Allows management of formatting, read conditions and other file related tasks.
(For details, see "(17) File operations" on page 3-129, "(18) Data Save" on page 3-130 and "(19) Save/Load current settings" on page 3-132).
- Change SD Card : Allows SD Card exchange during recording.
Available when recording above a 100ms sampling rate.
(For details, see "(20) Swapping out the SD card" on page 3-134).
- Screenshot : The current waveform displayed is saved with a BMP or PNG format.
The waveform when the Screenshot button is touched is saved.

7. Amplifiers not connected

Displays amplifiers that are not currently connected. This icon may not be changed.

(3) Navigator

The navigator shows the user's current position in the menu tree. One icon at a time is displayed on the screen for each hierarchy level as shown on the chart below. By pressing an icon, you can quickly return to the indicated screen.

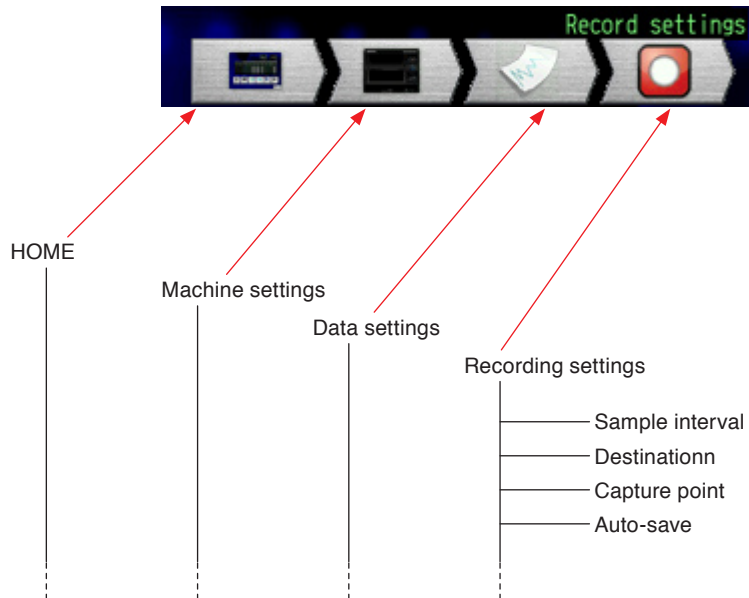

(4) Menu screen

The menu screen displays the middle hierarchy; By pressing the icons, the following menu is displayed, or it is possible to move to the settings screen.

The content of the system settings screen is explained as an example.

When the GL7000 setting icon on the Home screen is touched, the Machine settings screen is displayed.



1. Navigator

Hierarchy of the current screen is displayed. Pressing an icon returns to that icon's screen.

2. Various icons

Pressing the various icons leads to the settings screen and to a menu screen featuring the hierarchy below.

3. Close button

Press this button to return to the previous screen.

4. Title

The title of the currently displayed screen.

(5) Settings screen

The values of the current settings are displayed in the settings screen.

The values set may be changed by touching the setting value.

As an example, the input setting screen is explained.

When "Amplifier settings" → "Channel settings" → "Settings" button on the Home screen are touched in order, Input settings screen is displayed.

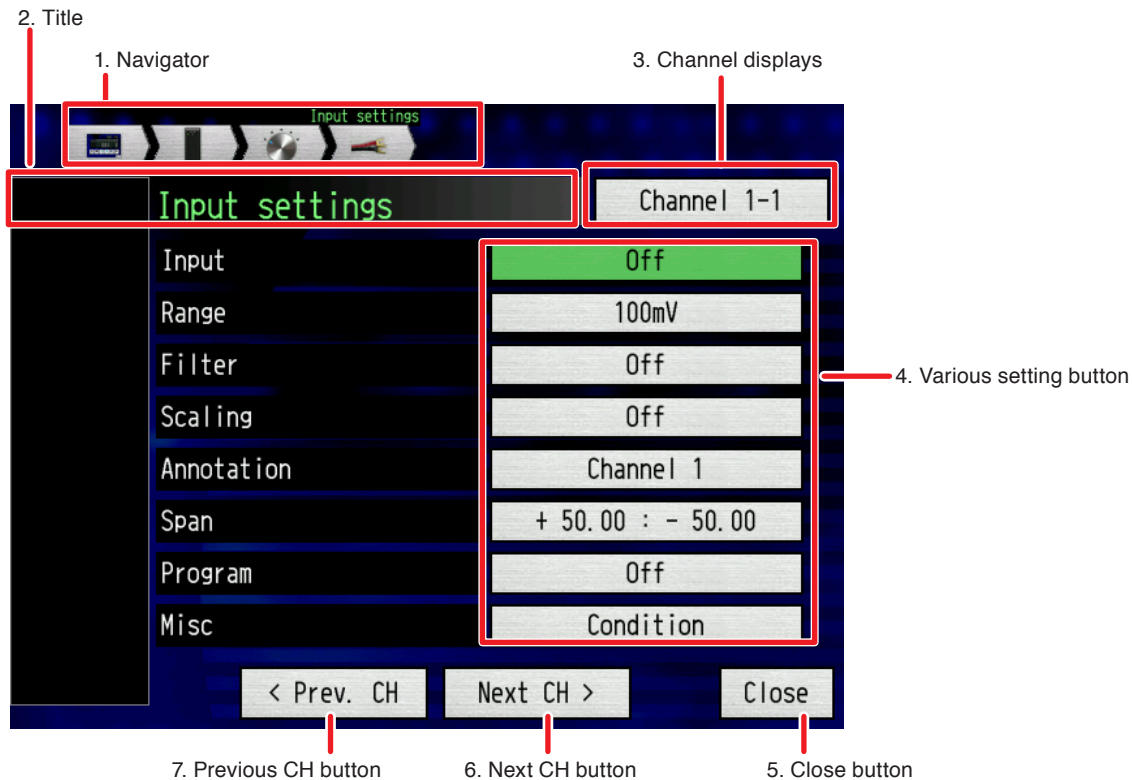

1. Navigator

Hierarchy of the current screen is displayed. Pressing an icon returns to that icon's screen.

2. Title

The title of the currently displayed screen.

CHECKPOINT

The Next CH button and Previous CH button are only displayed on settings screens that are related to the CHs of the amplifiers.

3. Channel displays

The currently set channel is displayed. Touching this button moves the users to the channel selection screen, and from that list it is possible to reselect the channel to set.

These buttons allow users to change the settings of another channel without having to return to the menu hierarchy.

4. Various setting buttons

Buttons for each settings item. Displayed inside the button are the current settings. By pressing this button, the user is moved to the Set Item selection screen and the screen for entering character and numerical value settings.

After pressing this button, it is possible to press another button that lets the user edit more detailed settings.

CHECKPOINT

Among the Set Items there are also items that are only displayed when certain conditions are met.

5. Close button

Press this button to return to the previous screen.

6. Next CH button

Touching this button moves the user to the CH settings screen for the next CH.

This button allows users to change the settings of the next channel without having to return to the menu hierarchy.

7. Previous CH button

Touching this button moves the user to the CH settings screen for the prev. CH.

This button allows users to change the settings of the prev. channel without having to return to the menu hierarchy.

(6) Menu tree

Here the whole menu tree is displayed. On this menu tree you can search for where items you want to set are located.

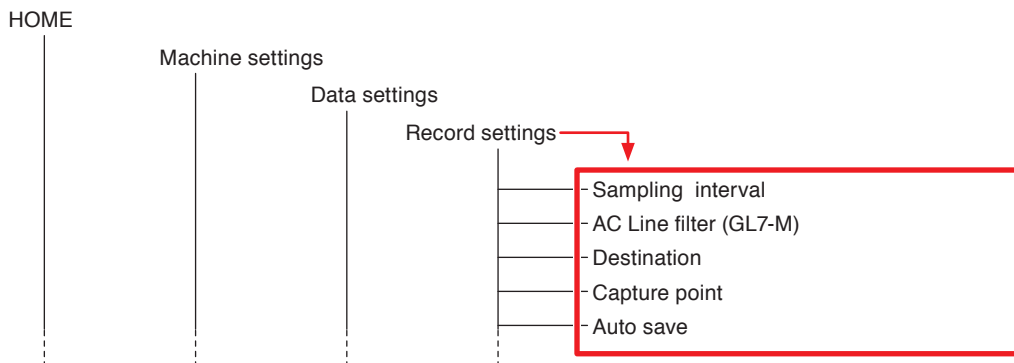

Pressing the "Capture" icon moves the user to a settings screen with set items such as "Sample Interval" (the red framed part on the chart above).

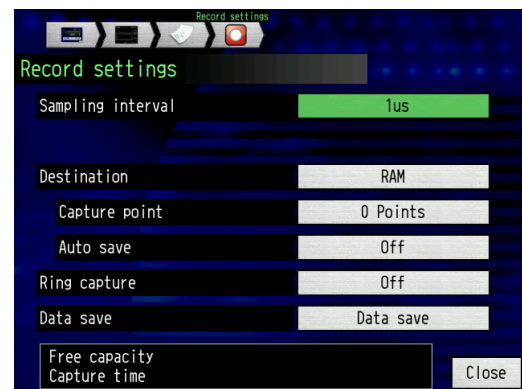
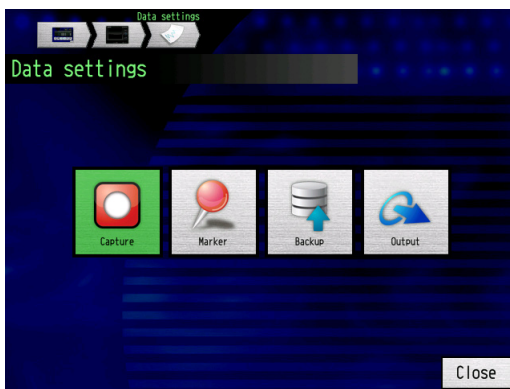



* Output settings: Displayed when the GL7-DCO module is installed.

CHECKPOINT

Among the Set Items there are also items that are only displayed when certain conditions are met.

An explanation of the symbols listed in the menu tree will be given on the next page.

 **Select** : Touching the setting value that has this icon will display a list to a separate screen where that the setting values can be selected.

 **Execute** : Pressing the setting for an item that has this symbol will execute its contents.

 **Numerical Value** : Pressing the setting for an item that has this symbol will open the numerical entry screen.

 **Character** : Pressing the setting for an item that has this symbol will open the character entry screen.

 **File** : Pressing the setting for an item that has this symbol will open the file operations screen.

| | Symbols | References |
|---|--|------------|
| HOME | | |
| Machine settings | | |
| Data settings | | P.3-48 |
| Record settings | | |
| Sample interval | <input type="radio"/> Select | |
| AC Line filter | <input type="radio"/> Select | |
| Destination | <input type="radio"/> Select | |
| Capture point | <input type="text" value="1 Numerical Value"/> | |
| Auto save | <input type="radio"/> Select | |
| Ring capture | | |
| Ring capture | <input type="radio"/> Select | |
| Data points | <input type="text" value="1 Numerical Value"/> | |
| Data save | | |
| File name | <input type="text" value="File"/> | |
| Name type | <input type="radio"/> Select | |
| File type | <input type="radio"/> Select | |
| Marker settings | | |
| Marker (markers 1 to 8) | <input type="text" value="A Character"/> | |
| Marking (each marker) | <input type="text" value="Execute"/> | |
| Backup settings | | |
| Backup intervals | <input type="radio"/> Select | |
| Backup destination | <input type="radio"/> Select | |
| Save folder | <input type="text" value="A Character"/> | |
| Output settings (* Displayed when the Voltage Output Module is installed.) | | |
| DCO module settings (To Voltage Output Module (GL7-DCO) in each amplifier module (G)) | | |
| Start / Stop synchronization | <input type="radio"/> Select | |
| Repeat output | <input type="radio"/> Select | |
| Emergency stop alarm CH output | <input type="radio"/> Select | |
| Output level at the time of Stop | <input type="radio"/> Select | |
| Data load | <input type="text" value="Execute"/> | |
| Start output | <input type="text" value="Execute"/> | |
| Trigger/Alarm settings | | P.3-64 |
| Start source | <input type="radio"/> Select | |
| Level settings | to (A) | |
| Logic settings | to (B) | |
| Alarm port number | <input type="radio"/> Select | |
| Date setting | | |
| Date | <input type="text" value="1 Numerical Value"/> | |
| Time | <input type="text" value="1 Numerical Value"/> | |
| Weekly settings | | |
| Day (Sunday to Saturday) | <input type="radio"/> Select | |
| Time | <input type="text" value="1 Numerical Value"/> | |
| Time settings | | |
| Time | <input type="text" value="1 Numerical Value"/> | |
| Stop source | <input type="radio"/> Select | |
| Level settings | to (A) | |
| Logic settings | to (B) | |
| Alarm port number | <input type="radio"/> Select | |
| Date setting | | |
| Date | <input type="text" value="1 Numerical Value"/> | |
| Time | <input type="text" value="1 Numerical Value"/> | |
| Weekly settings | | |
| Day (Sunday to Saturday) | <input type="radio"/> Select | |
| Time | <input type="text" value="1 Numerical Value"/> | |
| Time settings | | |
| Time | <input type="text" value="1 Numerical Value"/> | |
| Repeat | <input type="radio"/> Select | |
| Repeat interval | <input type="text" value="1 Numerical Value"/> | |
| Pretrigger points | <input type="text" value="1 Numerical Value"/> | |
| Alarm hold | <input type="radio"/> Select | |
| Burnout alarm | <input type="radio"/> Select | |

| | Symbols | References |
|--------------------------|--|------------|
| Network settings | | |
| IP settings | | P.3-69 |
| IP address auto acquire | <input type="radio"/> Select | |
| IP address | <input type="text" value="1"/> Numerical Value | |
| Subnet mask | <input type="text" value="1"/> Numerical Value | |
| Port number | <input type="text" value="1"/> Numerical Value | |
| Gateway | <input type="text" value="1"/> Numerical Value | |
| DNS address | <input type="text" value="1"/> Numerical Value | |
| Keep alive | <input type="radio"/> Select | |
| ID Name | <input type="text" value="A"/> Character | |
| Restart network | <input type="button" value="Execute"/> | |
| FTP server settings | | |
| FTP server | <input type="text" value="A"/> Character | |
| User name | <input type="text" value="A"/> Character | |
| Pass word | <input type="text" value="A"/> Character | |
| Port number | <input type="text" value="1"/> Numerical Value | |
| PASV Mode | <input type="radio"/> Select | |
| Connection test | <input type="button" value="Execute"/> | |
| I/F, USB settings | | P.3-68 |
| New line Code | <input type="radio"/> Select | |
| USB ID | <input type="text" value="1"/> Numerical Value | |
| USB Drive mode select | <input type="radio"/> Select | |
| Date/Time settings | | P.3-73 |
| Date | <input type="text" value="1"/> Numerical Value | |
| Time | <input type="text" value="1"/> Numerical Value | |
| Apply | <input type="button" value="Execute"/> | |
| Internet time | <input type="radio"/> Select | |
| NTP server | <input type="text" value="A"/> Character | |
| Time zone | <input type="radio"/> Select | |
| Synchronization interval | <input type="radio"/> Select | |
| Adjust mode | <input type="radio"/> Select | |
| Connection test | <input type="button" value="Execute"/> | |
| Other settings | | P.3-75 |
| LCD brightness | <input type="radio"/> Select | |
| Screen saver | <input type="radio"/> Select | |
| Power on start | <input type="radio"/> Select | |
| AC Line cycle | <input type="radio"/> Select | |
| Temperature setting | <input type="radio"/> Select | |
| Temperature unit | | |
| Room temperature | | |
| Burn out | | |
| Key click | <input type="radio"/> Select | |
| Language | <input type="radio"/> Select | |
| Information | <input type="radio"/> Select | |
| Demo waveform | <input type="radio"/> Select | |
| Factory Init. | | |

| | Symbols | References |
|----------------------------------|--|------------------------------|
| (Each Amplifier Module) | | |
| Channel settings | | |
| ALL | | |
| Input | <input type="radio"/> Select | |
| Range | <input type="radio"/> Select | |
| Filter | <input type="radio"/> Select | |
| Span | | |
| Upper limit/Lower limit | <input type="text" value="1 Numerical Value"/> | |
| Apply | <input type="button" value="Execute"/> | |
| Input settings (Each CH) | | P.3-78 |
| Input | <input type="radio"/> Select | P.3-91 |
| Range | <input type="radio"/> Select | P.3-93 |
| Filter | <input type="radio"/> Select | P.3-97 |
| Slope | <input type="radio"/> Select | P.3-92 |
| Scaling settings | | P.3-100 |
| Scaling | <input type="radio"/> Select | |
| Meas. Value (Upper/ Lower) | <input type="text" value="1 Numerical Value"/> | |
| Scal. Value (Upper/ Lower) | <input type="text" value="1 Numerical Value"/> | |
| Adjust (Meas. Value) | <input type="text" value="1 Numerical Value"/> | |
| Adjust (Scal. Value) | <input type="text" value="1 Numerical Value"/> | |
| Read current | <input type="button" value="Execute"/> | |
| Meas. Value | <input type="text" value="1 Numerical Value"/> | |
| Scal. Value | <input type="text" value="1 Numerical Value"/> | |
| Select (Categories) | <input type="radio"/> Select | |
| Select (Unit selection) | <input type="radio"/> Select | |
| Unit | <input type="text" value="A Character"/> | |
| Apply | <input type="button" value="Execute"/> | |
| Annotation | <input type="text" value="A Character"/> | P.3-101 |
| Span | | P.3-101 |
| Upper/Lower | <input type="text" value="1 Numerical Value"/> | |
| Apply | <input type="button" value="Execute"/> | |
| Inter-CH operation settings | | P.3-102 |
| Inter-CH Op. | <input type="radio"/> Select | |
| Operation | <input type="radio"/> Select | |
| Scaling | <input type="radio"/> Select | |
| Calculation span (Upper level) | <input type="text" value="1 Numerical Value"/> | |
| Calculation span (Decimal point) | <input type="radio"/> Select | |
| Calculation span (Lower level) | <input type="text" value="1 Numerical Value"/> | |
| Select Unit(Categories) | <input type="radio"/> Select | |
| Select Unit(Select) | <input type="radio"/> Select | |
| Unit | <input type="text" value="A Character"/> | |
| Apply | <input type="button" value="Execute"/> | |
| Other settings | | P.3-103 |
| Waveform Color Setting | | |
| Color settings | <input type="text" value="1 Numerical Value"/> | |
| Confirm | <input type="button" value="Execute"/> | |
| Thickness setting | <input type="radio"/> Select | |
| Perform auto zero ADJ. | <input type="button" value="Execute"/> | |
| Reset auto zero ADJ. | <input type="button" value="Execute"/> | |
| DC Strain Module to (E) | | |
| Charge Module to (F) | | |
| Trigger | | to Trigger/Alarm settings |
| Alarm level settings | | to (C) |
| Voltage Output module settings | | Voltage Output module to (G) |

| | Symbols | References |
|--|--|------------|
| <ul style="list-style-type: none"> Waveform setting <ul style="list-style-type: none"> Span/Position/Trace <ul style="list-style-type: none"> ↑ ↓ ↑ • ↓ ↓ • ↑ Trace Zone setting Time/DIV | <ul style="list-style-type: none"> ▶ Execute ▶ Execute ▶ Execute ▶ Execute ▶ Execute ▶ Execute ○ Select ○ Select | P.3-112 |
| <ul style="list-style-type: none"> Display settings <ul style="list-style-type: none"> Display mode Span settings <ul style="list-style-type: none"> Upper/Lower Apply Pulse span settings <ul style="list-style-type: none"> Upper/Lower Apply Zone setting Format XY display settings <ul style="list-style-type: none"> Trace X-Axis Y-Axis Color <ul style="list-style-type: none"> Color settings Confirm Trace settings <ul style="list-style-type: none"> Trace settings (Each CH) Caic. setting 1 Caic. setting 2 FFT Display settings | <ul style="list-style-type: none"> ○ Select 1 Numerical Value ▶ Execute 1 Numerical Value ▶ Execute ○ Select ○ Select ○ Select ○ Select ○ Select ○ Select ○ Select ○ Select 1 Numerical Value ▶ Execute ○ Select ○ Select ○ Select | P.3-114 |
| <ul style="list-style-type: none"> Replay <ul style="list-style-type: none"> Source File name Replay | <ul style="list-style-type: none"> ○ Select 📁 File ▶ Execute | P.3-129 |
| <ul style="list-style-type: none"> File <ul style="list-style-type: none"> File operations Data save <ul style="list-style-type: none"> File name Name type File type Save Range Save Save/Load current settings <ul style="list-style-type: none"> File name (Save settings) Name type Save File name (Load settings) Load | <ul style="list-style-type: none"> 📁 File ○ Select ○ Select ○ Select ▶ Execute 📁 File ○ Select ▶ Execute 📁 File ▶ Execute | P.3-129 |

| | Symbols | References |
|---------------------------|--|------------|
| Swapping out the SD card | <input type="button" value="▶ Execute"/> | P.3-134 |
| Screenshot | <input type="button" value="File"/> | P.3-136 |
| File name | <input type="button" value="○ Select"/> | |
| Name type | <input type="button" value="○ Select"/> | |
| File type | <input type="button" value="▶ Execute"/> | |
| Save | <input type="button" value="▶ Execute"/> | |
| Cursor | | P.3-137 |
| Cursor position | | |
| Move to first | <input type="button" value="▶ Execute"/> | |
| Move to center | <input type="button" value="▶ Execute"/> | |
| Move to last | <input type="button" value="▶ Execute"/> | |
| Move to trigger | <input type="button" value="▶ Execute"/> | |
| Move to selected position | <input type="button" value="○ Select"/> | |
| Move position | <input type="button" value="▶ Execute"/> | |
| Move date/time | <input type="button" value="1 Numerical Value"/> | |
| Move | <input type="button" value="1 Numerical Value"/> | |
| Cursor sync | <input type="button" value="○ Select"/> | |
| A-cursor/B-cursor | <input type="button" value="▶ Execute"/> | |
| Call other cursor | <input type="button" value="▶ Execute"/> | |
| Data search | | |
| Channel type | <input type="button" value="○ Select"/> | |
| Channel | <input type="button" value="○ Select"/> | |
| Mode | <input type="button" value="○ Select"/> | |
| Level | <input type="button" value="1 Numerical Value"/> | |
| Prev. search | <input type="button" value="▶ Execute"/> | |
| Next search | <input type="button" value="▶ Execute"/> | |
| Action screen | | |
| Statistical calculation | <input type="button" value="▶ Execute"/> | |

(E) Other (DC strain module)

P.3-103

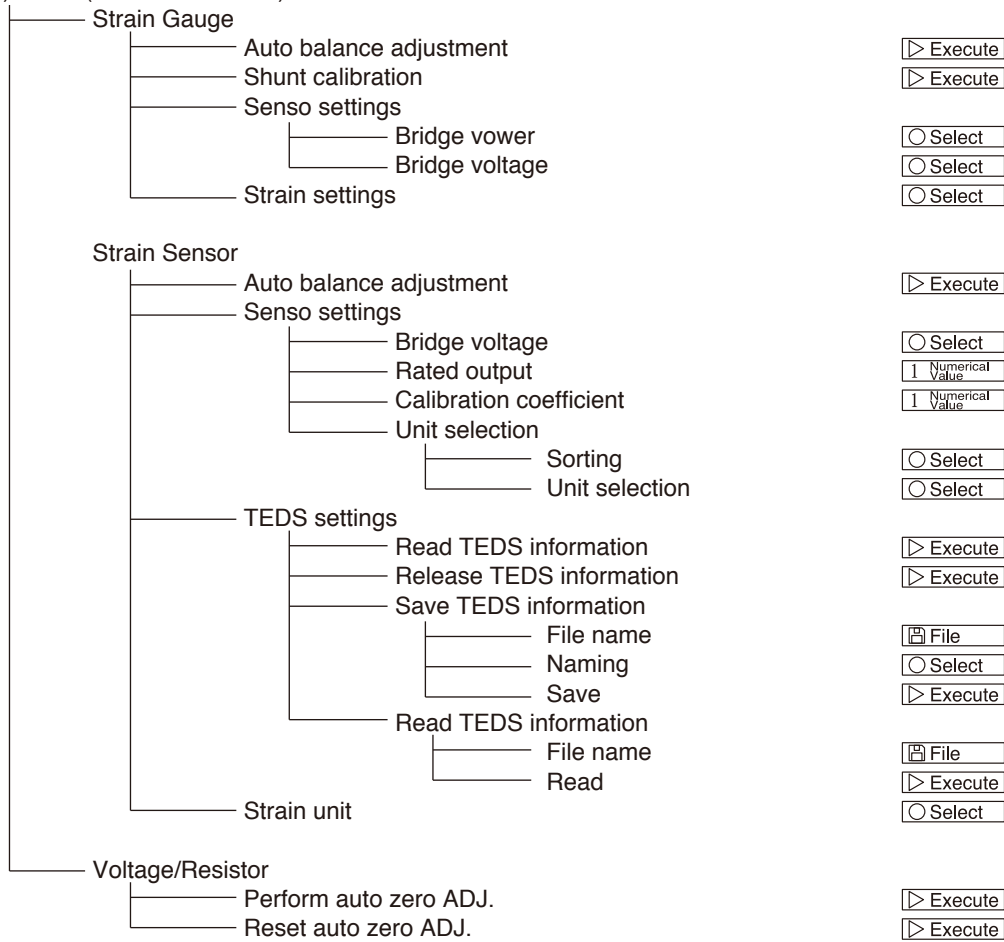

(F) Other (Charge module)

P.3-104

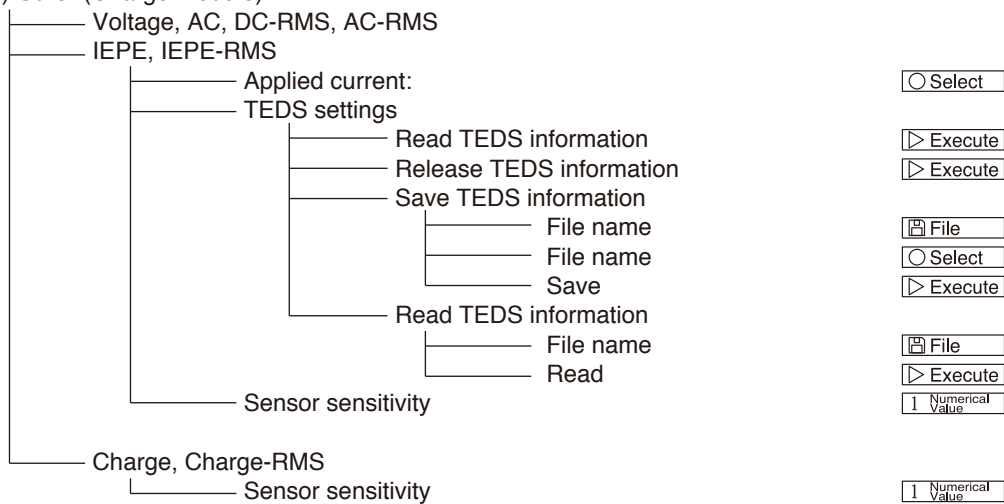

(G) Voltage Output module

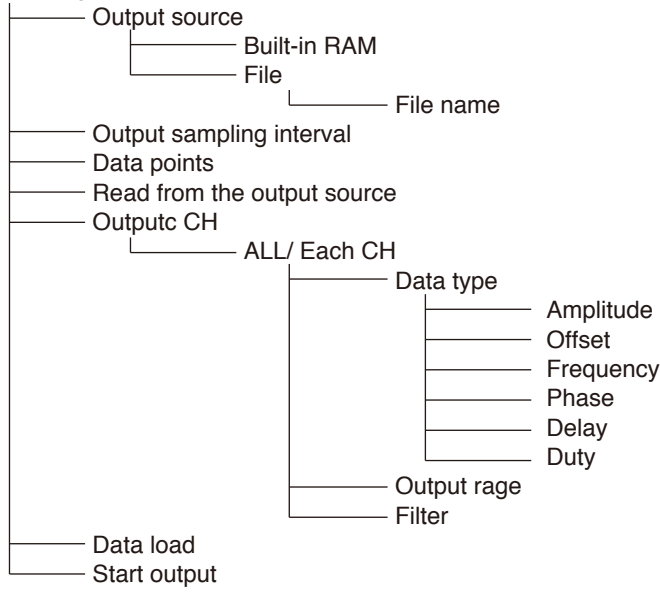

Symbols

References

P.3-144

- Select
- Select
-
- Select
-
-

- Select
-
-
-
-
-
-
- Select
- Select
-
-

3.2 Touch-panel Functions

The GL7000 uses a capacitive touch-panel. Operations can be performed by pressing the screen with your finger.

Here, basic operations, numerical entry and other shared operations using the touch-panel are described. Since this is a capacitive touch screen, touching it with a pen or the like will yield no response. Please remove gloves etc. and operate it with your fingers.

Please note that operating the touch screen with a pointed object may damage it.

(1) Select a setting item

Touch an icon with your finger and it will change to the hierarchy screen below.

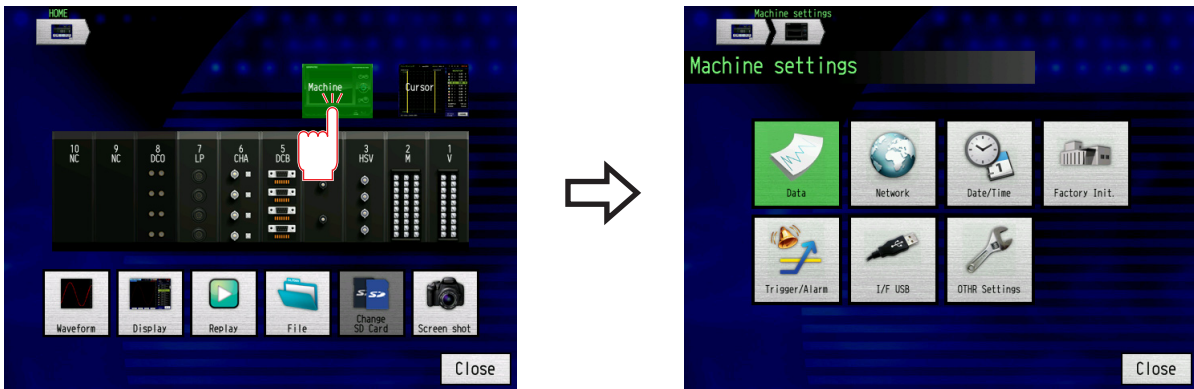

(2) Select a setting item

For selecting an item, it will be selected; it will turn green if touched once.

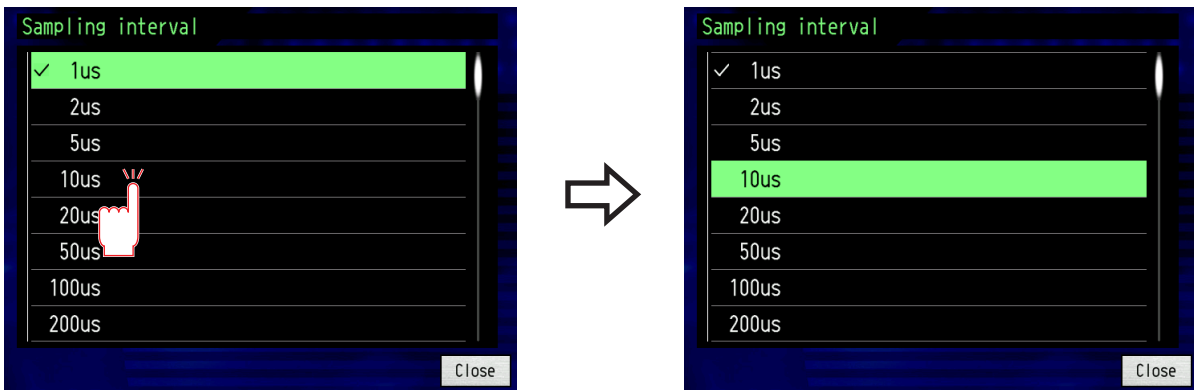

By touching a green item again, the selection is confirmed and set (In this example, it returns to the previous screen after confirmation).

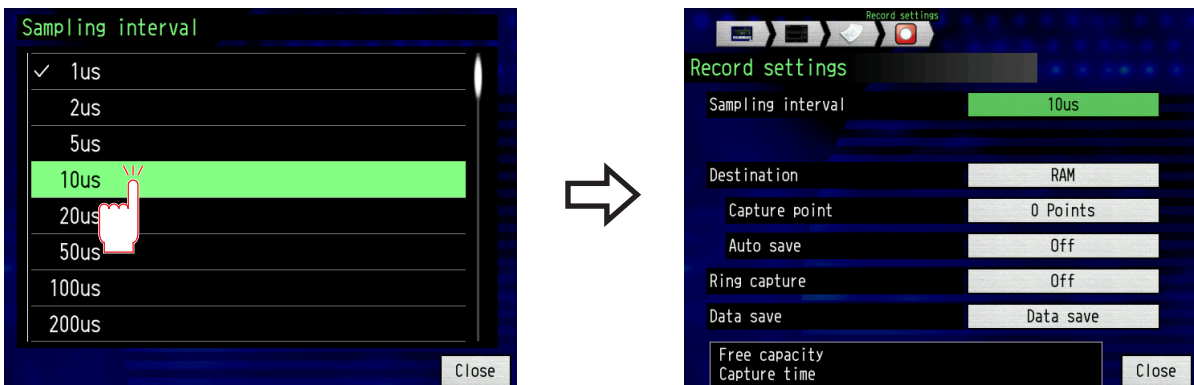

Should there be so many items that they cannot be displayed on one screen a scroll bar will be displayed on the right side. The white knob on the scroll bar displays the current display position.



By touching a spot with no knob, or dragging the knob (keeping the finger pressed down and move by tracing your finger), the position of the knob can be changed and the display can be scrolled.

<Touch a Knob>

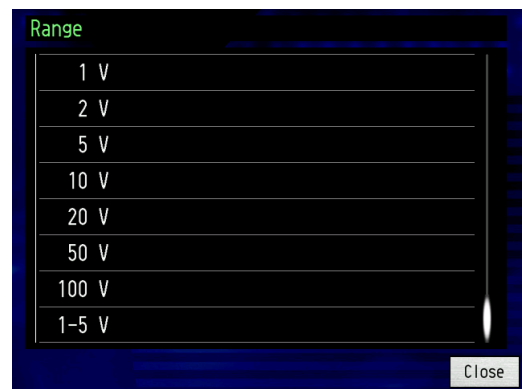
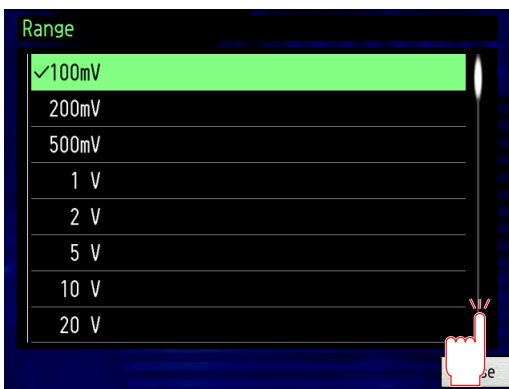

<Drag a Knob>

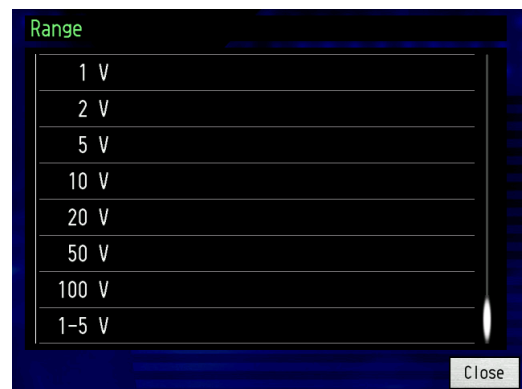
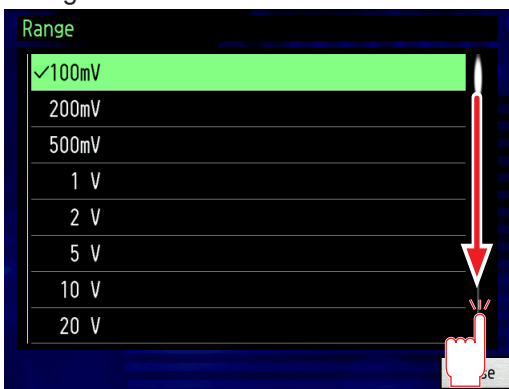

CHECKPOINT

You can also scroll by dragging within the frame in which the selection items are displayed.

3.3 Explanation of the Common Process Screens

This explains the common process screens such as the numeric entry screen and the file box screen. These screens appear on various places of the settings menu, such as when entering numerical values and characters.

(1) Numerical entry

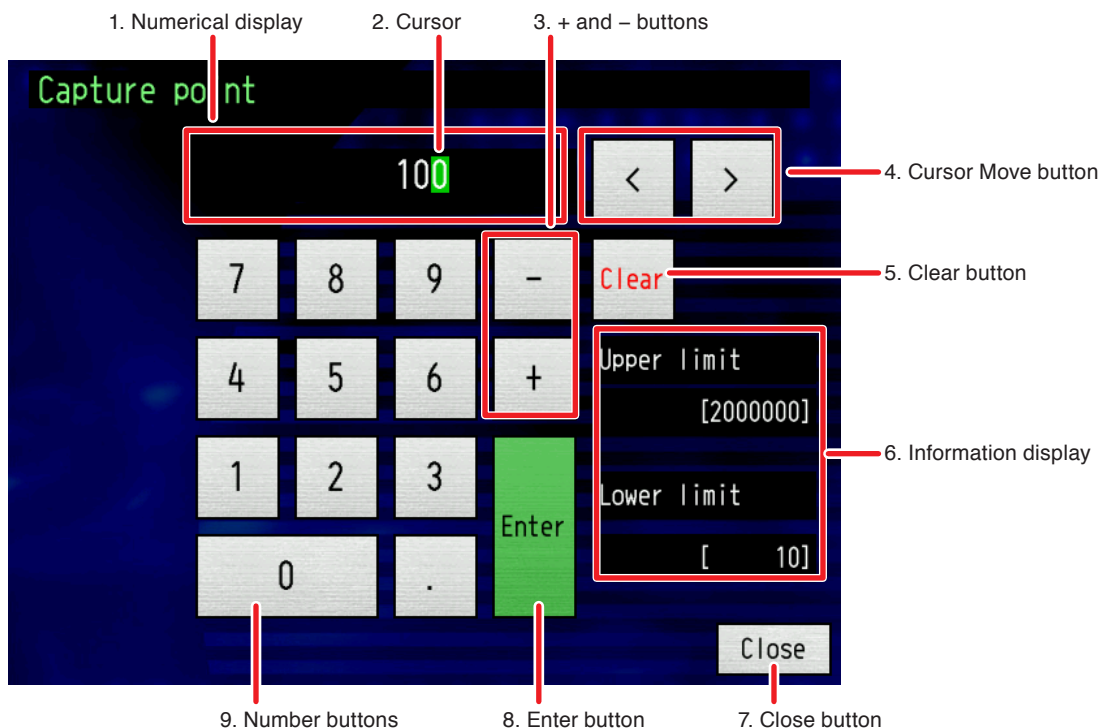

1. Numerical display

The entered values are displayed.

2. Cursor

The green square box is the cursor for displaying the position for input.

3. + and - buttons

Used when changing the plus/minus sign of the numerical value.

4. Cursor Move button

The cursor can be moved left and right. With this button, the cursor can be moved to the position you want to correct, and pressing the numeric button the input will change.

5. Clear button

Entered value is cleared to zero.

6. Information display

Information such as upper and lower limit values are displayed.

7. Close button

This screen is closed, returning to the previous screen. Entered values are cleared.

8. Enter button

Entered values are confirmed, returning to the previous screen.

9. Number buttons

This button is used to enter the values with the cursor.

<EX. 1> : Enter 123.

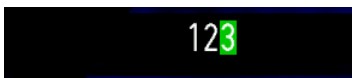

Press the 1, 2 and 3 keys in order.
Press ENTER key at the end.

CHECKPOINT

When an entered value exceeds the upper or lower limit value, the message below will be displayed. Once this message is closed by pressing close once, please set a value that lies between the upper and lower limit values.

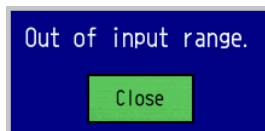

<EX. 2>: Change 2000 into 2500.



Press the button twice.



Press the 5 key.
Press ENTER key at the end.
The Number button is closed, and it will return to the settings screen.

(2) Enter a character

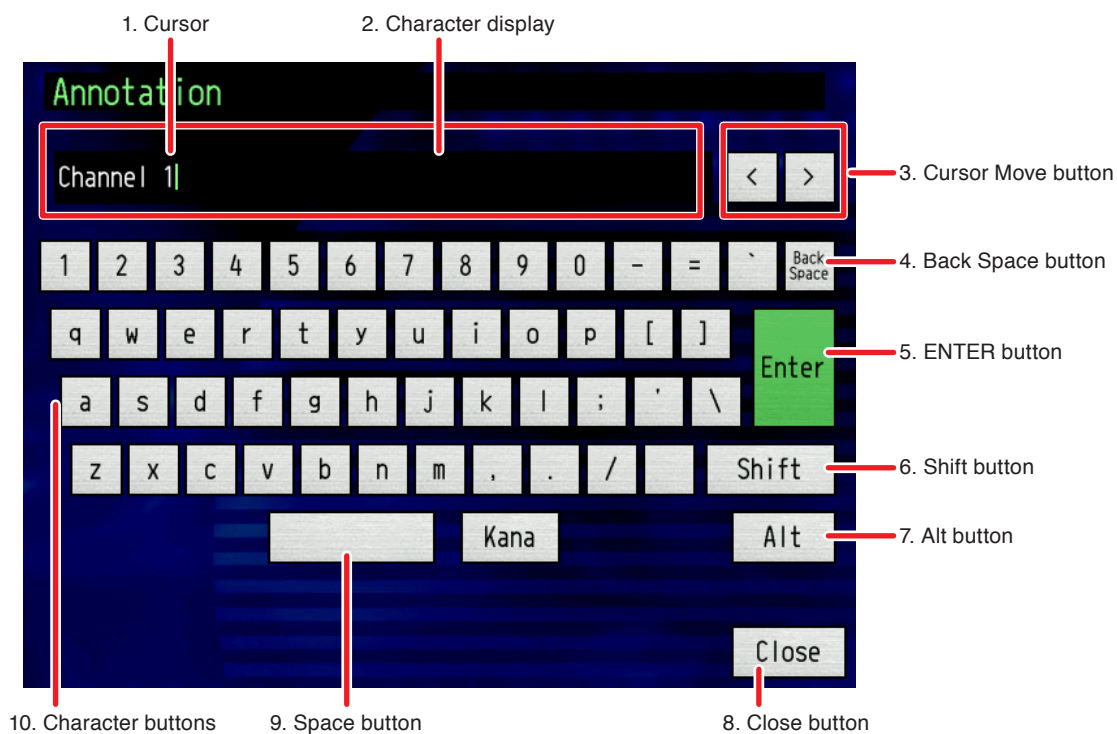

1. Cursor

The green vertical line is the cursor, it displays the input position.

2. Character display

Characters are displayed in this box during entering.

3. Cursor Move button

The cursor can be moved left and right. Moving the cursor with this button and pressing a character button, the character is inserted in that position.

4. Back Space button

This button is used to delete one character to the left of the cursor.

5. ENTER button

Entered characters are confirmed, returning to the previous screen.

6. Shift button

Changes the keyboard. If it is set to "alphanumerical", changes between upper-case and lower-case letters.

7. Alt button

When in "kana character" mode, this changes the layout between "JIS keyboard layout" (general computer keyboard kana character sequence) and a syllable-based arrangement keyboard.



<JIS keyboard layout>

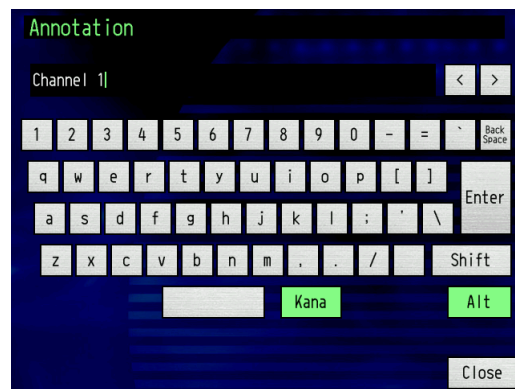

<Alphabetical order>

8. Close button

Closes the current screen and returns to the previous screen. Any entered characters are cleared.

9. Space button

Inputs a space. From the cursor, if there is a character to the right, it's shifted to the right.

10. Character keys

Enters a character to the left side of the cursor. From the cursor, if there is a character to the right, it's shifted to the right.

11. Character key

Enter the characters to the left of the cursor. If there are the characters to the right, shift to the right with the cursor.

(3) File operations

This explains, specifying file names and copying operations for each menu and settings.

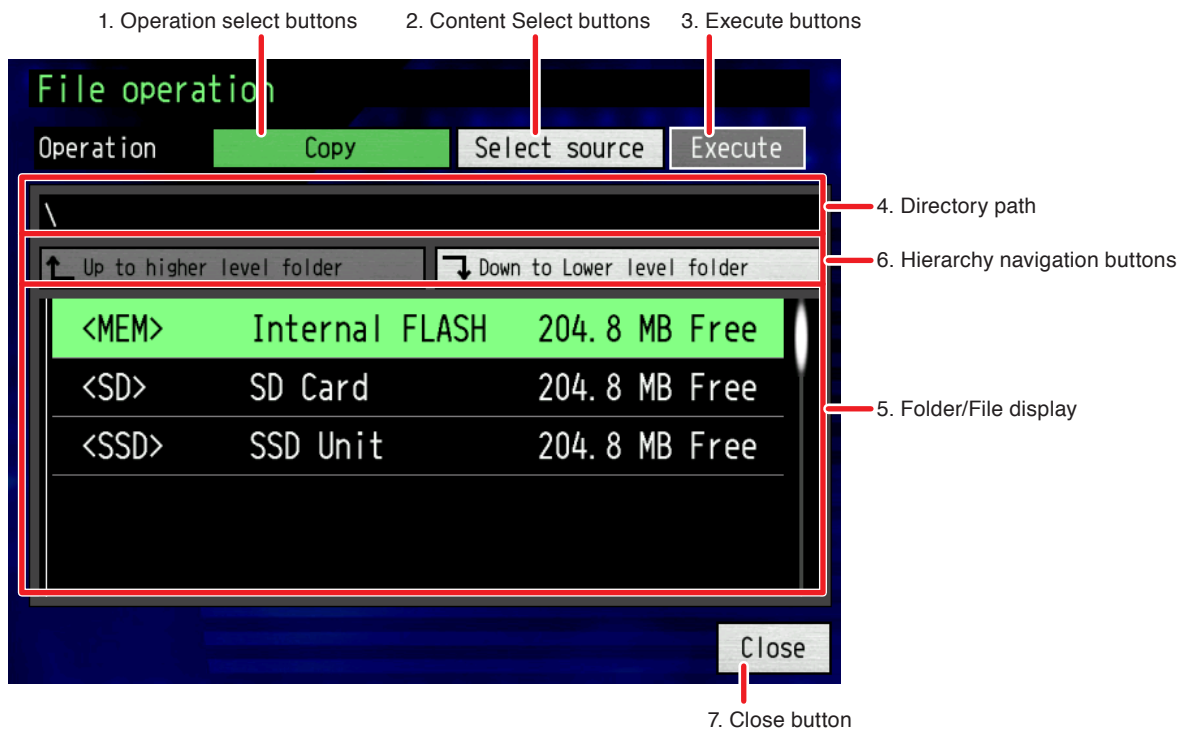

1. Operation Select buttons

These buttons are used select operations.

| Item Select | Description |
|-------------------|---|
| Property | Details for the files and folders are indicated. |
| Select | Selects a file or folder to write data to. |
| Cerate new file | Creates a new file. |
| Create new folder | Creates a new folder. |
| Rename | Changes a file or folder's name. |
| Copy | Copies a file or folder. |
| Delete | Deletes the file or folder. |
| Sort | Changes the display order for files and folders. |
| View | Changes the contents displayed for a file and folder. |
| Format | Initializes the disk. |

2. Content Select buttons

This button may be displayed depending on the selected content.

| Selection button | Item select | Description |
|------------------|--------------------|--|
| Copy | Select source | Selects a copy source. |
| | Select destination | Selects a copy destination. |
| Sort | Alphabetical | Files/folders are displayed in name order. |
| | Rvse alpha | Files/folders are displayed in reverse name order. |
| | Oldest first | Files/folders are displayed in order of how old they are. |
| | Newest first | Files/folders are displayed in order of how new they are. |
| View | With size | Displays the file name with file size. |
| | With date | Displays the file name with the last updated date and time |
| | Filename only | Displays the file name only. |
| Format | Quick | Pressing the Execute button performs a quick format. |
| | Normal | Pressing the Execute button performs a normal format. |

3. Execute buttons

Pressing these buttons perform specific operations.

| Item select | Description |
|--------------------|--|
| Property | Displays the information about the drive, folder and file <Drive> Displays the drive name, the file system, open memory, total memory and volume name. <Folder> Displays folder name, creation date, and time of creation. <Data File> Displays the model name, the sample interval, the data points and trigger time. |
| Create new file | Creates a file for data recording or a file for setting conditions. Opens the file creation character entry screen and creates a file under the current displayed drive or folder with the name entered. For how to enter characters, see "(2) Enter a character" on page 3-26. |
| Create new folder | Creates a folder. Opens the folder creation character entry screen and creates a folder under the current displayed drive or folder with the name entered. For how to enter characters, see "(2) Enter a character" on page 3-26. |
| Rename | In File operation screen, change the name of the selected file or folder. When this button is touched, already entered name is display. Change this name to new one. For how to enter characters, see "(2) Enter a character" on page 3-26. * The file will have the extension. Do not change the extension. |
| Copy | Copies the selected file/folder to the specified copy destination (drive or folder). Use the pre-select button to select the original and the copy destination. |
| Delete | Deletes the selected files/folders. |
| Format | Formats the selected drive using set contents. Use the pre-select button to select the type of format. |

4. Directory path

The path to the drive, folder or file that is currently active is displayed.

5. Folder/file display

A list of drives, folders and files is displayed.

6. Close button

The current screen is closed, returning to the previous screen.

7. Directory Level buttons

From the currently displayed folder, moves either 1 directory up or 1 directory down.

<Ex. 1>: Create a folder named test in the root of the built-in flash memory.

("Home" → "Machine" → "Data" → "Capture" → (Built-in flash memory as the recording destination) → "Filename")

(1) Touch where <MEM> is displayed in the file name.

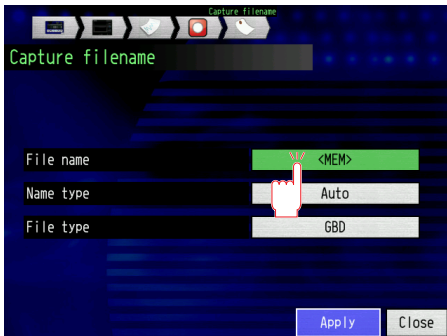

(2) Touch the "<MEM> Internal FLASH".

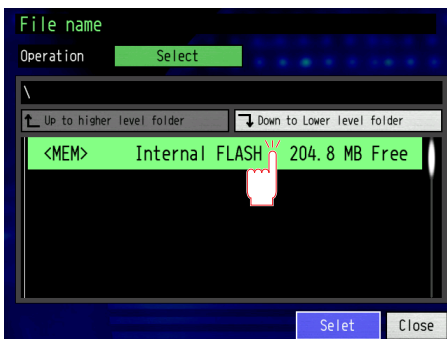

(3) Touch the "Select".

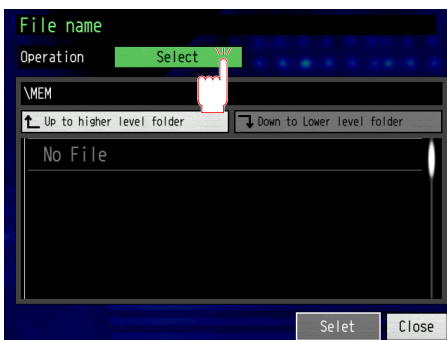

(4) Touch the "Create new folder" twice.

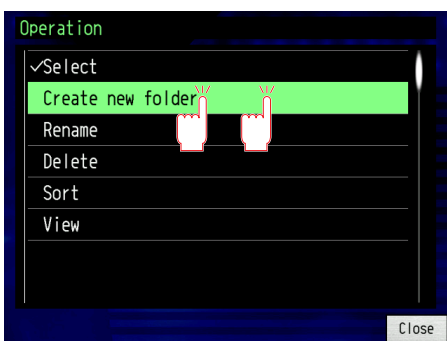

(5) Touch the "Execute"



(6) The keyboard is displayed. Enter "test", and then touch the "Enter".



(7) <test> folder is created.

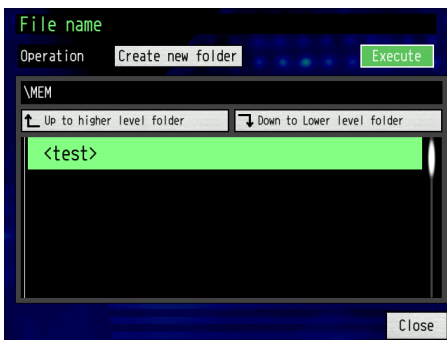

<Ex. 2>: If the automatic naming is used, set as the data is recorded in the Test folder is below the root of the built-in flash memory.

("Home" → "Machine" → "Data" → "Capture" → "Filename")

(1) Touch where <MEM> is displayed in the file name.

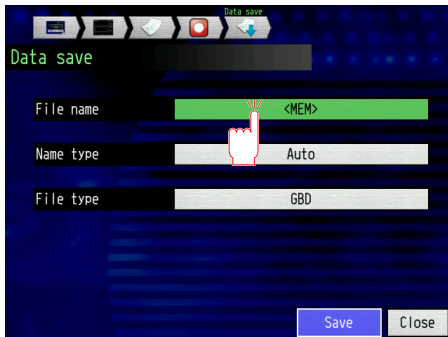

(2) To move to the subdirectory, touch the "<MEM> Internal FLASH".

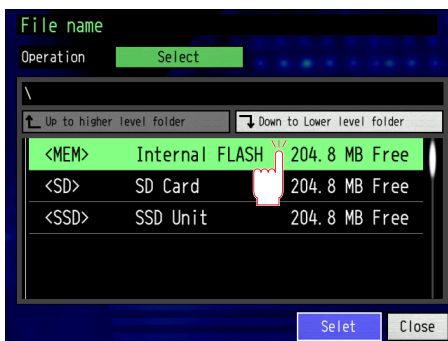

(3) Touch the <Test> folder and then the "Select" button.

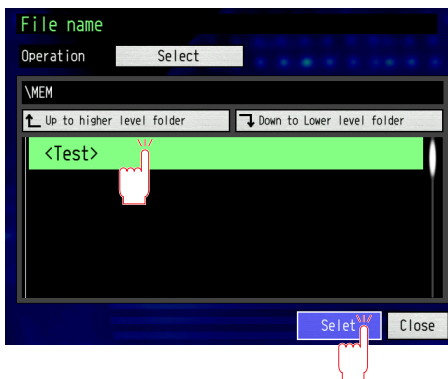

(4) Touch the "Apply". This procedure is complete.

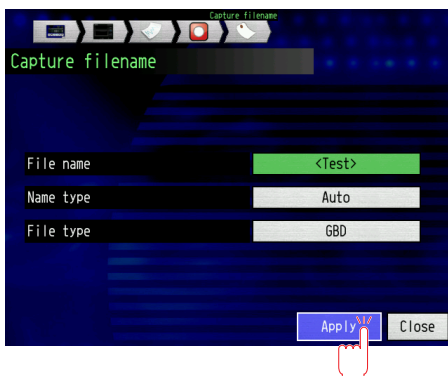

<Ex. 3>: If any naming is used, create the "test.GBD" file in the Test folder is below the root of the built-in flash memory, and then set as the data is recorded in the "test.GBD" file.

("Home" → "Machine" → "Data" → "Capture" → "Filename")

- (1) Touch the "Auto" for the Name type

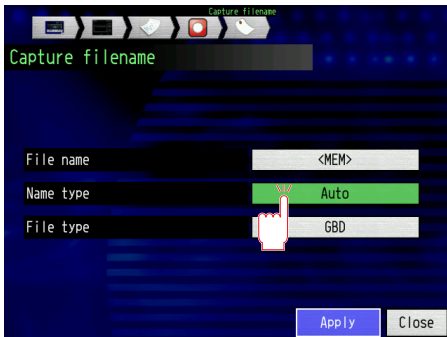

- (2) Touch the "User" twice.

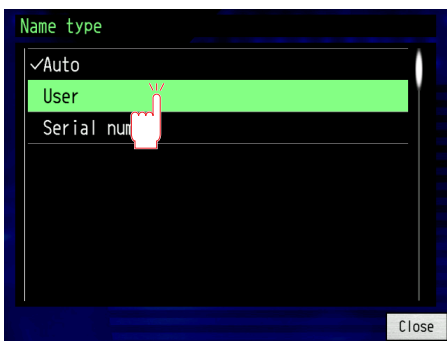

- (3) Touch the "DEFAULT.GBD" for File name

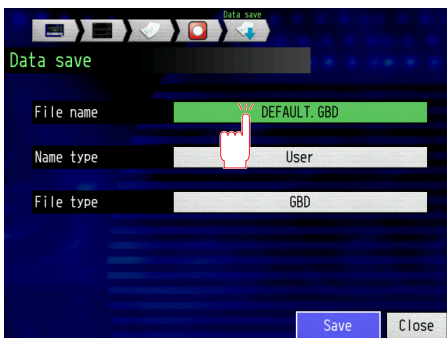

- (4) Touch the "<MEM> Internal FLASH"

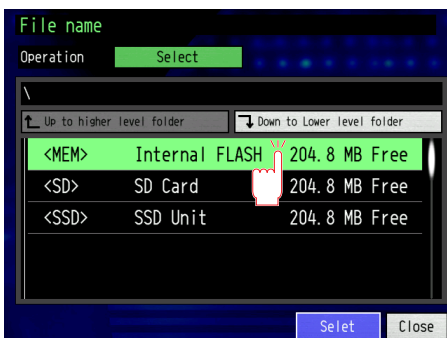

- (5) To move to the subdirectory, touch the <test>.

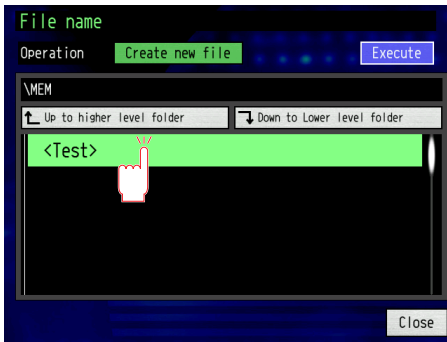

- (6) Touch the "Select".

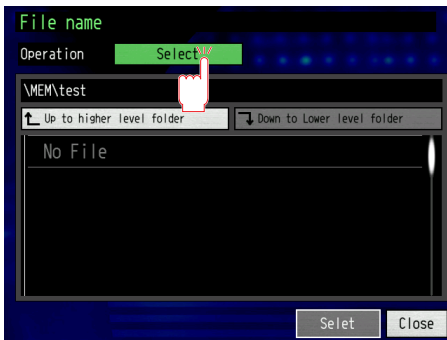

- (7) Touch the "Create new file" twice.

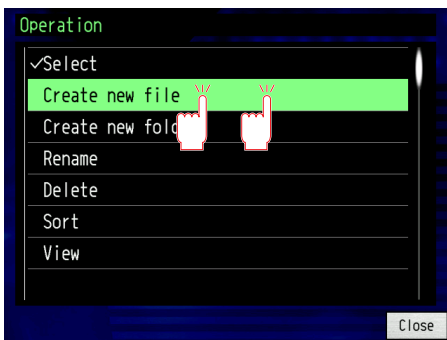

- (8) Touch "Execute"

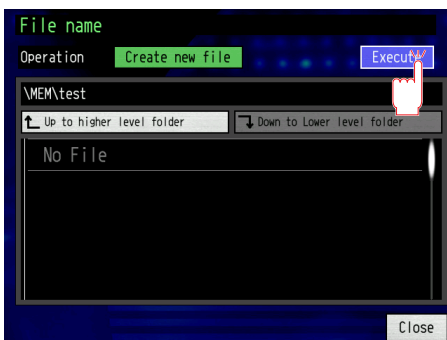

- (9) The keyboard is displayed. Touch the "test", and then touch the "Enter".

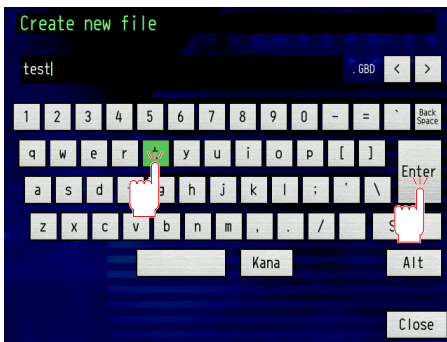

- (10) The file name has been changed to the test.GBD. Touch the "Apply". This procedure is complete.

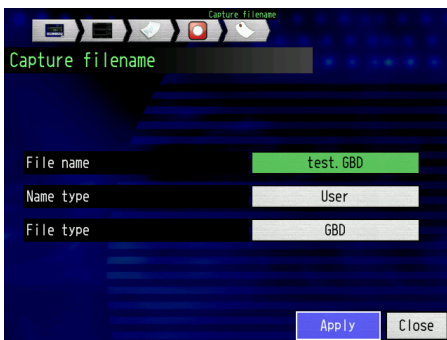

<Ex. 4>: Copies the test.GBD file in the <Test> folder to the Root.

"Home" → "File" → "File operation"

(1) Press the "Property".

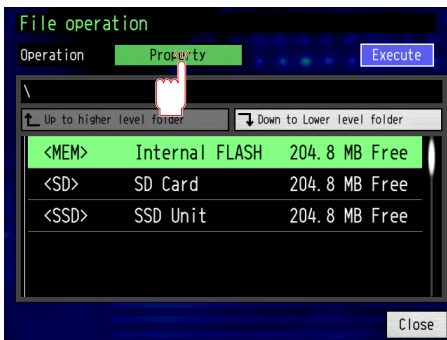

(2) Press "Copy" twice.



(3) Press "Down to Lower level folder" when <MEM> is selected (thus green).

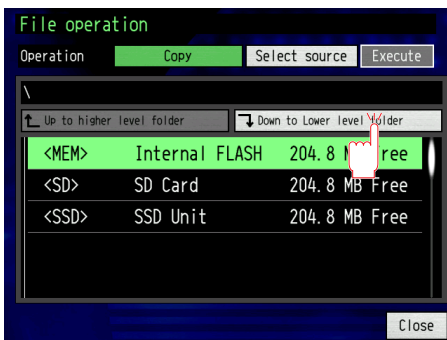

(4) Press "Down to Lower level folder" when <Test> is selected (thus green).

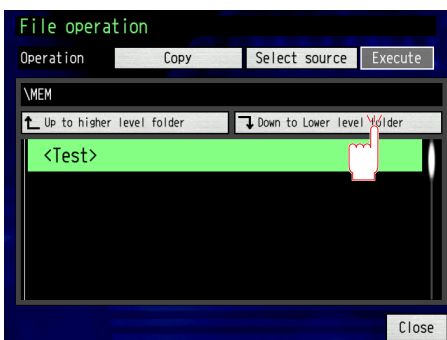

(5) Press and select "test.GBD". (A tick is displayed to the left).

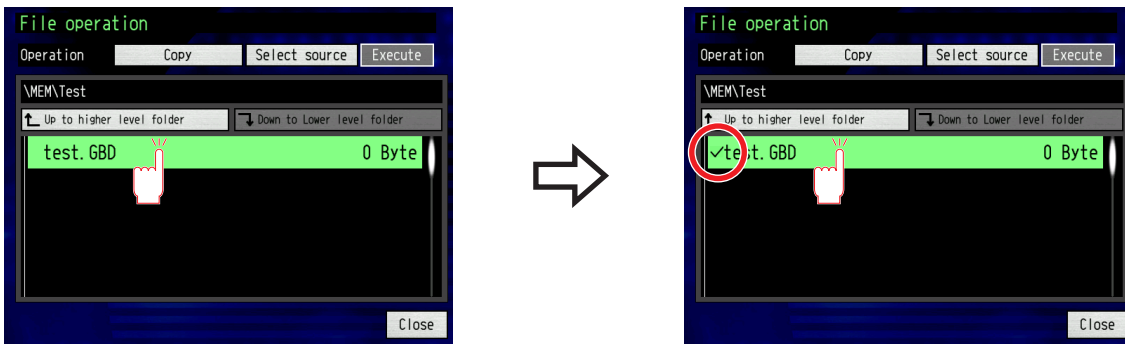

* When copying the multiple files at same time, touch the files to be copied to place a check mark.

(6) Press select "Select source".

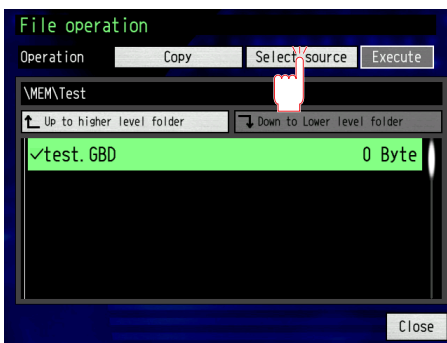

(7) Press select "Select destination" twice.



(8) Select "<MEM> Internal FLASH", and press "Execute".

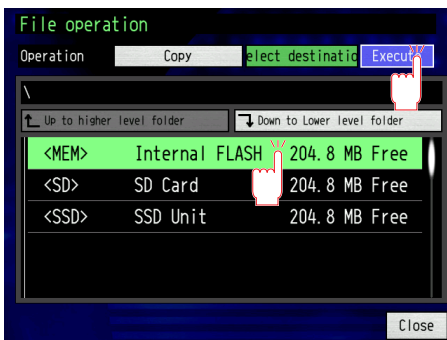

(9) A confirmation message will appear so press "Yes".

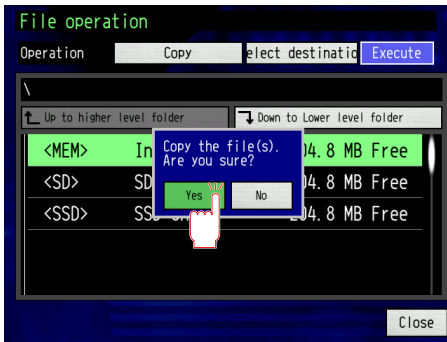

Copy is executed and the operation is completed.

3.4 Key Operations

Here the key functions will be explained.

The GL7000 is fundamentally operated by the touch-panel, but opening menus and some operations can be done with the keys. The Start/Stop function or key lock can only be operated by keys.

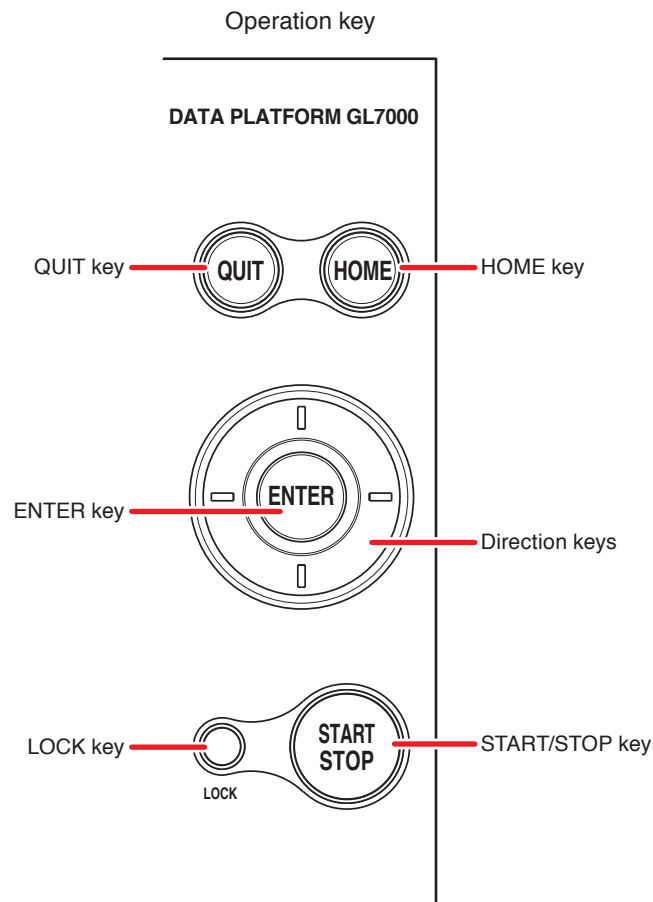

(1) HOME

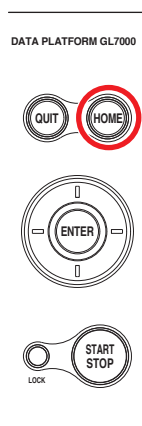

The home menu is displayed when this key is pressed. For details, refer to "(2) Home screen" on page 3-7.

(2) Direction keys

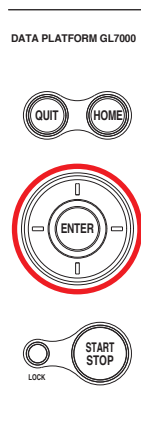

These keys are used mainly for the following operations:

- Cursor movement in MENU settings.
- Cursor movement during replay.
- Analogue CH movement for "waveform + digital screen", "digital + operation screen" (The up and down directional keys)
- Changing the CH to display for "digital + operation screen" (The up and down directional keys)

(3) ENTER

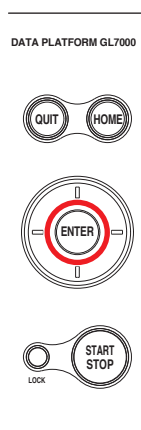

These keys are used for the following operations mainly.

- Confirming set items, opening sub-menus, etc., in the MENU settings.

(4) START/STOP (USB DRIVE)

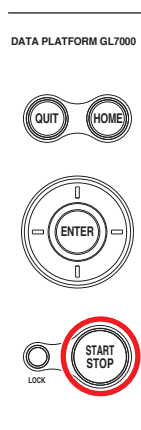

This key performs the following 2 functions:

- During free running, starting a recording.
- During recording, stopping the recording.

Using the USB cable between the GL7000 and computer. By turning on the power while pressing the Start/Stop key, it goes into USB Drive Mode.

For more information on USB Drive Mode, see the next page.

USB Drive Mode

In "USB Drive Mode", you can see the "Built-in flash memory", "SD card", or "SSD" as an external storage device on the computer.

Because it's recognized as a removable drive, file transfer and deletion can be done easily.

<When using the Display module>

- (1) Set the USB Drive Mode target

When "Home" → "Machine" → "I/F, USB settings" is touched, the following is shown.

Select the drive to connect to the PC as USB Drive Mode.

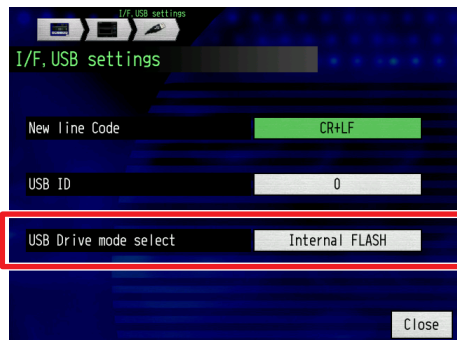

- (2) Turn off the power once. Using the USB cable, connect between the GL7000 and computer.
- (3) Turn on the power while holding down the "START/STOP" key on the GL7000.
- (4) An external storage medium will be recognized by the PC and data may be transferred.

* While in "USB Drive Mode", the GL7000 will show the following:

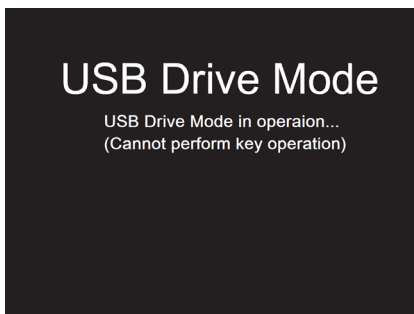

<When Display Module is not used>

When the Display Module is not used, USB Drive Mode can be used by following the procedures below.

- (1) Set the USB Drive Mode target.

Use GL Config for settings.

Please see the GL-Connection manual for details.

- (2) Please connect the GL7000 to the PC with a USB cable.

- (3) Make sure that the power switch is turned off. Remove the face cover, and then slide the slide switch to ON position.

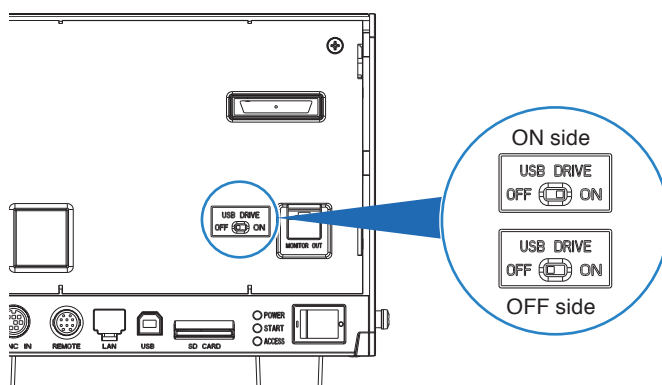

- (4) Turn on the machine. When powered up, external memory will be recognized on the PC allowing file exchange.

⚠ CAUTION

- When clearing the USB Drive Mode, turn off the power once, slide the switch on the side to "OFF", and turn the power back on.
- When using the USB Drive Mode, all operations, such as data recording and data replay, temporarily stop functioning.
- When using the USB Drive Mode, the USB driver must be installed on the PC. The "USB driver" and "USB driver installation instructions" are stored on the attached CD. Please install according to the instructions.
Location of Instructions:
D:\USB Driver\Japanese\GL-USB-UM15X.pdf (D:\ is the drive where the CD is inserted. It changes depending on the computer.)

(5) LOCK

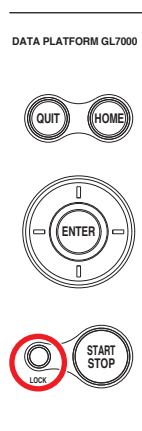

Pressing this key for 2 seconds or more lets you set or clear the key-lock. A password can also be set to clear the key-lock. For details, see the "Set and clear the key-lock with the password" on page 3-43.

(6) QUIT (LOCAL)

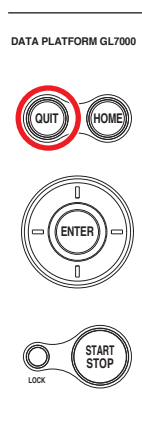

These keys are primarily used for the following functions:

- In the MENU settings, cancels the settings selections.
- Clears the remote status (where the keys are not functioning) depending on the interface arrangement.
- Closes the MENU screen.
- Ends data replay.
- For the Alarm settings, when "Alarm hold" is set to On, the retained alarms are cleared.

CHECKPOINT

- Pressing the QUIT key on the screen that icons and buttons are displayed will close all menus and open the waveform display.
- Pressing the QUIT key on the screen that setting values are selected will return to the previous screen.

Set and clear the key-lock with the password

A password can be set to clear the key-lock (Password is not set by default.).

< Operation >

- (1) Set a password.
Simultaneously pressing "ENTER" and "LOCK" keys displays the following password setting screen.
Enter a four-digit password.

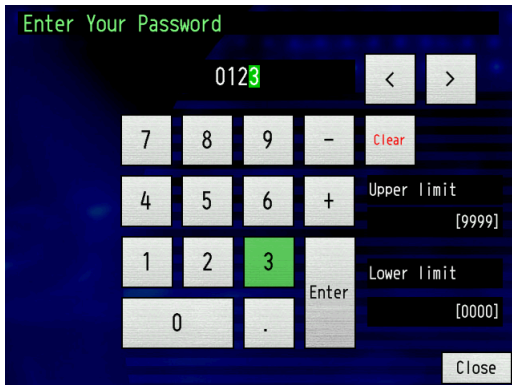

By touching the Enter key at the end, the password is confirmed.

For the "0000", it is operated without a password.

If you forget your password, please call our Customer Care Center and ask for a master password.

- (2) Set the key-lock.
Touch the LOCK key for 2 seconds or more.
- (3) Clear key-lock.
Touch the LOCK key for 2 seconds or more.
The following password setting screen is displayed. Enter the password.

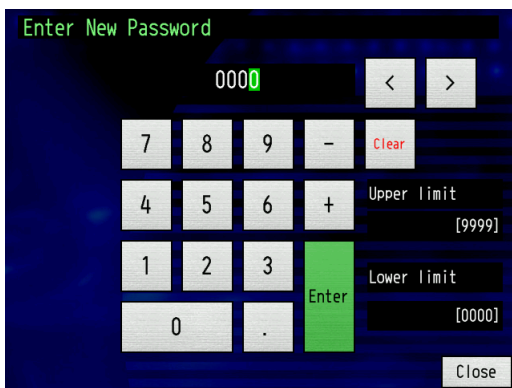

If the password is wrong, key-lock cannot be cleared.
Key-lock is maintained even if the power is turned off.

3.5 Description of Each Operating Mode

Each operation status can be checked with the "Simple message display".

| Action | Action name | Simple message display |
|--------------------|---|--|
| Free running | When neither being launched nor when a recording is performed. | Free running |
| Recording | Data is being recorded to the various storage device devices. | RAM recording, Memory recording, SD card recording, SSD recording. |
| 2 screen replaying | Playback of the current waveform display and data during recording. | Memory recording, SD card recording, SSD recording. |
| Replaying | Replaying already recorded data. | Replaying RAM, Memory Review, Replaying SD card, Replaying SSD. |

<Action status transition diagram>

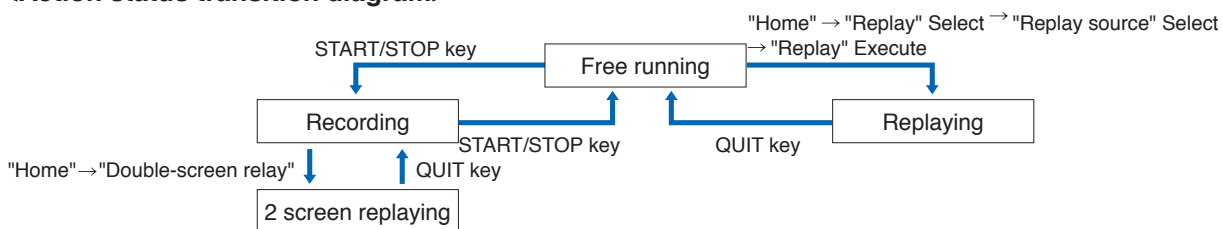

CHECKPOINT

- For recording with the built-in RAM, the "Double-screen" cannot be selected.
- When the sample interval is less than 100 ms, "Double-screen replay" is not available.
- When the recording format is "CSV", "Double-screen replay" is not available.
- When the sampling interval used in recording with the built-in RAM is 500 μs or less, the recording stops, and then it is automatically replayed.

(1) Free running

During free running, mainly settings for recording are being carried out. The current input signal can be accessed as a waveform or a digital value.

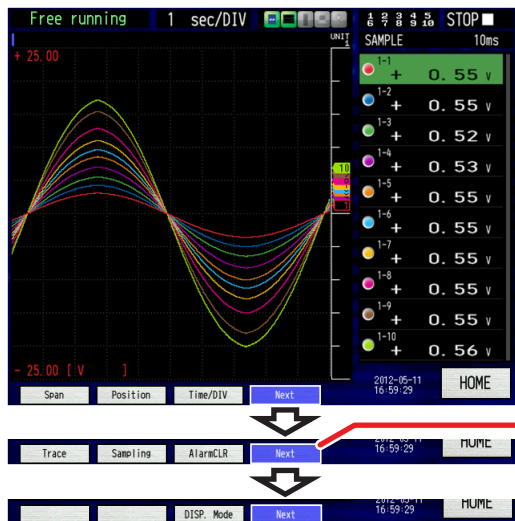

Each time you touch the "Next", the function of the Function button is changed. The Function button allows you to modify the time scale, to process the waveform, to set the sampling, to clear the alarm, and to change the display mode.

Possible main actions during free running

| | |
|--|---|
| Changing the measurement conditions settings | Various measuring conditions can be set (See page 3-48). |
| Waveform control | The waveform position can be moved, and zoomed in or out (See page 3-112). |
| Change the display mode | Y-T, Y-T (all screens), logger, XY, FFT displays can be switched. (See page 3-114). |
| Clearing the alarm | If an alarm is set, it may be cleared. (See page 3-5). |
| File operations | Various file operations can be performed (See page 3-28). |
| Data replay | Recorded data can be replayed (See page 3-129). |
| Changing the timescale | Changes timescale on the time axis (See page 3-112). |

(2) Recording

During recording, data is recorded to the built-in RAM, the built-in flash memory, the SD card, or SSD. Recording settings can not be changed.

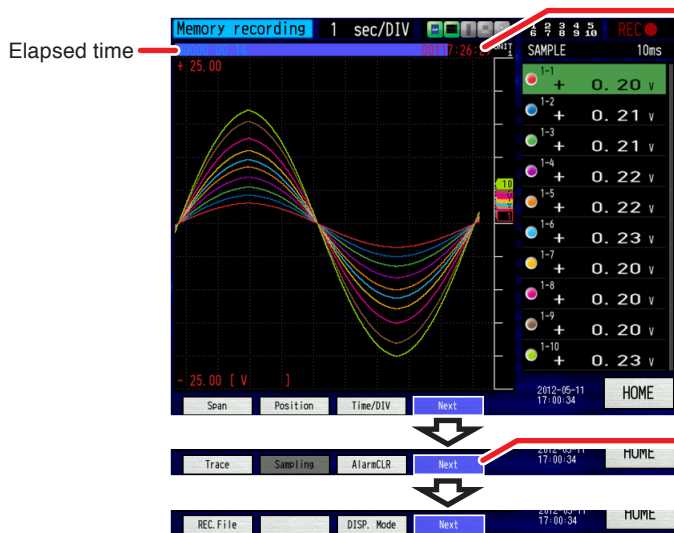

Remaining capacity of the recording destination memory (If available recording time exceeds 99999 hours, "++++:++++" is displayed.)

Each time you touch the "Next", the function of the Function button is changed. The Function button allows you to modify the time scale, to process the waveform, to clear the alarm, to change the display mode, and to confirm the recorded file name.

Possible main actions during recording

| | |
|-----------------------|--|
| Confirm Settings | The recording settings can be viewed. |
| Waveform Operations | Waveform position can be moved or zoomed in or out (See page 3-112). |
| Change display mode | Y-T, Y-T (all screens), logger, XY displays can be switched (See page 3-114). |
| Clearing the Alarm | If an alarm is set, it can be cleared (See page 3-5). |
| 2 Screen Replay | The waveform of the file being recorded can be compared with a waveform recorded in the past using two screens. 2 Screen Replay may not be useable depending on the sampling rate, recorded target and settings. Please see p3-46 "2 Screen Replay for details". |
| Changing the timescal | The timescale on the time axis can be changed (See page 3-113). |

(3) 2 screen replaying

The current waveform being recorded and a waveform recorded in the past can be compared using double-screen.

The double-screen replay can be used if the sampling interval is 100 ms or more and the recorded file is in the "built in flash memory", "SD card" or "SSD".

The double-screen display can be changed by pressing "Home" > "double-screen replay" while recording.

The waveform display on the right side is the currently recording data, while already recorded data is displayed on the left. For the already recorded data, by moving the cursor with the direction keys (<|>) or by dragging on the screen, it is possible to check the digital value.

To return single-screen, touch the "Quit".

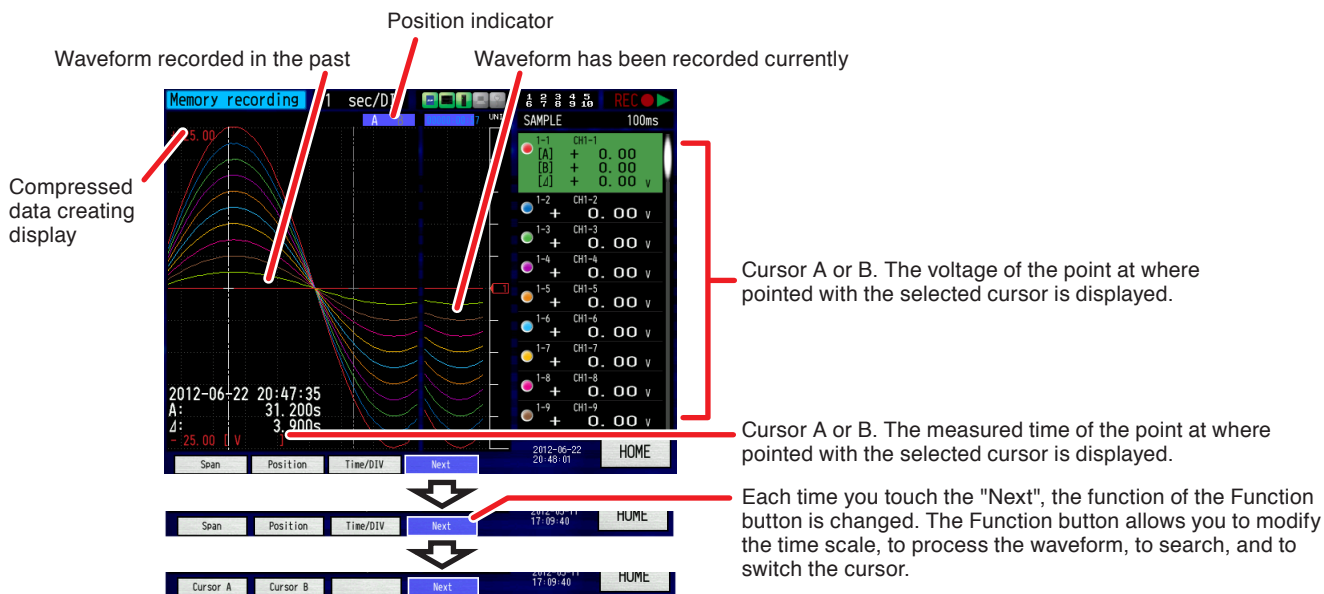

Possible main actions during 2 screen replay

| | |
|--------------------------|--|
| Confirm Settings | The recording settings can be viewed. |
| Waveform Operations | Waveform position can be moved or zoomed in or out (See page 3-112). |
| Changing the timescale | The timescale on the time axis can be changed (See page 3-112). |
| Moving the Cursor | The cursor can be moved to a designated place (See page 3-137). When the left edge of the position indicator touched, "Move to first", and when the right edge of the position indicator touched, "Move to last". |
| Copy screen (Screenshot) | The current waveform displayed is saved with a BMP or PNG format (See page 3-136). |
| Data save | All the data or the data between cursors can be saved during replaying on the double-screen. |

CHECKPOINT

- When replaying with the double-screen, the historical data is displayed with thinning temporarily. In this case, a red line is displayed while creating compressed data. (As soon as the compressed data is created, it is displayed.)
- When the recording format is "CSV", "Double-screen replay" is not available.

To save the data during replaying on the double-screen

The recording data can be saved during replaying on the double-screen.

When selecting "HOME" → "File" → "Data save" during replaying on the double-screen, the Data save screen is displayed. The data is saved by touching "Save" after entering the file name, naming method, file format, and saving range.

For more information about the data save, see "(18) Data save" on page 3-130.

(4) Replaying

Displays the recorded data.

By pressing "Home" → "Replay" and selecting a data, the data can be replayed.

(Please see p3-121 "(15) Replay setting screen (Data relaying screen)")

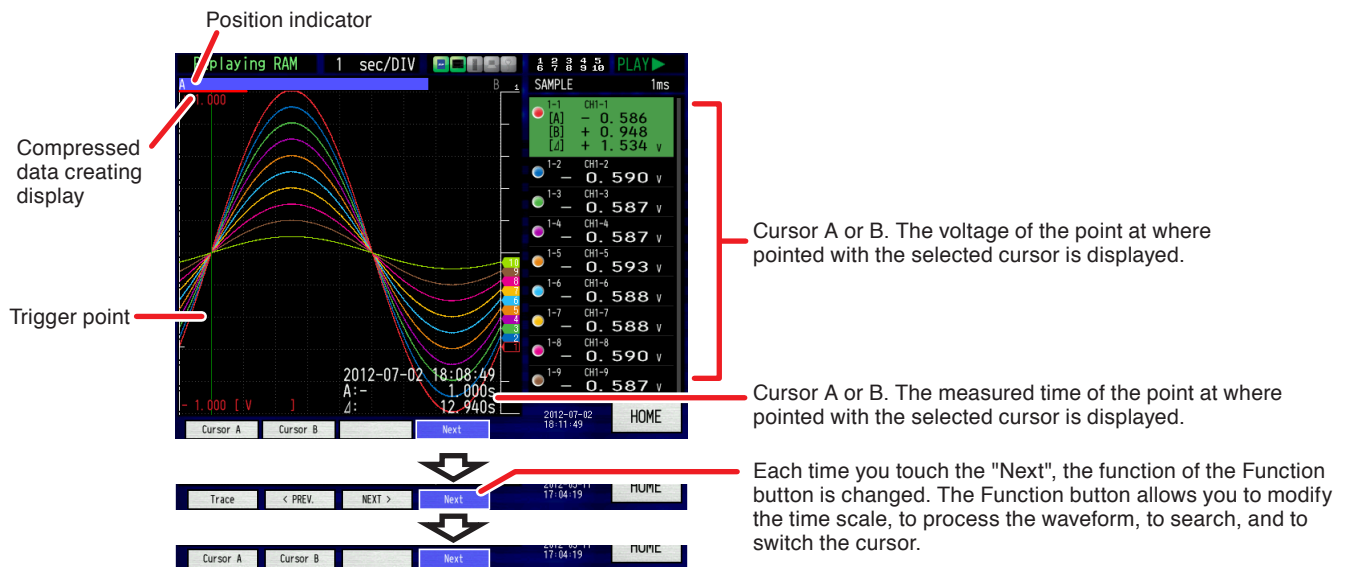

Possible main actions during replay

| | |
|-----------------------------------|--|
| Setting the measurement condition | Measurement conditions can be set. |
| Waveform operations | The waveform positions can be moved or zoomed in or out (See page 3-112). |
| Moving the cursor | The cursor can be moved to a designated place (See page 3-137). When the left edge of the position indicator touched, "Move to first", and when the right edge of the position indicator touched, "Move to last". |
| Search | By setting the requirements, data passing the requirements can be searched (See page 3-139). |
| File operations | File operations can be done (See page 3-28). |
| Save Data | The entire data or data with certain set parameters can be saved (See page 3-130). |
| Replay data | Data recorded can be replayed (See page 3-112). |
| Changing the timescale | The timescale on the time axis can be changed (See page 3-112). |
| Copy Screen (Screenshot) | The current waveform displayed as a BMP or PNG format can be saved (See page 3-136). |
| Statistical Calculation | Average value, peak value, maximum value, and minimum value for the data during replaying are displayed (see page 3-142). |

CHECKPOINT

- When replaying with the double-screen, the historical data is displayed with thinning temporarily. In this case, a red line is displayed while creating compressed data. (As soon as the compressed data is created, it is displayed.)
- When the sampling interval used in recording with the built-in RAM is 500 μ s or less, the recording stops, and then it is automatically replayed.

3.6 Explanation of the Settings Menu

Pressing the "Home" button on the screen or the "Home" key displays the home screen, By pressing each icon button, each settings menu can be selected.

(1) Record settings

Changes settings mainly related to recording.
 ("Home" → "Machine" → "Data" → "Capture")

<When the recording destination is the built-in RAM>

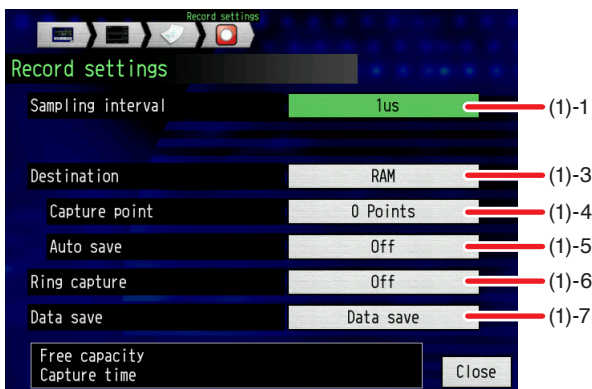

<When the recording destination is something other than the built-in RAM>

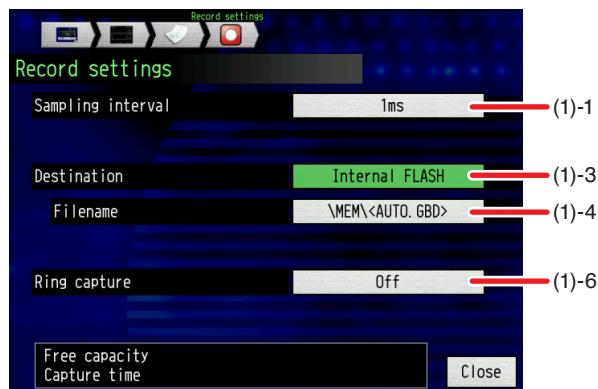

<When the sampling interval is external>

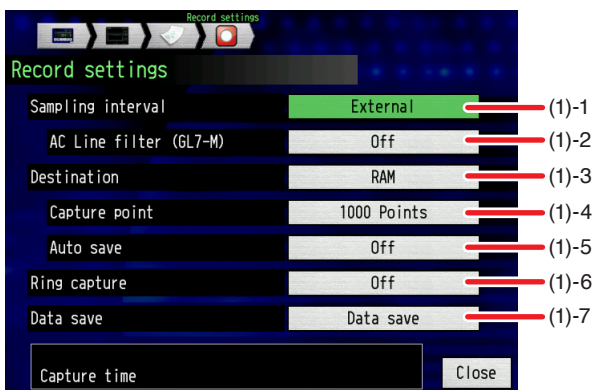

| Item select | | Examples of item |
|-------------|---|--|
| (1)-1 | Sampling interval | 1/2/5/10/20/50/100/200/500us, 1/2/5/10/20/50/100/125/200/250/500ms, 1/2/5/10/20/30s, 1/2/5/10/20/30min, 1h, External |
| (1)-2 | [External] AC Line filter | Off, On |
| (1)-3 | Destination | RAM, Internal FLASH, SD Card, SSD Module |
| (1)-4 | [RAM] Capture point | 1 to 2,000,000 (Numerical entry) |
| (1)-5 | Auto save | Off, On |
| (1)-6 | Ring capture | Off, On |
| | Data points | 1 to 2,000,000 (Numerical entry) |
| (1)-7 | [Internal FLASH] [SD Card] [SSD Module] | Data save * Please refer to the file name of the saved data. |

(1)-1 Sample interval

Sets the data recording interval.

The fastest sample interval that can be set is limited by the following items. If a sample interval that cannot be recorded is set, the color changes and this mark is displayed. ( 1us)

If the sample interval displays this mark, please change the recording destination when going to record.

<Things affecting sampling rate>

- Recording destination
- Connected amplifier types
- Number of connected amplifiers (When the recording destination is the SSD)
- File format

Recording destination, file format, and sample interval

| Recording destination | | File format | Sample interval*1 | |
|-----------------------|-----------------|--------------|----------------------|----|
| RAM | | – | 1us to 1h, External | |
| Internal FLASH | | GBD (Binary) | 1ms to 1h, External | |
| | | CSV (Text) | 10ms to 1h, External | |
| SD Card | | GBD (Binary) | 1ms to 1h, External | |
| | | CSV (Text) | 10ms to 1h, External | |
| SSD Module*4 | 1 to 2 modules | GBD (Binary) | 1us to 1h, External | *2 |
| | 3 to 4 modules | | 2us to 1h, External | *3 |
| | 5 to 10 modules | | 5us to 1h, External | |
| | 1 to 10 modules | CSV (Text) | 10ms to 1h, External | |

- *1: The fastest sample interval changes depending on the connected amplifier module type. The possible recording sample interval varies for each connected Amplifier Module. When combining different types of Amplifier modules, the sample interval of the fastest Amplifier Module can be set, but the slow Amplifier module continues with the same data until data changed at the fastest sampling interval it can manage.

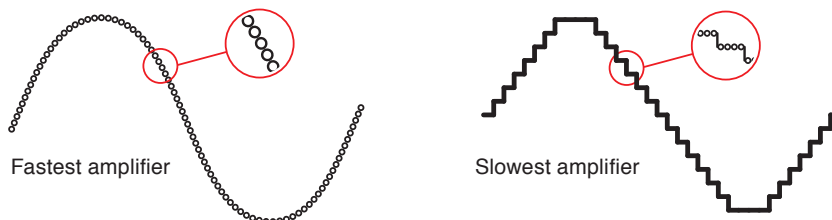

- *2: When a Logic/Pulse module is connected and a pulse selected, 8ch(CH1~CH8) can be recorded at 1 μ . However, the maximum sampling rate of the pulse is 100 μ s, so the data is updated only every 100 μ s.)
- *3: When a Logic/Pulse module is connected and a pulse selected, 16ch can be recorded over 2 μ . When two modules are connected, and a pulse selected, each module can record data to 8ch(CH1~CH8). (However, the maximum sampling rate of the pulse is 100 μ s, so the data is updated only every 100 μ s.)

< Ex. 1> Sampling 1 μ



The pulses of CH1 to CH8 are recorded.

< Ex. 2> Sampling 2 μ



The pulses of CH1 to CH8 in each module are recorded.

< Ex.3> Sampling 2 μ

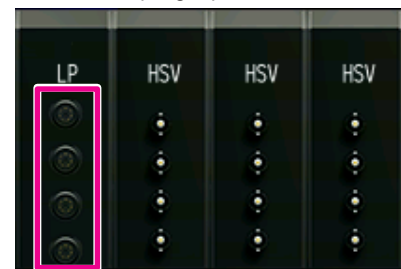

The pulses of CH1 to CH16 are recorded.

- *4: Depending on the state of fragmentation of the SSD, there may be cases where the sampling rate won't be written on time (A message will be displayed during recording). If this sort of event occurs, please backup important data to another media and format the SSD.

External Sampling

When the external sample interval is set, the data is captured and retained once with the internal sample interval.

This retained data is updated with the external sample interval.

The data to be recorded is written in the recording destination each time the external sampling pulse is received (See the figure below).

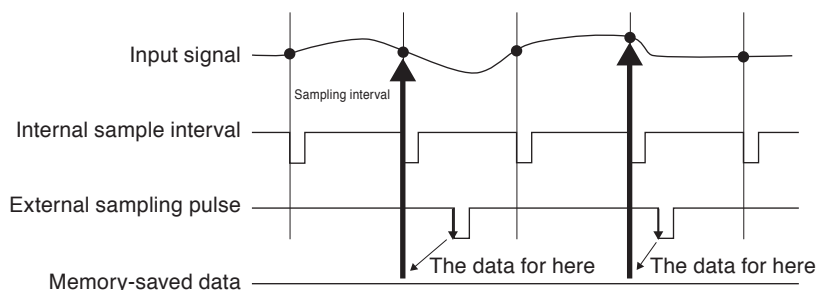

CHECKPOINT

If the external sampling pulse has entered two or more times faster than the internal sample interval, the second and subsequent times are ignored. Set the external sampling to longer interval than the internal sample interval.

The internal sample interval is as follows.

| Recording destination | High Speed Voltage/High Voltage module | Voltage module | Voltage/Temperature module | Logic/Pulse module |
|-----------------------|--|----------------|-----------------------------|-----------------------------------|
| RAM | 1 μ s | 1ms | See "(1)-2 AC line filter". | Logic 1 μ s/Pulse 100 μ s |
| Internal FLASH | 1 ms | 1ms | See "(1)-2 AC line filter" | 1 ms. |
| SD Card | 1 ms | 1 ms | See "(1)-2 AC line filter" | 1 ms |
| SSD Module | 1 ms | 1 ms | See "(1)-2 AC line filter" | 1 ms |

(1)-2 AC Line filter

This is set for an option module GL7-M only.

Set the AC line filter to On/Off when the sampling interval is set to external.

When set to On, the digital filter of the Voltage/Temperature amplifier is enabled. When measuring a signal with lots of noise and using external sampling, please set the AC Line filter to On.

The fastest interval is 1 second.

OFF : The Internal sample interval is 10 ms.

ON : The Internal sample interval is 1 s.

For the internal sample (interval), see the descriptions of the "External Sampling" above.

(1)-3 Destination

Selects the recording destination. Each recording destination has its advantages.

RAM : Recording can be done at the fastest sample interval. The maximum number of recording points is 2,000,000.

The fastest sample interval changes for the types of modules, but even if the number of modules is increased, the maximum number of recording points does not change. Data is deleted if the power is turned off or the next recording is performed. Recording in CSV format is not possible.

Internal FLASH : The sample interval starts at 1ms (10ms in the case of CSV format).

It remains even if the power is turned off. Direct access from a PC is possible if the built-in flash memory is opened in USB Drive Mode.

- SD Card : Recording can be done when an SD card is inserted into the SD slot. The sample interval starts at 1ms (10ms in the case of CSV format).
Data remains even if the power is turned off. By taking out the SD card, it can be directly seen on a PC.
- SSD Module : This is an optional module. It's suitable for high speed, large capacity recording. The fastest sample interval changes depending on the number of connected modules (refer to "(1)-1 Sample interval" on page 3-49).
In the case of CSV format it starts from 10ms. Data remains even if the power is turned off.

CHECKPOINT

- When the built-in RAM is selected as recording destination, by setting the auto-save function to ON (refer to (1)-5 Auto-save on page 3-52), recorded data can be saved on nonvolatile memory (built-in flash memory, SD card or expanded SSD).
- As the auto-save takes some time, even after the recording is finished, the writing to the built-in flash memory, SD card or expanded SSD may not be finished. Please do not turn off the power until it's finished.

(1)-4 Capture point

Sets the number of data points when recording to the built-in RAM. This can only be set if built-in RAM was selected to be recorded to.

Enter a number. (For details, see "(1) Numerical entry" on page 3-24.)

("Home" → "Machine" → "Data" → "Capture" → "Capture point")

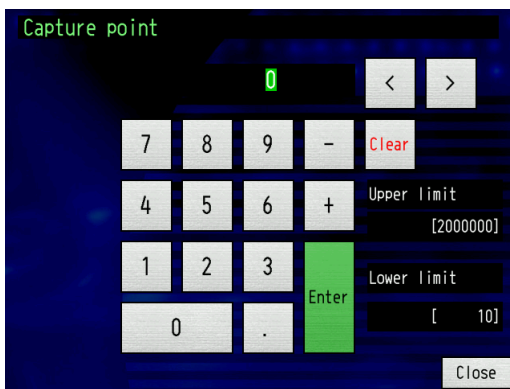

The possible recording time depends on the settings of the sampling interval and the number of recording points. The recording time is displayed in the part A in the figure below.

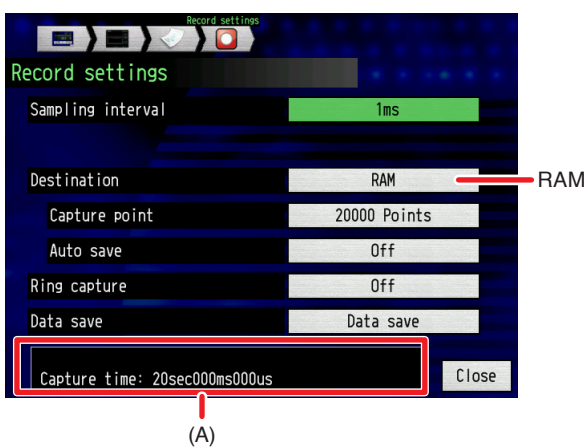

(1)-5 Auto save

Sets the auto-saved function for the built-in RAM. This can only be set when RAM is selected to be recorded to. ("Home" → "Machine" → "Data" → "Capture" → "Auto save")

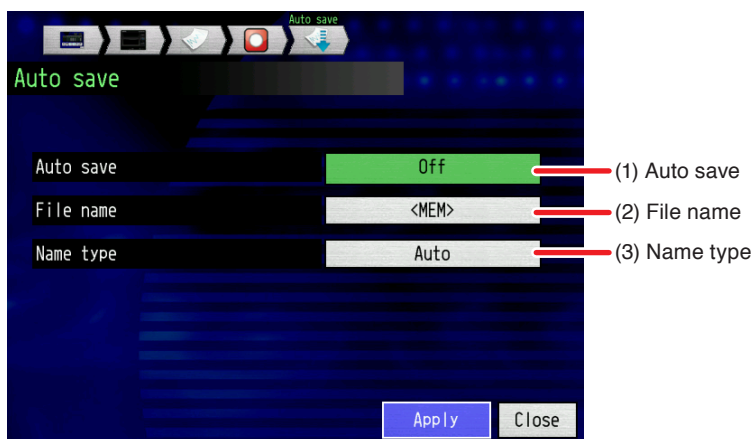

| Item select | | Examples of item |
|-------------|-----------|--|
| (1) | Auto save | Off, On |
| (2) | File name | Recording destination folder name or file name |
| (3) | Name type | Auto, User, Serial number |

(1) Auto save

| Item select | Examples of item |
|-------------|--|
| Off | Auto-save is not activated. Data is deleted if the power is turned off or the next recording is performed. When wanting to save recorded data, please save data after replay (refer to "(18) Data Save" on page 3-130). |
| On | Auto-save is done. Data recorded on the built-in RAM is saved on the built-in flash memory, SD card or the expanded SSD. HINT When speeding up the sample interval or increasing the number of recorded data, even if recording to the built-in RAM has been finished, auto-save may not be finished. At such a time, it is not possible to perform the next recording using the Start/Stop key until the auto-save has finished. |

(2) File name

Specifies the recording destination folder and file name. Refer to "(3) File operations" on page 3-28 on how to set a file.

(3) Naming metho

Sets how data files are named.

Auto : Files are automatically named.

<Ex>: 20120101-123456.GBD

The numeric part The day the file was created

* E.g. 2012-01-01, 12:34:56

GBD..... Data format, GBD (Binary data), CSV (Text format)

User : Data is recorded to a user-input file name.

Serial number : A consecutive number is attached to the optionally input file name to create the file name.

<Ex>: When the file name is "TEST"

First: TEST_SER1.GBD, Second: TEST_SER2.GBD, Third: TEST_SER1.GBD

* If a file with the same name already exists, to avoid overwriting _CP* is attached to the end of the file name where the * represents a number.

<Ex.>: TEST_CP1.GBD

(1)-6 Ring capture

("Home" → "Machine" → "Data" → "Capture" → "Ring capture settings")

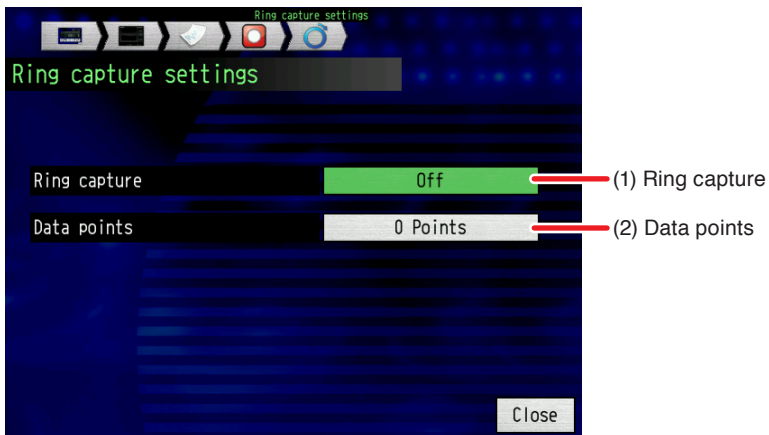

| Item select | | Examples of item |
|-------------|--------------|--------------------|
| (1) | Ring capture | Off, On |
| (2) | Data points | 1,000 to 2,000,000 |

(1) Ring capture

Sets the Ring recording function to On or Off.

(2) Data points

When the ring function is On, the ring point of 1 file is specified.

- Ring capture actions (When the recording destination is the built-in RAM)

If the recording destination is the built-in RAM, the memory is connected in a ring form, and when it exceeds the specified number of the data points, data is deleted starting with the oldest data.

When the main module stops, the data on the number of data set in Number of recording points remain.

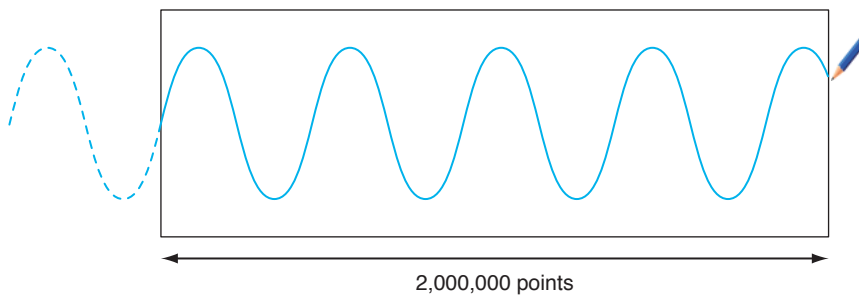

- Ring capture actions (When the recording destination is something other than built-in RAM)
If the recording destination is something other than the built-in RAM, ring capture action is done in the following way.

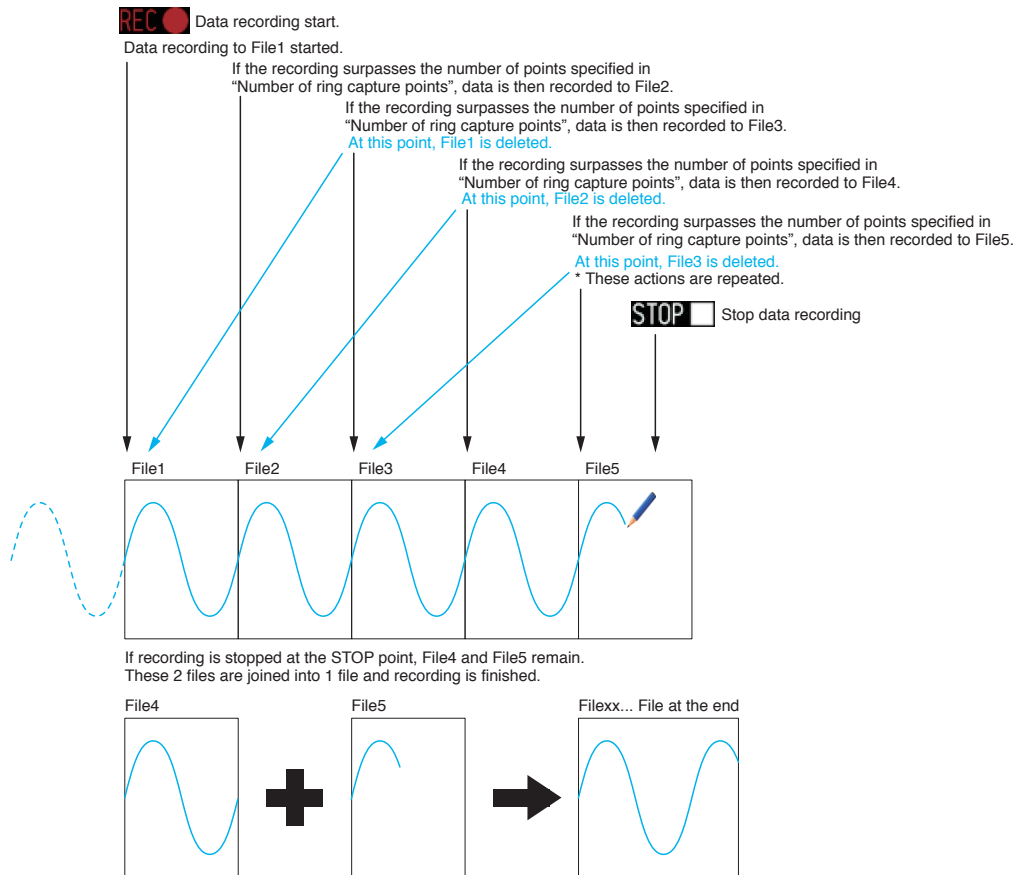

CHECKPOINT

- Up to 2 times the number of ring capture points are possible as files at max.
- The upper limit value of the number of recording points is 1/3 of the free capacity..

(1)-7 Data save

Sets the file name and folder name for the recording destination or the auto-save destination.
("Home" → "Machine" → "Data" → "Capture" → "Data save")

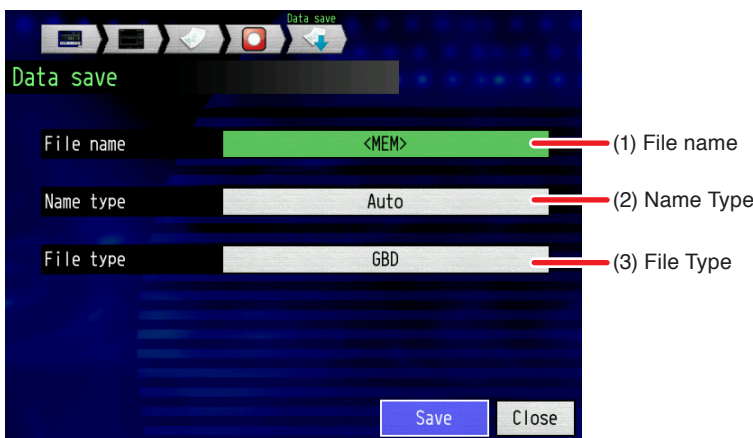

| Item select | | Examples of item |
|-------------|-----------|--|
| (1) | File name | File name or folder name of recording destination. |
| (2) | Name Type | Auto, User, Serial number |
| (3) | File Type | GBD (Binary), CSV (Text) |

(1) File name

Specifies the folder and file name of the recording destination. Refer to "(3) File operations" on page 3-28 on how to set a file.

(2) Name Type

Sets how the data file name is attached.

Auto : Files are automatically named.

<Ex.>: 20120101-123456.GB

The numeric part..... The day the file was created

* E.g. 2012-01-01, 12:34:56

GBD Data format

GBD (Binary data), CSV (Text format)

User : Data is recorded to a user-input file name.

Serial number : A consecutive number is attached to the user-input file name to create the file name.

<Ex.>: When the file name is "TEST"

First: TEST_SER1.GBD, Second: TEST_SER2.GBD, Third: TEST_SER3.GBD

* If a file with the same name already exists, to avoid overwriting _CP* is attached to the end of the file name where the * represents a number.

<Ex.>: TEST_CP1.GBD

(3) File Type

Sets the data file format.

GBD : A data file is created by our company's original binary format.

CSV : A data file is created with the text format.

* It cannot be replayed on the GL7000.

CAUTION

Please create a folder and save the file in it. Depending on file system limitations, and regardless of the remaining free memory, saving to the root directory may not be possible.

CHECKPOINT

By changing the sample interval, recording destination or number of measured channels (number of channels where input is not Off), the free capacity and possible recording time displayed on the screen will change. After checking, if the measurement time exceeds the possible recording time, please take one of the following steps:

- Changes the sample interval.
- Copy the files at the recording destination to a PC and then delete them.
- Switch the recording destination to a high free capacity memory option. (SD card, SSD, etc.)

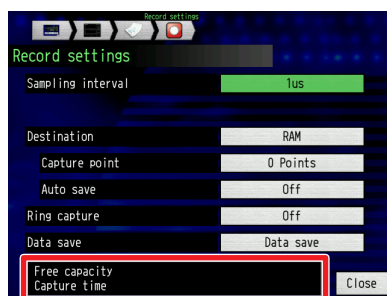

Free Memory..... Displays the amount space available to be recorded on.

Possible recording time... Displays the possible recording time.

* The possible recording time is estimated up to maximum 2GB.

- If the possible recording time exceeds 366 days, "Over 366 days" is displayed.

(2) Marker settings

Sets the marker to display on the waveform.

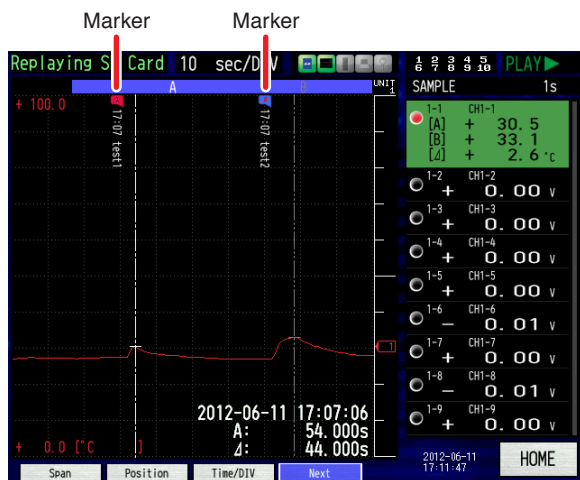

("Home" → "Machine" → "Data" → "Marker")

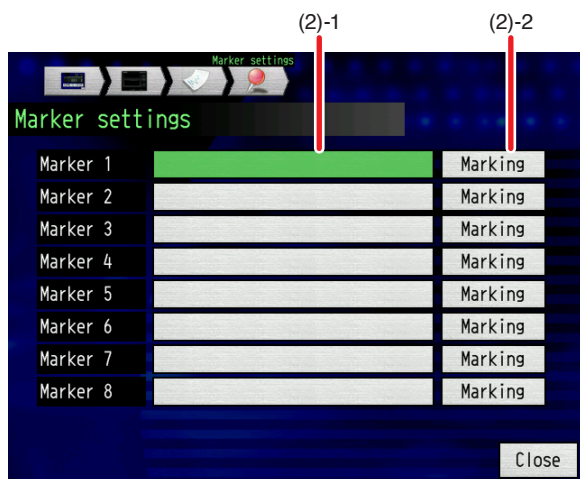

| Item select | | Examples of item |
|-------------|---------|------------------------------------|
| (2)-1 | Marker | Text input (Maximum 30 characters) |
| (2)-2 | Marking | Outputs the marker. |

(2)-1 Marker

Allows the user to set the characters that are displayed. Up to 8 settings.
Input characters are restricted to half-width alphanumeric and half-width kana.

(2)-2 Marking

The characters set in a marker can be displayed on the screen.
Outputs the marker.
The outputted marker is displayed on screen and recorded with the data.

CHECKPOINT

- The markers displayed are also saved in the recorded data.
- It is impossible to newly mark the replaying data.
- Although you can change the marker character setting during recording, the characters set when the recording is stopped or the SD card is replaced are displayed during replaying.
- A marker can be inserted in any place, but since the marker information is recorded on the data file, it affects file size.

(3) Backup settings

The GL7000 has a function that periodically backs up recording data (refer to the chart below). Here, the user can set the conditions for data backup.

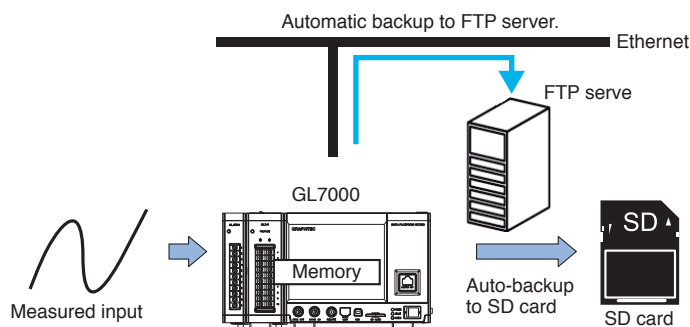

("Home" → "Machine" → "Data" → "Backup settings")

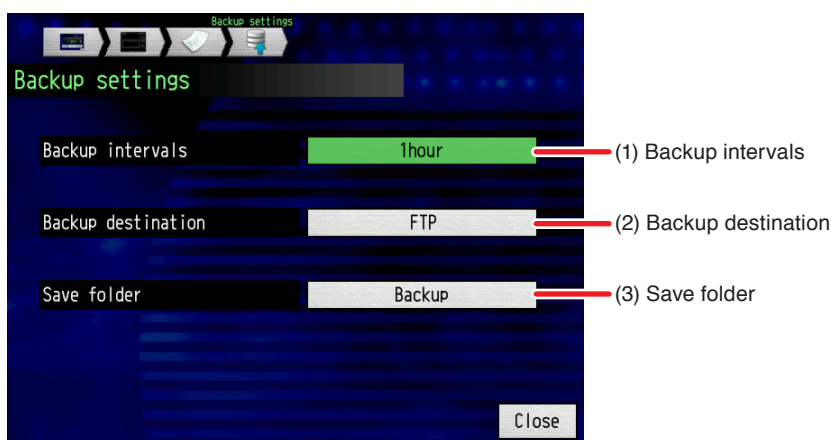

| Item select | Examples of item |
|--------------------------|--|
| (3)-1 Backup intervals | Off, 1, 2, 6, 12, 24 hour(s) |
| (3)-2 Backup destination | SD card, SSD, FTP (The recording data can be backed up to an external storage device.) |
| (3)-3 Save folder | Text input |

CHECKPOINT

- You can not specify the same location as the backup destination and recording destination.
- The recording data can be backed up to an external storage device.
- When the recording format is "CSV", the backup function is not available.
- When Ring recording is set to On, the backup function is not available.

(3)-1 Backup intervals

Sets the backup interval for recording data.

(3)-2 Backup destination

Sets the destination for data backup of the recording file. Depending on the recording destination, the selectable backup destinations changes.

| Recording destination | Backup destination | | |
|-----------------------|--------------------|-----|-----|
| | SD card | SSD | FTP |
| Built-in flash memory | OK | OK | OK |
| SD card | NG | OK | OK |
| SSD | OK | NG | OK |

(3)-3 Save folder

Sets the name of the folder to which the backup file will be saved. This becomes the backup destination folder.

(4) Output settings

This is used to output the analog voltage to the equipment to be received.

("Home" → "GL7000 setting" → "Data settings" → "Output settings")

<Output settings>

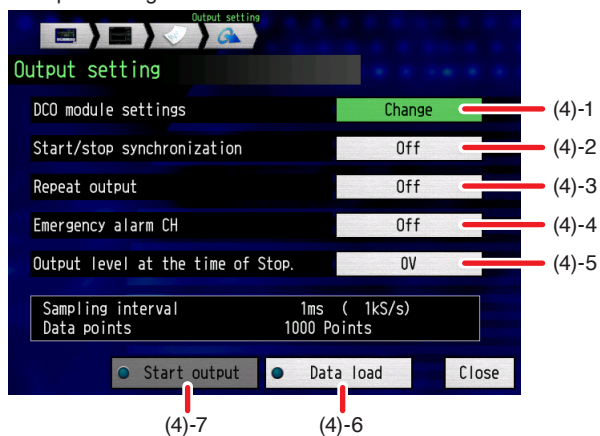

<Output settings → DCO module settings>

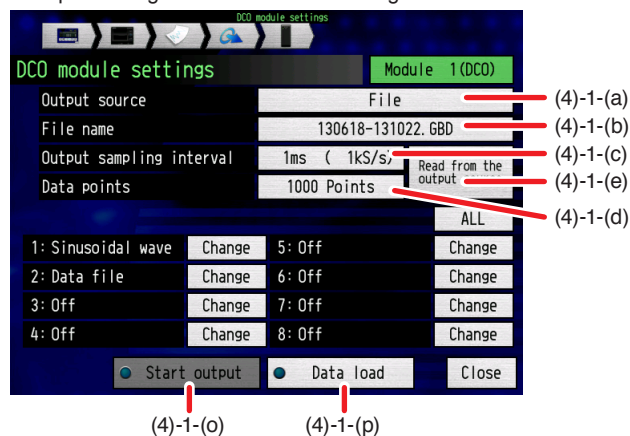

<When using Sine wave, Triangle wave, Ramp wave>



<When using Pulse wave>

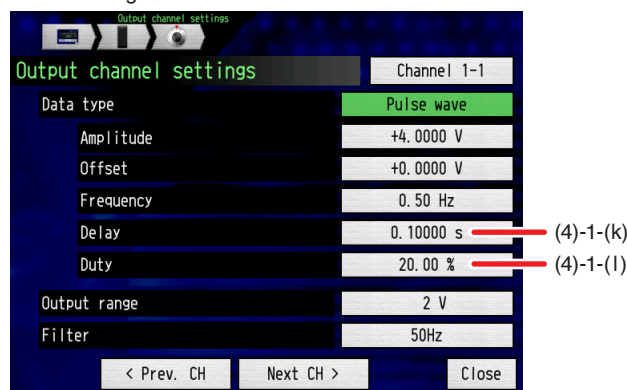

| Item select | | Examples of item | | |
|-------------|------------------------------|---|--------------------------------------|--|
| (4)-1 | (a) | DCO module | Output source | Built-in RAM, File |
| | (b) | | File name | File selection |
| | (c) | | Output sampling interval | 10ms (100kS/s), 20ms (50kS/s), 50ms (20kS/s), 100ms (10kS/s), 200ms (5kS/s), 500ms (2kS/s), 1ms (1kS/s), 2ms (500S/s), 5ms (200S/s), 10ms (100S/s), 20ms (50S/s), 50ms (20S/s), 100ms (10S/s), 125ms (8S/s), 200ms (5S/s), 250ms (4S/s), 500ms (2S/s), 1s (1S/s), 2s, 5s, 10s, 20s, 30s, 1min, 2min, 5min, 10min, 20min, 30min, 1h |
| | (d) | | Data points | 1 to 128,000,000 points |
| | (e) | | Read from the output source | Reading the file data conditions |
| | (f) | Setting (ALL, 1CH to 8CH) | Data type | Off, Data file, DC, Sine wave, Triangle wave, Ramp wave, Pulse wave |
| | (g) | | Amplitude | 0.000 to +20.000V |
| | (h) | | Offset | -10.000 to +10.000V |
| | (i) | | Frequency | 0.00 to 10,000.00Hz |
| | (j) | | Phase | -360.0 to +360.0deg. |
| | (k) | | Delay | 0.00000 to 100.00000sec. |
| | (l) | | Duty | 0.00 to 100.00% |
| | (m) | | Output rage | 1, 2, 5, 10V |
| | (n) | Filter | Off, Line, 5 / 50 / 500Hz, 5 / 50kHz | |
| (o) | Data load | Reading the analog voltage output data and conditions | | |
| (p) | Start output | Analog voltage output start / output stop | | |
| (4)-2 | Start / Stop synchronization | | Off, On | |

| Item select | | Examples of item |
|-------------|----------------------------------|--|
| (4)-3 | Repeat output | Off, On |
| (4)-4 | Emergency stop alarm CH | Off, CH1, CH2, CH3, CH4, CH5, CH6, CH7, CH8, CH9, CH10 |
| (4)-5 | Output level at the time of Stop | 0V, Retain |
| (4)-6 | Data load | Reading the analog voltage output data and conditions |
| (4)-7 | Start output | Analog voltage output start / output stop |

(4)-1 DCO module settings

Set the Voltage Output Module (GL7-DCO).
This can be set from "Home" → "DCO module".

(4)-1-(a) Output source

Select the processing destination in which the analog voltage data has been recorded.
Built-in RAM: The data recorded in the built-in RAM in the module.
File: The data in the recording destination (storage media)

(4)-1-(b) File name

When the output source is set to File in (4)-1-(a), select the data file in the recording destination.
However, when the built-in RAM is selected, this item is not displayed.

CHECKPOINT

The file to be use here is GBD file data (binary format) only.
When the CSV file wave-generated by the GL-WaveEditor (software supplied with the GL-Connection) is saved, the CSV file can be converted to the GBD file data with the conversion saving function (refer to "Convert then save" in "11-11-2. File Operations") of the GL-Connection.

(4)-1-(c) Output sampling interval

The data output interval for the analog voltage output can be set within the range of 10_s to 1h.

(4)-1-(d) Data points

Set the data points for the analog voltage output. The data points can be set up to 28,000,000 points.

CHECKPOINT

When the data type is set to Data file, the data with more data points than the recording points is the same as the analog voltage of the last data in data file.

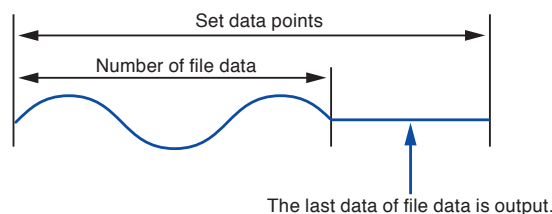

* When the set data points are less than the number of file data, the data for the set data points is output.

(4)-1-(e) Read from the output source

The sampling interval and the data points are read from the data in the output source (built-in RAM or file) set in (4)-1-(a), and then they are set to the output sampling interval in (4)-1-(c) and the data points in (4)-1-(d).

CHECKPOINT

When you set to Data file, please use the GL7000 after checking the followings. (GBD file data only is available.)

- If the data has not been saved to the built-in RAM or the specified file does not exist, the corresponding output CH will be 0V data.
- If specifying the CH that does not exist in the data file, the corresponding output CH will be 0V data.
- If specifying the CH recorded when "Temperature / Humidity and Logic / Pulse" are input in the data file, the corresponding output CH will be 0V data.
- In the data output sampling interval, the data is output with the output sampling interval set in "(4)-1-(c) Output sampling interval", regardless of the sampling interval recorded in the data file.

(4)-1-(f) Settings (Data type)

Select the data type and set the output conditions. The data in the data file is output within the set output range, regardless of the full scale range of the file.

The following table shows the settings and setting range.

| Settings | Amplitude | Offset | Frequency | Phase | Delay | Duty |
|---------------|-----------|--------|------------|------------------|--------------|-----------|
| Data type | 0 to 20V | ±10V | 0 to 10kHz | -360 to +360deg. | 0 to 100sec. | 0 to 100% |
| Data file | NG | NG | NG | NG | NG | NG |
| DC | OK | OK | NG | NG | NG | NG |
| Sine wave | OK | OK | OK | OK | NG | NG |
| Triangle wave | OK | OK | OK | OK | NG | NG |
| Ramp wave | OK | OK | OK | OK | NG | NG |
| Pulse wave | OK | OK | OK | NG | OK | OK |

Sine wave

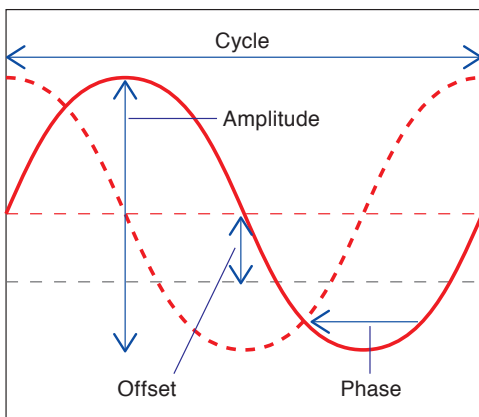

Triangle wave

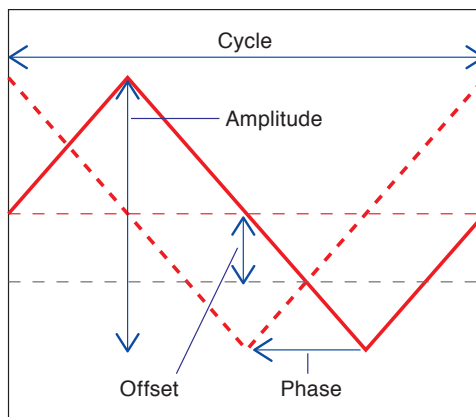

Ramp wave

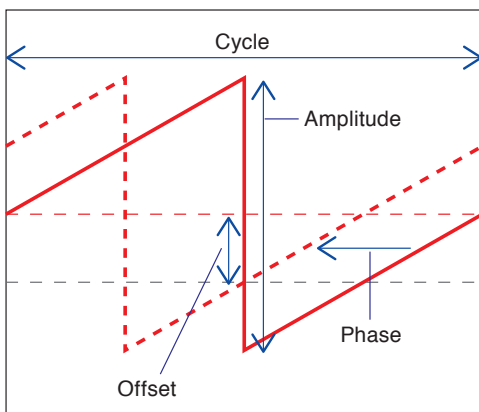

Pulse wave

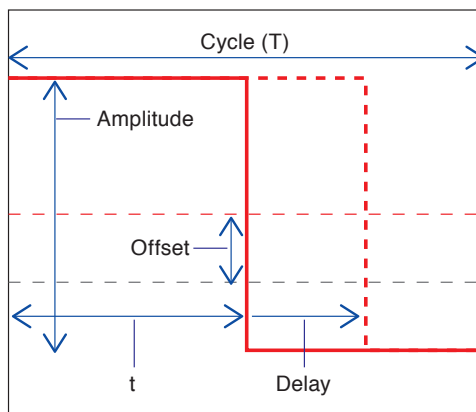

$$\text{Duty ratio} = \frac{t}{T}$$

(4)-1-(g) Setting (Amplitude)

The amplitude (P-P) can be set up to two times of the output range.

<Example> Output range 1V: Normal amplitude 1V (P-P), Maximum settable amplitude 2V (P-P)

(4)-1-(h) Setting (Offset)

The offset can be set within the output range.

<Example> Output range 1V: within the range of $\pm 1V$

(4)-1-(i) Setting (Frequency)

The frequency can be set within the range of 0.00 to 10000.00Hz.

Approx. 1/10 cycle of the output sampling interval is a criteria.

<Example> Sampling interval 1ms (1kHz): 0.01 to 100.00Hz

(4)-1-(j) Setting (Phase)

The phases of Sine wave, Triangle wave and Ramp wave can be set within the range of -360.0 to +360.0 deg.

(4)-1-(k) Setting (Delay)

When setting the pulse wave, the delay can be set within the range of 0.00000 to 100.0000sec.

(4)-1-(l) Setting (Duty)

When setting the pulse wave, the duty can be set within the range of 0.00 to 100.00%.

(4)-1-(m) Setting (Output range)

Set the analog voltage output.

The output range can be set to 1V, 2V, 5V or 10V. Maximum amplitude can be output up to two times of each range (Set in Amplitude screen).

(4)-1-(n) Setting (Filter)

A filter for the analog voltage output signal can be set.

This filter is a smoothing filter that removes the noise of the D/A converter.

CHECKPOINT

The filter for the output waveform should be set to Faster. If the filter is set to Slower, the waveform is may be shrunk or distorted.

(4)-1-(o) Data load

When changing the settings, the settings are confirmed by loading the data.

CHECKPOINT

- When the data load is not executed, the settings are not updated and remain the settings before changing. Make sure that the data load is executed.
- The data load operation is enabled when the output is stopped. It is not possible to operate the data load during data output. The following figure shows the displayed contents.

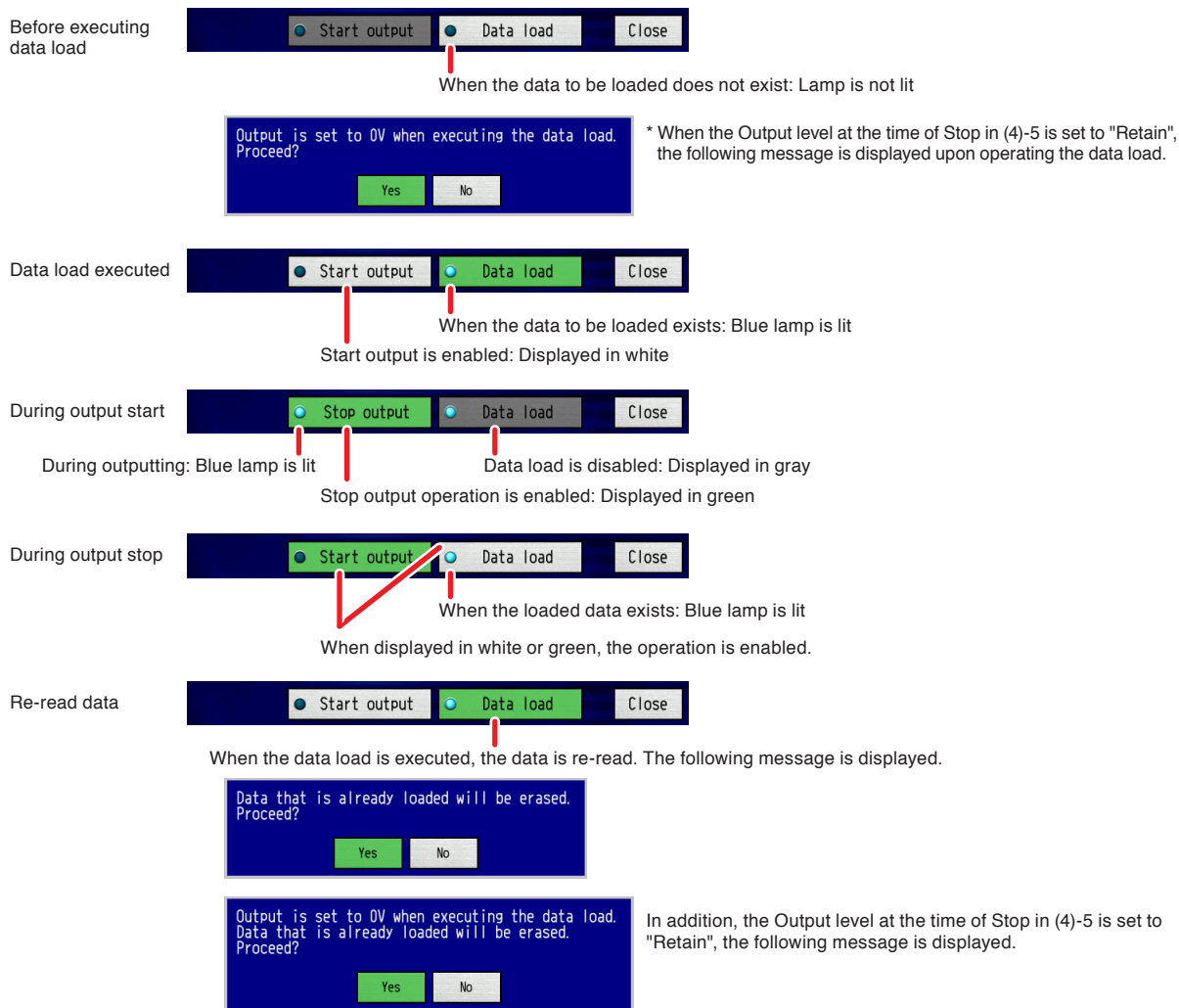

(4)-1-(p) Start output

When operating the Start output, the analog voltage output is executed.

To stop the analog voltage output, operate the Stop output.

When the start output key operation is disabled (displayed in gray), the data load is not executed. Make sure that the data load has been executed.

For the displayed contents, refer to "(4)-1-(o) Data load".

CHECKPOINT

- The analog voltage output at the time of stop conforms to the conditions set in "(4)-5 Output level at the time of Stop".
- * When the Output level at the time of Stop is set to "Retain", the voltage value at the time of stop is output.

(4)-2 Start/Stop synchronization

When the Start / Stop synchronization is set to On, the analog voltage output is started at the same time as the GL7000 start, and the output is stopped at the same time as the GL7000 stop (free-running state).
When the Start / Stop synchronization is set to Off, it is possible to operate the start output / stop output described in "(4)-1-(p) or (4)-7 Start output", regardless of the start / stop of GL7000.

CHECKPOINT

The analog voltage output at the time of stop conforms to the conditions set in "(4)-5 Output level at the time of Stop".
* When the Output level at the time of Stop is set to "Retain", the voltage value at the time of stop is output.

(4)-3 Repeat output

When the Repeat output is set to On, the analog voltage is repeatedly output until the stop operation is executed.

(4)-4 Emergency stop alarm CH output

When the alarm output CH is specified to the alarm module in the GL7000, the analog voltage output is forcibly stopped when the alarm occurs.

(4)-5 Output level at the time of Stop

The analog voltage output conditions when the output is stopped can be set.

0V: The analog voltage output is 0V.

Retain: The voltage value at the time of stop continues to output as the analog voltage output.

CAUTION

- When the analog voltage is output after setting to Retain, please take care in handling the equipment to be received.
- To turn the analog voltage output to 0V, execute the re-load data.

(4)-6 Data load

This data load is linked with the operation described in "(4)-1-(o) Data load". So it is possible for both operations.

(4)-7 Start output

This Start output is linked with the operation of "(4)-1-(p) Start output". So it is possible to execute for both operations.

(5) Trigger/Alarm settings

Carries out trigger condition settings and alarm settings.

("Home" → "Machine" → "Trigger/Alarm settings" or "Home" → "Amplifire settings" → "Trigger")

<Example 1> Start Trigger: Level
Stop Trigger: Alarm

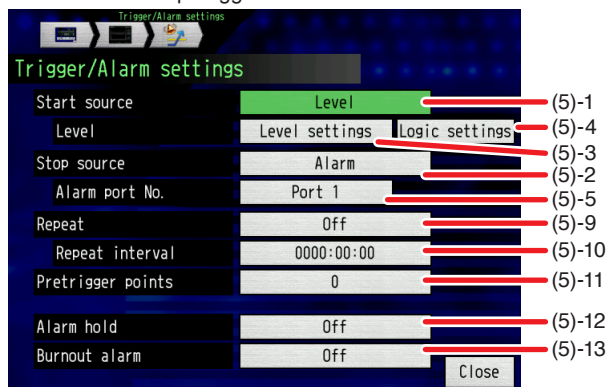

<Example 2> Start Trigger: Set time
Stop Trigger: Set date

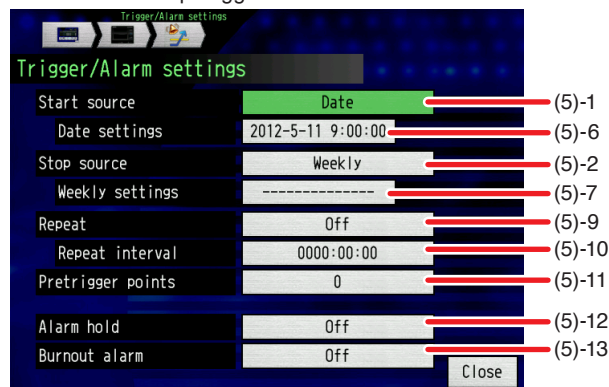

<Example 3> Start Trigger: External input
Stop Trigger: Time interval

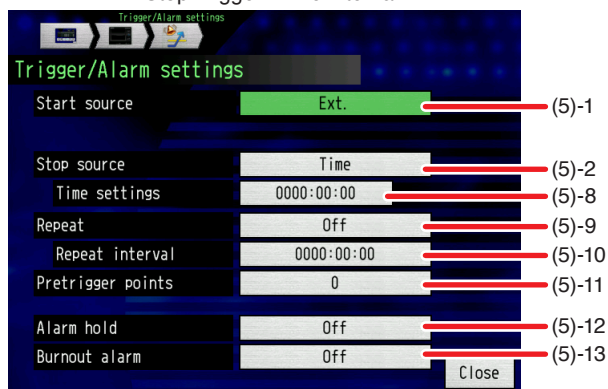

* Alarm levels and other detailed settings can not be set on this screen. Done in "Amplifire settings" → "Alarm settings"

| Item select | | Examples of item | |
|-------------|-------------------|---|---|
| (5)-1 | Start source | Off ,Level ,Alarm ,Ext. ,Date ,Weekly ,Time | |
| (5)-3 | Level | Level settings | |
| (5)-4 | | Logic settings | |
| (5)-5 | Alarm | Alarm port number | 1 to 10 |
| (5)-6 | Date | Date settings | Date |
| | | | Time |
| | | | Jan. 1, 2000 to Dec. 31, 2035 |
| (5)-7 | Weekly | Weekly settings | Weekly |
| | | | Time |
| | | | Sets the days from Sunday to Saturday individually to On or Off |
| (5)-8 | Time | Time settings | Time |
| | | | |
| | | | 00:00:00 to 23:59:59 |
| (5)-2 | Stop source | Off, Level, Alarm, External, Time, Date, Set | |
| (5)-3 | Level | Level settings | |
| (5)-4 | | Logic settings | |
| (5)-5 | Alarm | Alarm port No. | 1 to 10 |
| (5)-6 | Date | Date settings | Date |
| | | | Time |
| | | | Jan. 1, 2000 to Dec. 31, 2035 |
| (5)-7 | Weekly | Weekly settings | Weekly |
| | | | Time |
| | | | Sets the days from Sunday to Saturday individually to On or Off |
| (5)-8 | Time | Time settings | Time |
| | | | |
| | | | 0:00:01 to 9999:59:59 |
| (5)-9 | Repeat | Off, On | |
| | | [ON] | Repeat interval |
| | | | 0:00:01 to 9999:59:59 |
| (5)-10 | Pretrigger points | 0 to Number of recording points (Numerical entry) | |
| (5)-11 | Alarm hold | Off, On | |
| (5)-12 | Burnout alarm | Off, On | |

(5)-1 Start source

Sets the trigger conditions for starting data recording

| Item select | Description |
|-------------|---|
| Off | If the Start/Stop button is pressed, recording starts regardless of condition settings. |
| Level | Recording starts if the conditions are satisfied at the level set. ⇒ When selecting the level value, the conditions for each CH is set. Refer to "(12) Trigger level settings" on page 3-105. |
| Alarm | Recording starts if an alarm occurs at a specified port. |
| Ext. | Recording starts at an input signal from the external trigger terminal (REMOTE terminal). * Trigger occurs when L (OV or shorted to GND) occurs. Operations will become edge operations. Please input a signal over 500 μs. |
| Date | Recording starts at a specified date and time. |
| Weekly | Recording starts at a specified time on the date it's set to On. <Ex.>: Set Mon, Tue, Wed, Thu, Fri to On and Sun, Sat to Off and specify the time as 9:00. Recording starts at 9:00 on weekdays. Recording is not started on a Saturday. |
| Time | Recording starts when the specified time has elapsed. |

(5)-2 Stop source

Sets trigger conditions for stopping data recording.

| Item select | Description |
|-------------|--|
| Off | If the Start/Stop button is pressed, recording stops regardless of condition settings. |
| Level | Recording stops if the conditions are satisfied at the level set. ⇒ When selecting the level value, the conditions for each CH is set. Refer to "(12) Trigger level settings" on page 3-105. |
| Alarm | Recording starts if an alarm occurs at a specified port. |
| Ext. | Recording stops at an input signal from the external trigger terminal (REMOTE terminal). * Trigger occurs when L (OV or shorted to GND) occurs. Operations will become edge operations. Please input a signal over 500 μs. |
| Date | Recording stops at a specified date and time. |
| Weekly | Recording stops at a specified time on the date it's set to On. <Ex.>: Set Mon, Tue, Wed, Thu, Fri to On and Sun, Sat to Off and specify the time as 9:00. Recording starts at 9:00 on weekdays. Recording is not started on a Saturday. |
| Time | Recording stops when the specified time has elapsed. |

CHECKPOINT

When using the stop trigger, set the interval between the start side and stop side to 1 ms or more. If the trigger on the stop side occurs within 1 ms after the trigger on the start side occurs, the recording stops after 1 ms elapsed from the start side. However when the recording destination is the built-in RAM, the recording stops within 1 ms at the point that the number of recording points are exceeded.

(5)-3 Level settings

For details, refer to "(12) Trigger level settings" on page 3-105.

(5)-4 Logic settings

For details, refer to "(12) Trigger level settings" on page 3-105.

(5)-5 Alarm port number

If an alarm occurs at the port specified here, a start or stop trigger is established.

(5)-6 Date setting

Sets the date and time. At the set date and time, a start or stop trigger is established.

(5)-7 Weekly settings

Sets weekly and time. Sets the weeklys from Sunday to Saturday individually to On or Off. At a specified time on a weekly set to On, a start or stop trigger is established.

(5)-8 Time settings

If the specified time has elapsed, a start or stop trigger is established.

(5)-9 Repeat

Sets the repeat function for performing repeat recording.

* This setting can only be set when the recording destination is the built-in RAM or when the stop side source is not set to Off.

| Item select | Description |
|-------------|--|
| Off | Cannot use the repeat function. |
| On | Repeat function enabled. After 1 recording has finished, the next recording will start. (If the start side source is set to On, recording will become trigger dependent.) |

<Repeat settings table>

| Recording destination | Stop side trigger source | | | | | | |
|-----------------------|--------------------------|-------|-------|------|------|--------|------|
| | Off | Level | Alarm | Ext. | Date | Weekly | Time |
| RAM | OK | OK | OK | OK | OK | OK | OK |
| Internal FLASH | NG | OK | OK | OK | OK | OK | OK |
| SD Card | NG | OK | OK | OK | OK | OK | OK |
| SSD Module | NG | OK | OK | OK | OK | OK | OK |

OK: Settings available

(5)-10 Repeat interval

When the repeat recording function is set to On, the repeat interval can be set.

As soon as the time set in the repeat interval has elapsed, the recording start processing is performed, waiting to be triggered again.

CHECKPOINT

Depending on the state (such as space, number of files) of the recording destination, the processing may take a long time to start recording.
Therefore, it may take some time until the waiting for a trigger after the repeat interval has elapsed.

(5)-11 Pretrigger points

Sets the number of recording points for the recorded data before a trigger occurs.

* This can only be selected if the Pretrigger points is set to record to the built-in RAM, and the start side source is set to a level value or an external input.

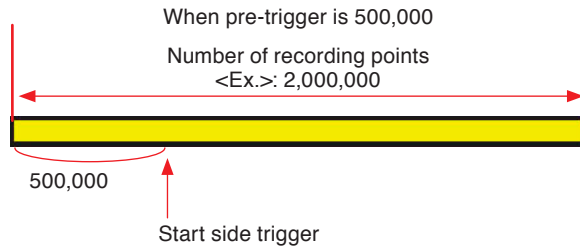

<Pretrigger points settings table>

| Recording destination | Stop side trigger source | | | | | | |
|-----------------------|--------------------------|-------|-------|------|------|--------|------|
| | Off | Level | Alarm | Ext. | Date | Weekly | Time |
| RAM | NG | OK | OK | OK | OK | OK | OK |
| Internal FLASH | NG | NG | NG | NG | NG | NG | NG |
| SD Card | NG | NG | NG | NG | NG | NG | NG |
| SSD Module | NG | NG | NG | NG | NG | NG | NG |

OK: Settings available

(5)-12 Alarm hold

If "Alarm hold" is selected here, once the established conditions have been met the alarm status will not be cleared, regardless of whether or not the conditions continue to be met (Touching the function button or "QUIT" key on the screen will clear it.)

CHECKPOINT

When the combination of the alarms is set to "Edge OR" or "Edge AND", the alarms are retained regardless of this setting.

When the alarms are not retained, set the combination of the alarms to "Level OR" or "Level AND".

(5)-13 Burnout alarm

If "Occurs" is selected here, when a burnout (refer to "(3) Burn out" on page 3-76) occurs, an alarm is output from the alarm output terminal. From the CH settings screens it is possible to set the number for the output destination.

(For details, see ""(13)-4 Output" on page 3-111)

(6) I/F, USB settings

Sets the conditions for connecting to a computer. Ethernet settings are set in the network settings, a different menu.

("Home" → "Machine" → "I/F, USB settings")

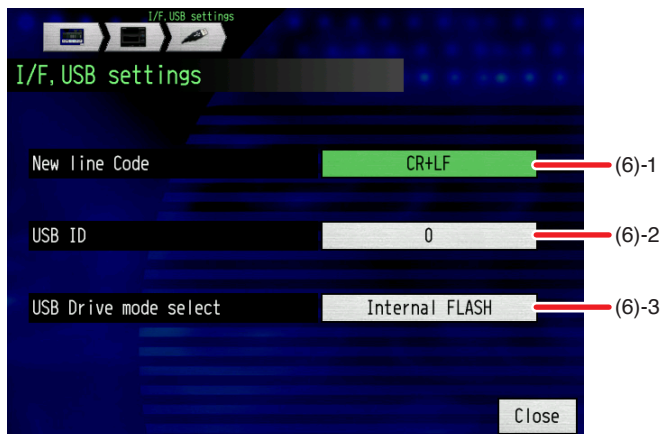

| Item select | | Examples of item |
|-------------|-----------------------|-------------------------------------|
| (6)-1 | New line Code | CR+LF, LF, CR |
| (6)-2 | USB ID | 0 to 9 |
| (6)-3 | USB Drive mode select | Internal FLASH, SD Card, SSD Module |

(6)-1 New line Code

Sets the lower line character for managing with I/F commands.

| Item select | Description |
|-------------|-----------------------|
| CR+LF | Line break with CR/LF |
| LF | Line break with LF |
| CR | Line break with CR |

(6)-2 USB ID

Sets the USB ID number for the GL7000.

It can be set between 0 and 9.

When managing multiple machines with 1 computer, please set the USB IDs so that they do not overlap.

(6)-3 USB Drive mode select

Sets the USB Drive Mode destination for the GL7000.

May be set from the built-in flash memory, SD card, SSD (when the SSD module is mounted).

Please see page 3-41 "USB Drive Mode".

(7) IP settings

Settings for connecting to the GL7000 by Ethernet.

("Home" → "Machine" → "Network settings" → "IP settings")

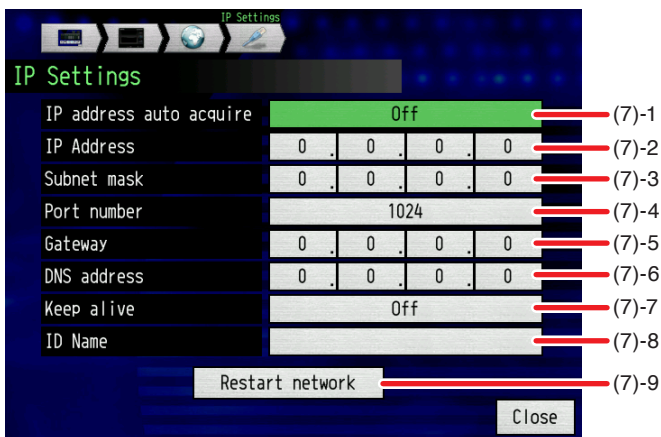

| Item select | | Examples of item |
|-------------|-------------------------|---|
| (7)-1 | IP address auto acquire | On (Use), Off (Don't use) |
| (7)-2 | IP Address | 0 to 255 |
| (7)-3 | Subnet mask | 0 to 255 |
| (7)-4 | Port number | 1024 to 65535 |
| (7)-5 | Gateway | 0 to 255 |
| (7)-6 | DNS address | 0 to 255 |
| (7)-7 | Keep alive | Off, 10 and 30 sec., 1, 10 and 30 min., 1 hr. |
| (7)-8 | ID Name | Text input |
| (7)-9 | Restart network | ▷ Execute |

CHECKPOINT

Settings (7)-1 through (7)-6 manage network connections for the GL7000. Please consult you network administrator before making any changed.

(7)-1 IP address auto acquire

Sets whether the IP address should be acquired automatically or entered manually.

| Item select | Description |
|-----------------|---|
| On (Use) | Sets it to automatic acquisition. (7)-2, (7)-3, (7)-5, (7)-6 cannot be selected. * When setting it to "Use", the automatic acquisition action (occurs when the power is turned on or when executing settings reflecting) may take from a few seconds up to 1 minute. |
| Off (Don't use) | Sets it to manual entry. Please set the (7)-2 to (7)-6 items in the table above. |

<When IP address is successfully auto-accrued>

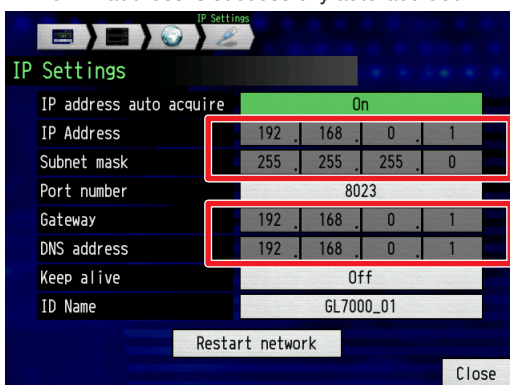

<When IP address is not auto-accrued>

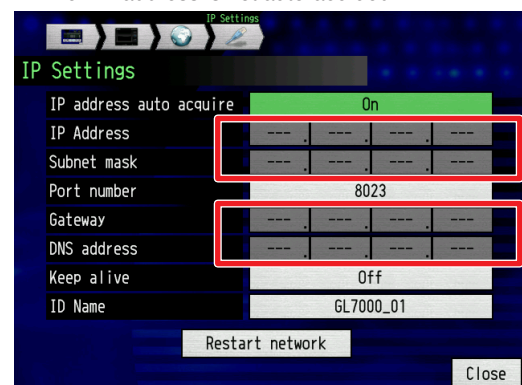

After a successful automatic acquisition, the automatically set IP address is displayed.

⚠ CAUTION

- When an IP address cannot be acquired despite automatic IP address acquisition being set to "Use" (refer to the following chart), operate by manually setting IP address contents etc. As the IP address may not fit the used network settings, please set automatic IP address acquisition to "Don't use" and enter settings here.
- When changing IP settings, turn the power off and on, or execute "Network restart". (The connection will be forcibly disabled.)

(7)-2 IP address

Sets the IP address for the GL7000.

This can only be set when the machine is set to manual IP address entry.

(7)-3 Subnet mask

Sets the subnet mask for the GL7000.

This can only be set when the machine is set to manual IP address entry.

(7)-4 Port number

Sets the port number for the GL7000.

(7)-5 Gateway

Sets the gateway address for the GL7000.

This can only be set when the machine is set to manual IP address entry..

(7)-6 DNS address

Sets the DNS address for the GL7000.

This can only be set when the machine is set to manual IP address entry.

(7)-7 Keep alive

Detects the Keep Alive and automatically disconnects the socket connector.

| Item select | Description |
|--|---|
| Off | Disconnection is not performed. |
| 10 and 30 sec., 1, 10 and 30 min., 1 hr. | Lack of activity over a certain amount of time will lead to the socket connection being disconnected. Please engage the machine within that time limit. (This function is only enabled for the command port. It has no effect on the Web server and FTP server functions.) |

(7)-8 ID Name

Sets the name for identifying the attached application.

* This identification name is neither a general computer name (NETBIOS name) nor a name for DNS use.

(7)-9 Restart network

For instantly reflecting IP settings contents.

* When executing settings reflecting, the connection will be forcibly cut.

* Executing settings reflecting may take from a few seconds up to 1 minute.

(8) FTP server settings

Sets information concerning the connected FTP server for backup, etc.

("Home" → "Machine" → "Network settings" → "FTP Server settings")

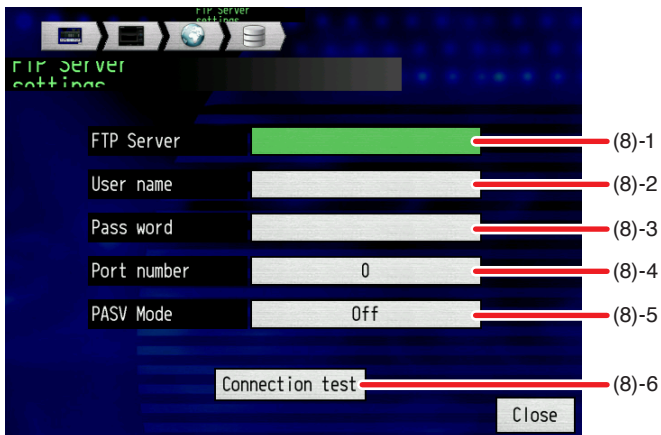

| Item select | | Examples of item |
|-------------|-----------------|------------------|
| (8)-1 | FTP Server | Text input |
| (8)-2 | User name | Text input |
| (8)-3 | Pass word | Text input |
| (8)-4 | Port number | 0 to 65535 |
| (8)-5 | PASV Mode | Off, On |
| (8)-6 | Connection test | ▷ Execute |

(8)-1 FTP Server

Enter the FTP server domain name or IP address.

(8)-2 User name

Enter the FTP account username.

(8)-3 Pass word

Enter the FTP account password.

(8)-4 Port number

Enter the port number used with FTP. Normally this number is 21.

(8)-5 PASV Mode

Set the passive mode.

| Item select | Description |
|-------------|---|
| Off | Set when communicating with the FTP server in a normal network environment. |
| On | Set when communicating with an external firewall in a firewalled network environment. |

(8)-6 Connection test

Carries out connection test on the FTP server. A message is displayed when carrying out the connection test. If connection cannot be made, please check setting and test again.

* If the connection test comes out OK, the message below is displayed.

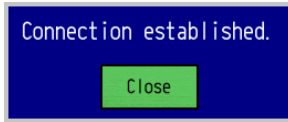

CHECKPOINT

- If the factory settings are used and the setting conditions are initialized, the settings for the FTP server are also initialized.
 - If the configuration of the modules is changed, the setting conditions is initialized and then the settings for FTP serve are also initialized.
-

(9) Date/Time settings

Settings related to the clock.

Here you can set the GL7000 built-in clock (date and time). Further, by setting the network time, the GL7000 clock can be automatically adjusted via the network.

("Home" → "Machine" → "Date/Time settings")

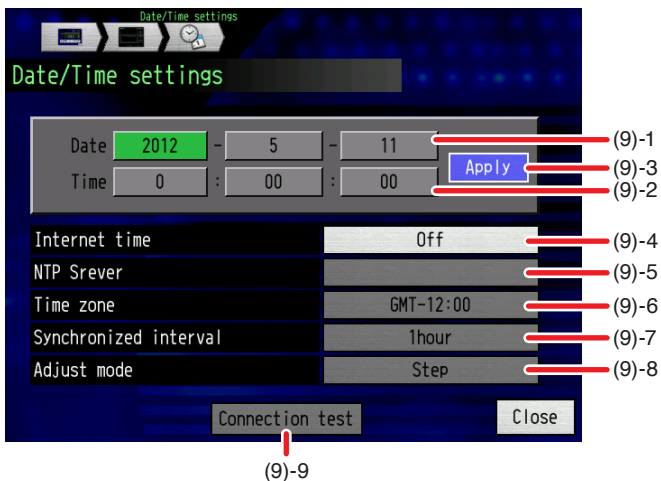

| Item select | Examples of item |
|-----------------------------|-------------------------------|
| (9)-1 Date | Jan. 1, 2000 to Dec. 31, 2035 |
| (9)-2 Time | 00:00:00 to 23:59:59 |
| (9)-3 Apply | ▷ Execute |
| (9)-4 Internet time | Off, On |
| (9)-5 NTP server | Text input |
| (9)-6 Time zone | -12:00 to +13:00 (hourly) |
| (9)-7 Synchronized interval | 1, 2, 6, 12 and 24 hrs |
| (9)-8 Adjust mode | Step, Slew |
| (9)-9 Connection test | ▷ Execute |

(9)-1 Date

Sets the date. By pressing the "Apply" button, settings are reflected

(9)-2 Time

Sets the time. By pressing the "Apply" button, settings are reflected.

(9)-3 Apply

By pressing this button, date/time settings are reflected.

(9)-4 Internet time

Sets whether or not to use this function.

| Item select | Description |
|-------------|---|
| Off | This function is not used. Time adjustment not implemented. |
| On | Using this function, time adjustment implemented |

(9)-5 NTP server

Input the domain name of the time server (NTP server) in use.

(9)-6 Time zone

Sets the time zone for the area the GL7000 is being used in.

(9)-7 Synchronized interval

Sets the interval for synchronizing to the time server. Time synchronization is performed in the way set in synchronization mode settings when the synchronization interval is up. The elapsed time measurement can be set when this item is set or following startup.

(9)-8 Adjust mode

Sets the synchronization method to the clock server.

| Item select | Description |
|-------------|--|
| Step | When the synchronization interval elapses, the time is immediately set using the server time. |
| Slew | Even if the synchronization interval elapses, immediate synchronization is not carried out. The time is gradually synchronized to the server time. The adjustment amount is approx. 43 seconds/day. (20 seconds is about 10ms of adjustment amount.) |

(9)-9 Connection test

Carries out a connection test to the time server.

A message is displayed when carrying out the connection test. If connection cannot be made, please check the settings and test again.

* If the connection test is OK, the message below is displayed.

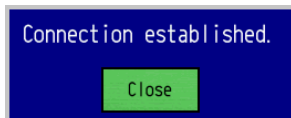

CHECKPOINT 

- If the factory settings are used and the setting conditions are initialized, the settings for the FTP server are also initialized.
 - If the configuration of the modules is changed, the setting conditions is initialized and then the settings for FTP server are also initialized.
-

(10) Other settings

Various setting conditions can be set.

("Home" → "Machine" → "Other Settings")

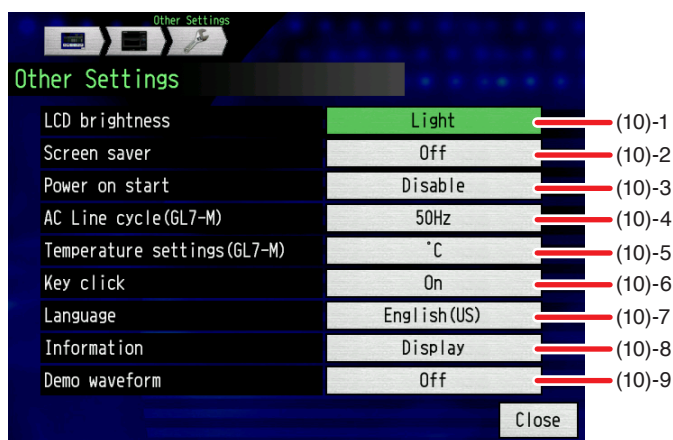

| Item select | | Examples of item | |
|-------------|---------------------|---|--------------------|
| (10)-1 | LCD brightness | Lightest, Light, Medium, Dark, Darkness | |
| (10)-2 | Screen saver | Off, 10/30s, 1/2/5/10/30/60min | |
| (10)-3 | Power on start | Disabled, Enabled | |
| (10)-4 | AC Line cycle | 50Hz, 60Hz | |
| (10)-5 | Temperature setting | Temperature unit | °C, °F |
| | | Room temperature | Internal, External |
| | | Burn out | Off, On |
| (10)-6 | Key click | Off, On | |
| (10)-7 | Language | Japanese, English(US), English(UK), French, German, Chinese, Korean | |
| (10)-8 | Information | ▽ Information display | |
| (10)-9 | Demo waveform | Off, On | |

(10)-1 LCD brightness

Sets the LCD backlight brightness.

When set darker, LCD life can be prolonged.

(10)-2 Screen saver

Turns the screen Off automatically, at a specified time during inactivity.

The life span of the LCD screen may be prolonged by frequently turning off the screen.

(10)-3 Power on start

Sets the function for automatically starting recording at set conditions when the power is turned on.

| Item select | Description |
|-------------|--|
| Disable | Will not start recording when powered. |
| Enable | Will start recording when powered. |

CHECKPOINT

- When this function is set to "Enable" and the start side trigger is not set to OFF, turning the power on becomes a time dependent trigger and recording will not start until the trigger is activated.
- When using the Voltage Output Module, even if the power is turned on after setting "Power-on start" or "Start / Stop synchronization" of the Voltage Output Module, the voltage output is not performed. Users must be operated manually in the DCO module settings

(10)-4 AC Line cycle

This is set for an option module GL7-M only.
Sets the frequency of the AC power source in use.

| Item select | Description |
|-------------|--|
| 50Hz | For a region with a power frequency of 50Hz. |
| 60Hz | For a region with a power frequency of 60Hz. |

CAUTION

- This setting is a disposable frequency for the Voltage/Temperature digital file.
- Please note that setting this mistakenly may mean that the noise from the power source cannot be cancelled out.
- The sample interval where the digital file is enabled is over 500ms.

(10)-5 Temperature setting

This is set for an option module GL7-M only.
Sets temperature related settings.

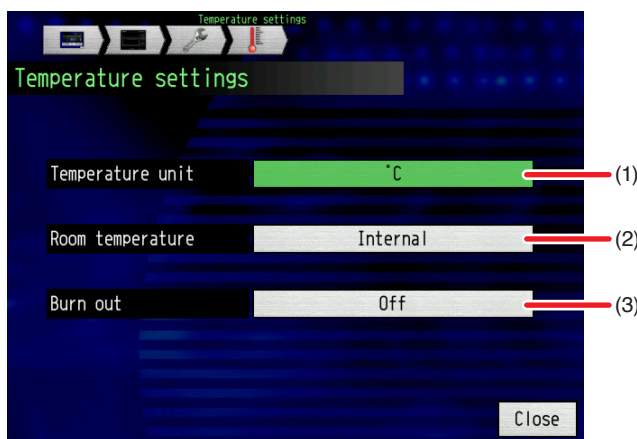

| Item select | Description |
|----------------------|---|
| (1) Temperature unit | Changes between °C (Celsius) and °F (Fahrenheit) settings. |
| (2) Room temperature | Sets whether to enable or disable the GL7000 room temperature compensation. |
| (3) Burn out | Sets the thermocouple disconnection check function. |

- (1) Temperature unit
°F (Fahrenheit) is calculated with the following formula.
°F (Fahrenheit) = °C (Celsius) × 1.8 + 32

CAUTION

- Regarding accuracy, please calculate an accurate Celsius × 1.8.
- Temperature can be measured in Fahrenheit is up to 2900°F. If the temperature exceeds 2900°F, "++++" is displayed.

- (2) Room temperature

| Item select | Description |
|-------------|--|
| Internal | Room temperature compensation is enabled for the GL7000. (Recommended) |
| External | Set when performing room temperature compensation for an external machine. |

- (3) Burn out

| Item select | Description |
|-------------|---|
| Off | Disconnection check is not done. |
| On | Disconnection checks are made periodically. |

CAUTION

Voltage is applied during disconnection checks. When in a parallel connection with other machines, please set this to Off as it can have an effect on the other machines.

(10)-6 Key click

Sets the sound for key operations of the GL7000.
Select from On, Off.

(10)-7 Language

Sets the GL7000 display language.

(10)-8 Information

Displays the GL7000 system information.

(10)-9 Demo waveform

Displays a demo waveform, without inputting an analogue signal.

| Item select | Description |
|-------------|---------------------------------|
| Off | Demo waveform is not displayed. |
| On | Demo waveform is displayed. |

CHECKPOINT

Since GL7000 starts up as if one pseudo-Voltage module (GL7-V) is installed even if the Amplifier module has not been installed, you can verify the demo waveforms.

(11) Input settings

Mainly used for input signal settings.

("Home" → "Each Amplifier Module" → "Channel settings" → "Input settings")

<Voltage module (GL7-V)>

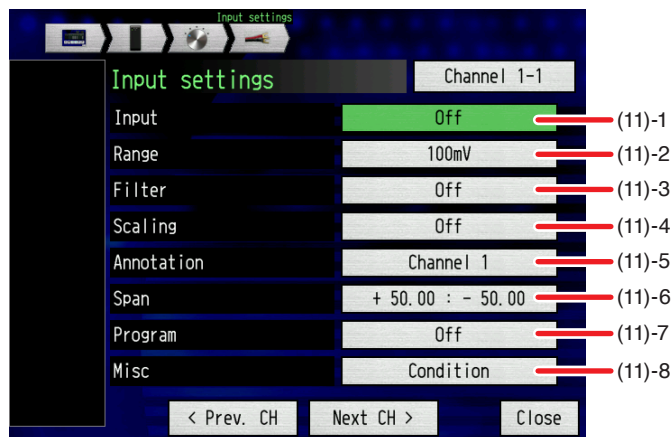

| Item select | | Examples of item | | | |
|-------------|---|--|--|---|--|
| (11)-1 | Input | Off, DC | | | |
| (11)-2 | Range | 100/200/500mV, 1/2/5/10/20/50/100V, 1-5V | | | |
| (11)-3 | Filter | Off, Line, 5/50/500Hz | | | |
| (11)-4 | Scaling | Scaling | Off, On | | |
| | | Meas. Value | Upper limit value | Numerical entry | |
| | | | Lower limit value | Numerical entry | |
| | | Scal. Value | Upper limit value | Numerical entry | |
| | | | Lower limit value | Numerical entry | |
| | | Decimal point | +1.0000, +10.000, +100.00, +1000.0, +10000 | | |
| | | Select | Categories | Current, Length, Area, Volume, Acceleration, Frequency, Mass, Energy, Pressure, Flow, Temperature, Strain | |
| | | | Unit selection | (Item selection changes depending on the groups mentioned above) | |
| Unit | The above unit selection result or character entry. | | | | |
| (11)-5 | Annotation | Text input (up to 31 characters) | | | |
| (11)-6 | Span | Upper limit value | Numerical entry | | |
| | | Lower limit value | Numerical entry | | |
| (11)-7 | Program | Inter-Ch Op. | Off, On | | |
| | | Operation | CH-X (Function) CH-Y CH-X : CH1 to CH112 Function : Four arithmetic operations (+, -, ×, ÷) CH-Y : CH1 to CH112 | | |
| | | | Scaling | /1000000, 1000, ×1, ×1000, ×1000000 | |
| | Span | Upper level | -100000 to +100000 (Numerical entry) | | |
| | | Lower level | -100000 to +100000 (Numerical entry) | | |
| | | Decimal point | +1.0000, +10.000, +100.00, +1000.0, +10000 | | |
| | Select Unit | Categories | Current, Length, Area, Volume, Acceleration, Frequency, Mass, Energy, Pressure, Flow, Temperature | | |
| | | Unit selection | (Item selection changes depending on the groups mentioned above) | | |
| Unit | The above unit selection result or character entry | | | | |
| (11)-8 | Misc | Waveform color setting | Red, Green, Blue (RGB) Each color 0 to 31 | | |
| | | Thickness setting | 1 to 8dots | | |
| | | Perform auto zero ADJ. | ▷ Execute | | |
| | | Reset auto zero ADJ. | ▷ Execute | | |

<Voltage/Temperature Module (GL7-M)>

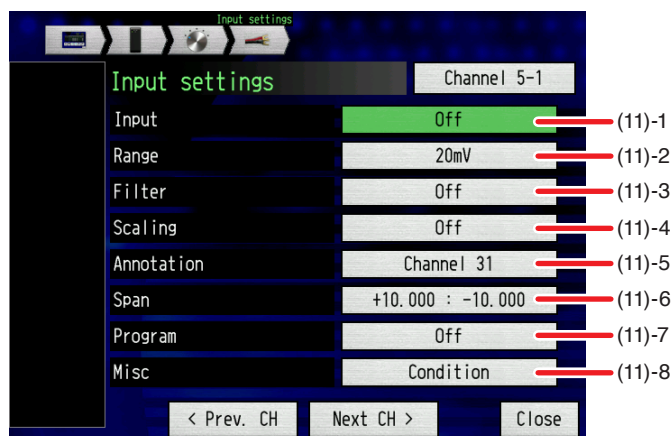

| Item select | | Examples of item | | | |
|-------------|----------------|--|---|---|--------------------------------------|
| (11)-1 | Input | Off, DC, TEMP, RH | | | |
| (11)-2 | Range | DC | 20/50/100/200/500mV, 1/2/5/10/20/50V, 1-5V | | |
| | | TEMP | TC-K, TC-J, TC-T, TC-R, TC-E, TC-B, TC-S, TC-N, TC-W, Pt100, JPT100, Pt1000 | | |
| (11)-3 | Filter | Off, 2 to 5, 10, 20, 40 | | | |
| (11)-4 | Scaling | [Voltage] | Scaling | Off, On | |
| | | Meas. Value | Upper limit value | Numerical entry | |
| | | | Lower limit value | Numerical entry | |
| | | Scal. Value | Upper limit value | Numerical entry | |
| | | | Lower limit value | Numerical entry | |
| | | Decimal point | | +1.0000, +10.000, +100.00, +1000.0, +10000 | |
| | | Select | Categories | Current, Length, Area, Volume, Acceleration, Frequency, Mass, Energy, Pressure, Flow, Temperature, Strain | |
| | | | Unit selection | (Item selection changes depending on the groups mentioned above) | |
| | | Unit | | The above unit selection result or character entry | |
| | | [Temperature] | Scaling | | Off, On |
| | | | Adjust | Meas. Value | Numerical entry |
| | | | | Scal. Value | Numerical entry |
| | | | Read current | | Reflects the current measured values |
| Select | Categories | | Current, Length, Area, Volume, Acceleration, Frequency, Mass, Energy, Pressure, Flow, Temperature, Strain | | |
| | Unit selection | | (Item selection changes depending on the groups mentioned above) | | |
| Unit | | | The above unit selection result or character entry | | |
| (11)-5 | Annotation | Text input (up to 31 characters) | | | |
| (11)-6 | Span | Upper limit value | Numerical entry | | |
| | | Lower limit value | Numerical entry | | |
| (11)-7 | Program | Inter-Ch Op. | | Off, On | |
| | | Operation | | CH-X (Function) CH-Y CH-X : CH1 to CH12 Function: Four arithmetic operations (+, -, ×, ÷) CH-Y : CH1 to CH12 | |
| | | Scaling | | /1000000, /1000, ×1, ×1000, ×1000000 | |
| | | Span | Upper level | -100000 to +100000 (Enter a number) | |
| | | | Lower level | -100000 to +100000 (Enter a number) | |
| | | | Decimal point | +1.0000, +10.000, +100.00, +1000.0, +10000 | |
| | | Select Unit | Categories | Current, Length, Area, Volume, Acceleration, Frequency, Mass, Energy, Pressure, Flow, Temperature | |
| | | | Unit selection | (Item selection changes depending on the groups mentioned above) | |
| Unit | | The above unit selection result or character entry | | | |
| (11)-8 | Misc | Waveform color setting | | Red, Green, Blue (RGB) Each color 0 to 31 | |
| | | Thickness setting | | 1 to 8dots | |
| | | Perform auto zero ADJ. | | ▷ Execute | |
| | | Reset auto zero ADJ. | | ▷ Execute | |
| | | | | | |

* Pt1000: IEC751 compatible

<High Speed Voltage Module (GL7-HSV)>

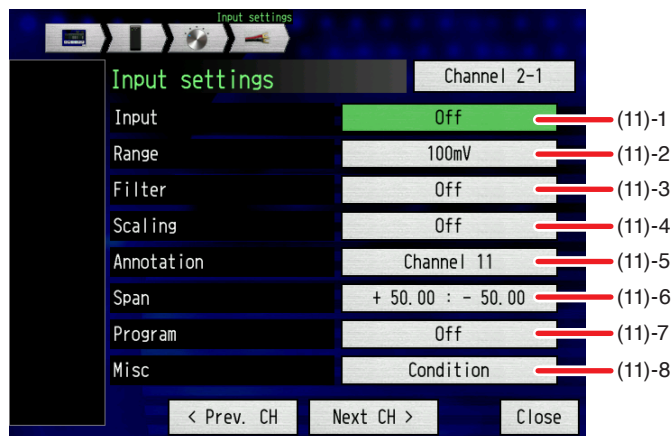

| Item select | | Examples of item | | |
|----------------|--|--|---|---|
| (11)-1 | Input | Off, DC | | |
| (11)-2 | Range | 100/200/500mV, 1/2/5/10/20/50/100V, 1-5V | | |
| (11)-3 | Filter | Off, Line, 5/50/500Hz, 5/50kHz | | |
| (11)-4 | Scaling | Scaling | Off, On | |
| | | Meas. Value | Upper limit value | Numerical entry |
| | | | Lower limit value | Numerical entry |
| | | Scal. Value | Upper limit value | Numerical entry |
| | | | Lower limit value | Numerical entry |
| | | Decimal point | +1.0000, +10.000, +100.00, +1000.0, +10000 | |
| | | Select | Categories | Current, Length, Area, Volume, Acceleration, Frequency, Mass, Energy, Pressure, Flow, Temperature, Strain |
| Unit selection | (Item selection changes depending on the groups mentioned above) | | | |
| Unit | | The above unit selection result or character entry | | |
| (11)-5 | Annotation | Text input (up to 31 characters) | | |
| (11)-6 | Span | Upper limit value | Numerical entry | |
| | | Lower limit value | Numerical entry | |
| (11)-7 | Program | Inter-Ch Op. | Off, On | |
| | | Operation | CH-X (Function) CH-Y CH-X: CH1 to CH12 Function: Four arithmetic operations (+, -, ×, ÷) CH-Y: CH1 to CH12 | |
| | Scaling | /1000000, /1000, ×1, ×1000, ×1000000 | | |
| | Span | Upper level | -100000 to +100000 (Numerical entry) | |
| | | Lower level | -100000 to +100000 (Numerical entry) | |
| | | Decimal point | +1.0000, +10.000, +100.00, +1000.0, +10000 | |
| | Select Unit | Categories | Current, Length, Area, Volume, Acceleration, Frequency, Mass, Energy, Pressure, Flow, Temperature, Strain | |
| Unit selection | | (Item selection changes depending on the groups mentioned above) | | |
| Unit | | The above unit selection result or character entry | | |
| (11)-8 | Misc | Waveform color setting | Red, Green, Blue (RGB) Each color 0 to 31 | |
| | | Thickness setting | 1 to 8dots | |
| | | Perform auto zero ADJ. | ▷ Execute | |
| | | Reset auto zero ADJ. | ▷ Execute | |

<Logic/Pulse Module (GL7-L/P)>

<When channel is set as logic>

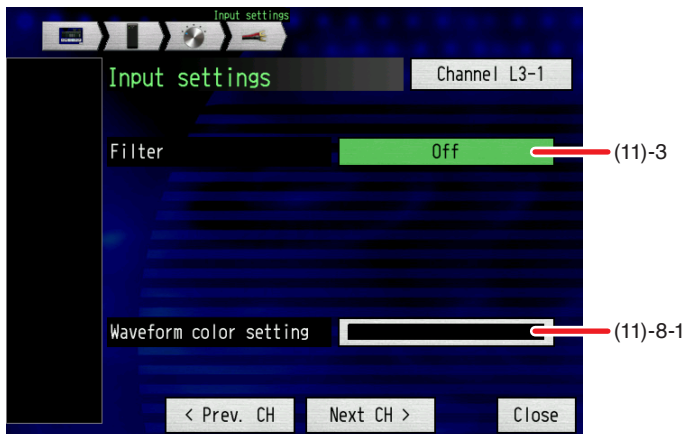

<When channel is set as pulse>

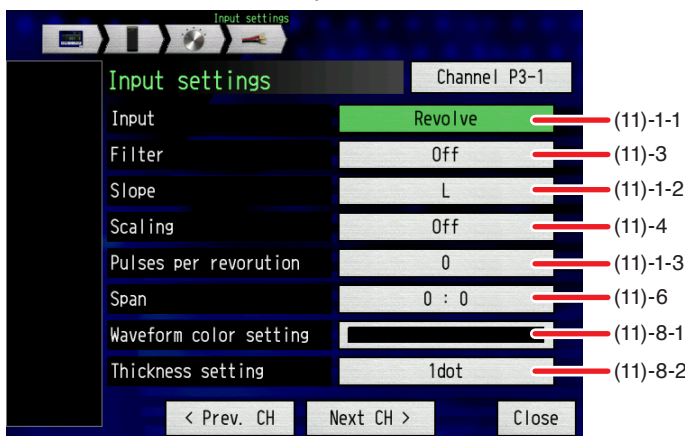

| Item select | | Examples of item | |
|-------------|---------------------------------|---|---|
| (11)-1-1 | Input | Off, Revolve, Counts, Instant | |
| (11)-1-2 | Slope | L, H | |
| (11)-1-3 | Number of pulses per revolution | Numerical entry (1 to 10000) | |
| (11)-3 | Filter | Off, On | |
| (11)-4 | Scaling | Scaling | Off, On |
| | | Meas. Value | Upper limit value Numerical entry |
| | | Scal. Value | Upper limit value Numerical entry |
| | | Select | Categories Current, Length, Area, Volume, Velocity, Acceleration, Frequency, Mass, Energy, Pressure, Flow, Temperature, Strain |
| | | Unit | Unit selection (Item selection changes depending on the groups mentioned above) |
| (11)-6 | Span | Upper limit value | Numerical entry |
| | | Lower limit value | Numerical entry |
| (11)-8-1 | Waveform color setting | Red, Green, Blue (RGB) Each color 0 to 31 | |
| (11)-8-2 | Thickness setting | 1 to 8dots | |

CHECKPOINT

- To switch between the Logic and Pulse, touch the "Pulse/Logic" select button on the Channel setting screen ("Home" → (Each Amplifier Module) → "Channel settings")
- If multiple Logic/Pulse modules (GL7-LP) are installed and the switching between the Logic and Pulse is performed, please note that since the internal channel number setting is modified, the setting conditions of Logic/Pulse module are changed.

<High-voltage Module (GL7-HV)>

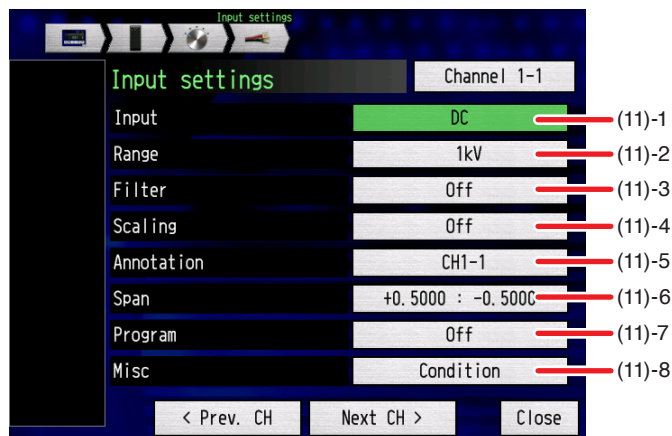

| Item select | | Examples of item | | |
|----------------|--|--|---|---|
| (11)-1 | Input | Off, DC, AC, DC-RMS, AC-RMS | | |
| (11)-2 | Range | DC, AC : 2, 5, 10, 20, 50, 100, 200, 500, 1000 V F.S. DC-RMS, AC-RMS: 1, 2, 5, 10, 20, 50, 100, 200, 500 V F.S. | | |
| (11)-3 | Filter | Off, Line, 5/50/500Hz, 5/50kHz | | |
| (11)-4 | Scaling | Scaling | Off, On | |
| | | Meas. Value | Upper limit value | Numerical entry |
| | | | Lower limit value | Numerical entry |
| | | Scal. Value | Upper limit value | Numerical entry |
| | | | Lower limit value | Numerical entry |
| | | Decimal point | +1.0000, +10.000, +100.00, +1000.0, +10000 | |
| | | Select | Categories | Current, Length, Area, Volume, Acceleration, Frequency, Mass, Energy, Pressure, Flow, Temperature, Strain |
| Unit selection | (Item selection changes depending on the groups mentioned above) | | | |
| Unit | | The above unit selection result or character entry | | |
| (11)-5 | Annotation | Text input (up to 31 characters) | | |
| (11)-6 | Span | Upper limit value | Numerical entry | |
| | | Lower limit value | Numerical entry | |
| (11)-7 | Program | Inter-Ch Op. | Off, On | |
| | | Operation | CH-X (Function) CH-Y CH-X: CH1 to CH112 Function: Four arithmetic operations (+, -, ×, ÷) CH-Y: CH1 to CH112 | |
| | Scaling | /1000000, /1000, ×1, ×1000, ×1000000 | | |
| | Span | Upper level | -100000 to +100000 (Numerical entry) | |
| | | Lower level | -100000 to +100000 (Numerical entry) | |
| | | Decimal point | +1.0000, +10.000, +100.00, +1000.0, +10000 | |
| | Select Unit | Categories | Current, Length, Area, Volume, Acceleration, Frequency, Mass, Energy, Pressure, Flow, Temperature, Strain | |
| Unit selection | | (Item selection changes depending on the groups mentioned above) | | |
| Unit | | The above unit selection result or character entry | | |
| (11)-8 | Misc | Waveform color setting | Red, Green, Blue (RGB) Each color 0 to 31 | |
| | | Thickness setting | 1 to 8dots | |
| | | Perform auto zero ADJ. | ▷ Execute | |
| | | Reset auto zero ADJ. | ▷ Execute | |

<DC Strain Module (GL7-DCB)>

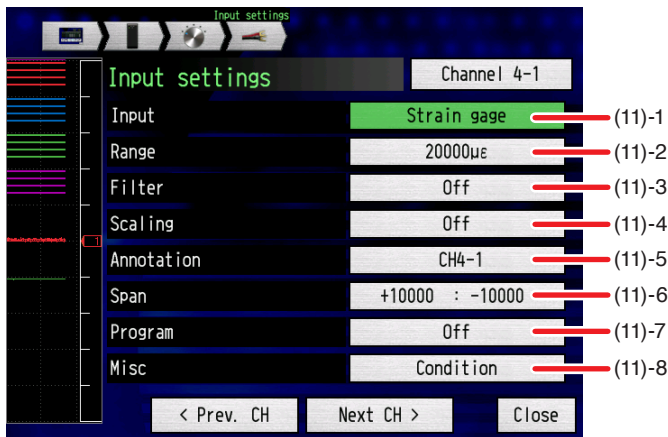

| | | Item select | | Examples of selection | | |
|------------------|-----------|--|--|--|--|------------------------------------|
| (11)-1 | Input | Input | | Off, Strain gauge, Strain sensor, Voltage, Resistance | | |
| | | Strain gauge *1 | Bridge type | | Quarter bridge, Half bridge, Full bridge | |
| | | | Number of wires | | 2 wires, 3 wires, 4 wires, 5 wires, 6 wires | |
| | | | Gauge resistor | Quarter, Half bridge | | 120Ω, 350Ω |
| | | | | Full bridge | | Enter the number. |
| | | | Polarity inverse | | On, Off | |
| | | Strain sensor *2 | Number of wires | | 4 wires, 6 wires | |
| | | | Bridge resistor | | Enter the number. | |
| | | | TEDS settings *3 | Read TEDS information | | ▷ Read |
| | | | | Release TEDS information | | ▷ Release |
| | | | | Save TEDS information | File name | Enter the characters. |
| | | | | | Naming | Automatic, Optional, Serial number |
| | | | Read TEDS information | File name | Select the file. | |
| | | Read | | ▷ Execute | | |
| Polarity inverse | | On, Off | | | | |
| Voltage | | - | | | | |
| Resistance | | - | | | | |
| (11)-2 | Range | Strain gauge /Strain sensor | Strain unit | µε | 400, 500, 800, 1000, 2000, 4000, 5000, 8000, 10000, 20000 µε (µε: 10 ⁻⁶ Strain) * The range depends on the bridge voltage. | |
| | | | | mV/V | 0.2, 0.25, 0.4, 0.5, 1, 2, 2.5, 4, 5, 10 mV/V | |
| | | Voltage | | 1, 2, 5, 10, 20, 50, 100, 200, 500 mV, 1, 2, 5 V | | |
| | | Resistance *4 | | 1, 2, 5, 10, 20, 50, 100, 200, 500 Ω, 1, 2, 5, 10, 20, 50 kΩ | | |
| (11)-3 | Filter | L.P.F | | Off, Line (1.5Hz) 3, 6, 10, 30, 50, 60, 100. 300, 500Hz, 1, 3, 5, 10kHz, Automatic (A.A.F) | | |
| (11)-4 | Scaling | Scaling | | Off, On | | |
| | | Meas. Value | Upper limit value | Enter the number. | | |
| | | | Lower limit value | Enter the number. | | |
| | | Output Value | Upper limit value | Enter the number. | | |
| | | | Lower limit value | Enter the number. | | |
| | | Decimal point | | Select the decimal point value according to the range. | | |
| | | Unit selection | Sorting | | Current, length, area, volume, velocity, acceleration, frequency, weight, job, pressure, flow rate, temperature, strain | |
| Unit selection | | | (Selected items vary depend on the group above.) | | | |
| Unit | | Enter the characters. | | | | |
| (11)-5 | Annotatio | Enter the characters. (Max. 31 characters) | | | | |

| | | Item select | | | Examples of selection | | |
|--------------------|---------------------------------|--------------------------|--|-------------------------|---|---|---|
| (11)-6 | Span | Upper level | | | Enter the number. | | |
| | | Lower level | | | Enter the number. | | |
| (11)-7 | Program | Program | | | Off, On | | |
| | | Arithmetic expression | | | CH-X (Function) CH-Y CH-X: CH1 to CH112 Function: four arithmetic operations (+, -, x, ÷) CH-Y: CH1 to CH112 | | |
| | | Scaling | | | /1000000, /1000, x1, x1000, x1000000 | | |
| | | Calculation span | Upper limit value | | Enter the number. | | |
| | | | Lower limit value | | Enter the number. | | |
| | | | | Decimal point | | Select the decimal point value according to the range. | |
| | | Unit selection | Sorting | | | Current, length, area, volume, velocity, acceleration, frequency, weight, job, pressure, flow rate, temperature, strain | |
| Unit selection | | | (Selected items vary depend on the group above.) | | | | |
| | | Unit | | | Enter the characters. | | |
| (11)-8 | Misc | Common | Waveform color settings | | | Red, Green, Blue (RGB) Each color: 0 to 31 | |
| | | | Thickness settings | | | 1 to 8 dots | |
| | | Strain gauge | Auto balance adjustment | | | ▷ Execute | |
| | | | Shunt calibration*5 | | | ▷ Execute | |
| | | | Sensor setting *1 | Bridge power | Quarter, Half bridge | Voltage | Voltage clamp |
| | | | | | Full bridge | Voltage | Resistance |
| | | | | Bridge voltage | Quarter, Half, Full bridge | Voltage | 1, 2, 2.5, 5, 10V |
| | | | Full bridge | | Constant current | Target bridge voltage 1, 2, 2.5, 5, 10V (Display the calculation of gauge resistance value amd current value) | |
| | | | Strain unit | | | µε, mV/V | |
| | | Strain sensor | Auto balance adjustment | | | ▷ Execute | |
| | | | Sensor setting | Bridge voltage | | 1, 2, 2.5, 5, 10V | |
| | | | | Rated output | | Enter the number. | |
| | | | | Calibration coefficient | | Enter the number. | |
| | | | Unit selection | Sorting | | | Current, length, area, volume, velocity, acceleration, frequency, weight, job, pressure, flow rate, temperature, strain |
| | | | | Unit selection | | | (Selected items vary depend on the group above.) |
| | | | Unit | | | Enter the characters. | |
| | | | TEDS settings Same function as *3 | Read TEDS information | | ▷ Read | |
| | | Release TEDS information | | ▷ Release | | | |
| | | Save TEDS information | | File name | Enter the characters. | | |
| | | | | Naming | Automatic, Optional, Serial number | | |
| | | Read TEDS information | | File name | Select the file. | | |
| | | | | Read | ▷ Execute | | |
| | | Strain unit | | | µε, mV/V | | |
| Voltage/Resistance | Automatic zero point adjustment | | | ▷ Execute | | | |
| | zero point adjustment limit | | | ▷ Reset | | | |

* For the supplement description of the mark (*), refer to the below.

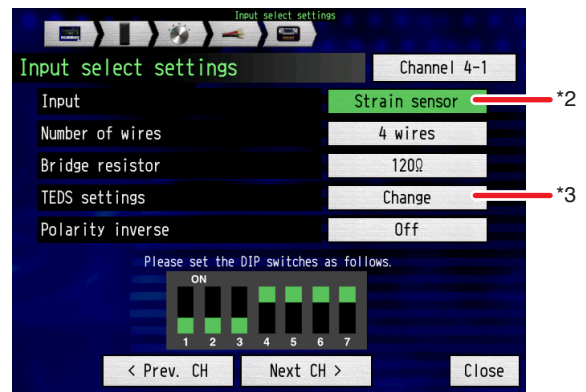
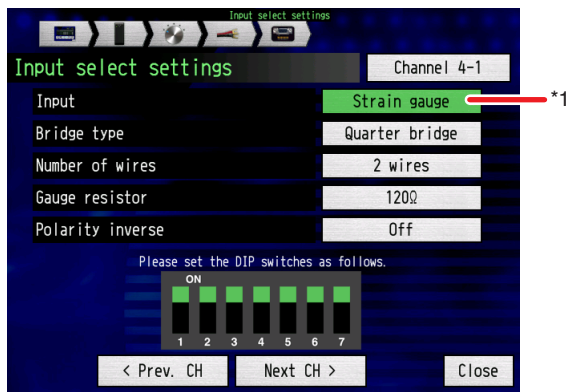

***1: How to use the DC strain module**

The section explains how to connect the DC strain module.

<Setting procedure>

- Refer to "Chapter 2 Confirmation and preparation of the DC strain module" to wire between the DC strain module and input terminals.
- Select the DC strain module in the Input select settings of the Input Selecting screen.
- Select one of Quarter bridge, Half bridge or Full bridge as Bridge type.
- Next, select Number of wires. Number of wires depends on the Bridge type. Number of wires should be set depending on the type.
- Select the either 120Ω or 350Ω as Gauge resistor when Quarter bridge or Half bridge is used.
- When the Full bridge is used, enter the value.
- From Misc in the input settings menu (10)-8, select the bridge voltage in the sensor settings.

⚠ WARNING

The bridge voltage 5V and 10V only should be used for the 350Ω gauge resistor. When the 350Ω gauge resistor is set, the module or gauge may be damaged.

⚠ CAUTION

When using Full bridge, the resistance value is limited depending on the settings of bridge voltage.

[Strain gauge]

Setting range of the gauge resistor

| | Bridge voltage | Bridge current | Gauge type | | | |
|----------------|----------------|----------------|-------------|------|--------------|----------------|
| | | | Full bridge | | Half bridge | Quarter bridge |
| | | | Max. | Max. | | |
| Gauge resistor | 1 V | Voltage | 1000 Ω | 50 Ω | 120 or 350 Ω | |
| | | Current | | 50 Ω | | |
| | 2 V | Voltage | 95 Ω | | | |
| | | Current | 100 Ω | | | |
| | 2.5 V | Voltage | 114 Ω | | | |
| | | Current | 120 Ω | | | |
| | 5 V | Voltage | 330 Ω | | | |
| | | Current | 250 Ω | | | |
| 10 V | Voltage | 330 Ω | | | | |
| | Current | 500 Ω | | | | |

- Set the DIP switch on the module to the settings as shown at the bottom of the screen.
- The strain gauge can be set in the settings above. Simultaneously set the Range, Filter, Scaling, etc for the measurement.

- Before starting the measurement, perform the zero point adjustment by pressing the auto balance adjustment in Misc or the auto balance switch on the module.

* When performing the shunt calibration to correct the error in the strain gauge, refer to *5 Shunt calibration described below.

As well, if you do not know how to use remote sensing to correct the lead wire resistance, refer to the descriptions of the strain and bridge circuit configuration in Chapter 2 Confirmation and preparation of the DC strain module, and *5 Table listed the settable items.

***2: How to use the DC strain module**

The section explains how to connect the acceleration sensor and load cell, etc. to be used.

<Setting procedure>

- For how to connect the strain sensor, refer to Chapter 2 Confirmation and preparation of the DC strain module.
- Select the strain sensor in the Input select settings of the Input Selecting screen.
- Select the either 4 wires or 6 wires as Number of wires of the DC strain module.
- Enter the value of the bridge resistor in the DC strain module.
- Select the bridge voltage in the sensor setting of Misc.

⚠ WARNING

The bridge voltage 5V and 10V only should be used for the 350Ω gauge resistor. When the 350Ω gauge resistor is set the module or gauge may be damaged.

[Strain sensor]

Setting range of the Bridge resistor

| | Bridge voltage | Bridge current | Max. | Min. |
|-----------------|----------------|----------------|--------|-------|
| Bridge resistor | 1 V | Voltage | 1000 Ω | 50 Ω |
| | | Current | | 50 Ω |
| | 2 V | Voltage | | 95 Ω |
| | | Current | | 100 Ω |
| | 2.5 V | Voltage | | 114 Ω |
| | | Current | | 120 Ω |
| | 5 V | Voltage | | 330 Ω |
| | | Current | | 250 Ω |
| | 10 V | Voltage | | 330 Ω |
| | | Current | | 500 Ω |

- Enter the value of the rated output of the DC strain module to be used. The unit is μV/V.
 - Enter the value of the calibration coefficient of the DC strain module to be used.
 - Select the unit depending on the type of DC strain module.
 - The strain sensor can be set in the settings above. Simultaneously set the Range, Filter, Scaling, etc. for the measurement.
 - Before starting the measurement, set the initial value to 0 (zero) by performing the auto balance adjustment in the Misc or pressing the auto-balancing switch on the module.
- * Refer to *3 below, when the sensor with TEDS function is used.

***3: The section explains how to use the sensor with TEDS function.**

When the TEDS-compatible sensor is used, the information of rating capacity, rated output and unit are automatically read in the module.

The TEDS function of this module complies with IEEE1451.4 standard template No.33 (Strain sensor). TEDS function can be set in "Input select settings" or "Misc".

<Setting procedure>

- The strain sensor is connected using the DSUB-NDIS conversion cable (B-561) supplied. (Only the cable sold in Japan) One DSUB-NDIS conversion cable only is supplied. If not enough, please buy the optional accessories separately.
When the other connector not manufactured by Tajimi is used, connect a DSUB connector or via a DSUB-Screw terminals conversion connector.
- In TEDS settings in the screen, get the "Read TEDS information".
Perform various settings of this module of strain sensor in this setting.
- Set the Range, Filter and Scaling, etc. depending on the measurement conditions after getting it.
- Set the DIP switch as the settings of DIP switch displayed at the bottom of the Input Select Setting screen.
- The connection settings are completed.

⚠ CAUTION

Since the NDIS connector has no remote sensing terminals, if the wiring between this module and the strain sensor is longer, the accuracy may be adversely affected.

***4: Resistance range provides the following functions.**

When the resistance range is set, the exciting current is automatically set the current value as shown the table below.

| Range | Exciting current |
|-------|------------------|
| 1Ω | 10 mA |
| 2Ω | |
| 5Ω | |
| 10Ω | |
| 20Ω | |
| 50Ω | 1 mA |
| 100Ω | |
| 200Ω | |
| 500Ω | |
| 1kΩ | |
| 2kΩ | |
| 5kΩ | 0.1 mA |
| 10kΩ | |
| 20kΩ | |
| 50kΩ | |

***5: Shunt calibration:**

When the shunt resistor (approx. 60kΩ: at 120Ω, approx. 175kΩ: at 350Ω) built in this module and the strain gauge to be used are connected in parallel, the error in the measurement range is reduced by correcting (calibrating) automatically. Therefore, the measurement accuracy will be enhanced.

<Setting procedure>

- Connect the strain gauge depending on the application.
- In Input select settings on the screen, arrange the Bridge type, Number of wires, and Gauge resistor in the input items.
- Set the DIP switch as the settings of DIP switch displayed at the bottom of the Input Select Setting screen.
- Perform the shunt calibration of setting items in Misc.
Calibration is completed.
- Before starting the measurement, make sure to perform the zero point correction by pressing the auto-balancing in Misc or the module.

CAUTION

- When the measurement conditions are changed, make sure to perform the shunt calibration again.
- When the power cycle is performed, the setting values are initialized. For this reason, make sure to perform the shunt calibration again.
- The following table shows the possible settings for the remote sensing and shunt calibration.

| Input | Bridge type | Number of wires | Remote sensing | Shunt calibration |
|---------------|------------------------|-----------------|----------------|-------------------|
| Strain gauge | Quarter bridge | 2 wires | Disable | Disable |
| | | 3 wires | Enable | Enable |
| | | 4 wires | Enable | Enable |
| | Half bridge | 3 wires | Disable | Disable |
| | | 4 wires | Enable | Disable |
| | | 5 wires | Enable | Enable |
| Full bridge | 4 wires | Disable | Disable | |
| | 6 wires | Enable | Disable | |
| Strain sensor | without remote Sensing | 4 wires | Disable | Disable |
| | with remote Sensing | 6 wires | Enable | Disable |

CHECKPOINT

There are the following methods in order to improve the measurement precision of the strain gauge and strain gauge-type conversion sensor.

1. Gauge factor correction

In the strain gauge measurement with the GL7-DCB (DC strain module), the strain is calculated as gauge factor 2.0. If the gauge factor of the strain gauge used to measure is not 2.0, the true strain can be calculated using the following equation.

$$\text{True strain } (\epsilon) = \frac{2.00}{\text{Gauge factor (Ks)}} \times \text{Measured strain } (\epsilon)$$

2. How to measure depending on the changes in environmental temperature at the measurement.

(1) In addition to the strain caused by external force, the apparent strain is caused by the linear expansion coefficients of the material of the object to be measured by a temperature change and the strain gauge (Resistive element). When the self-temperature-compensated gauge to correct the linear expansion coefficient of the object to be measured is used, the influence of apparent strain caused by the difference in the linear expansion coefficient is eliminated.

(2) If the distribution cable is longer or the measurement environment temperature significantly changes, the resistance change caused by the change of the cable conductor resistance is measured as the apparent strain. There are the following two methods to eliminate the effects of the error.

(2)-1. Remote sensing function (Use of remote sensing terminals)

With the remote sensing function, the change of the cable conductor resistance that causes the error can be prevented.

When the strain gauge measurement with Quarter bridge, Half bridge or Full bridge is used, or the remote sensing terminals are additionally wired for the strain transducer sensor, the voltage drop caused by the cable conductor resistance from the module to the object to be measured can be prevented and the regulated voltage is applied.

(2)-2. Use of the constant-current system

When the remote sensing function is not available because that additional cable wiring is difficult for the measurement with the strain transducer sensor, select the constant-current system. Enter the value of the input resistance (R) of the strain transducer sensor bridge circuit and select one of 1, 2, 2.5, 5 or 10V as the exciting voltage (E) of the bridge circuit. As a result, you can control the constant current to generate a regulated voltage that satisfies the following equation.

Exciting voltage (E) of the bridge circuit = Input resistance (R) of the bridge circuit x Constant current (I)

Therefore, when the constant-current system is selected, the voltage drop caused by the cable conductor resistance can be prevented and the regulated voltage is supplied to the strain transducer sensor.

<Charge Module (GL7-CHA)>

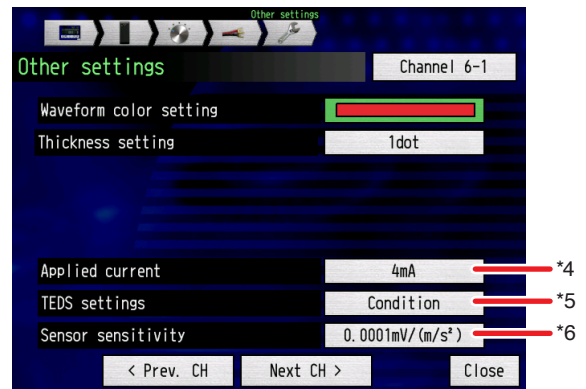
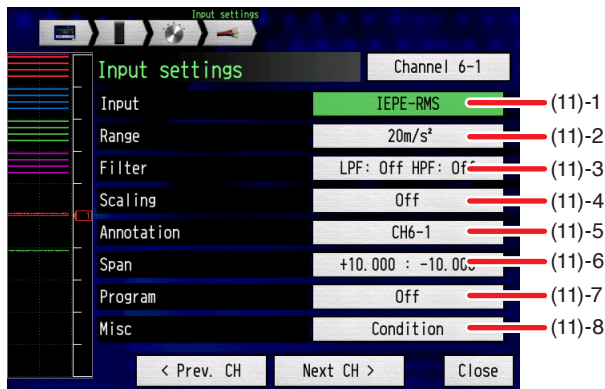

| Setting items | | Examples of selection | | |
|---------------|--------------------------------------|--|---|---|
| (11)-1 | Input | Off, Charge, IEPE, DC, AC, Charge-RMS, IEPE-RMS, DC -RMS, AC-RMS | | |
| (11)-2 | Range | Charge | 5, 10, 20, 50, 100, 200, 500, 1000, 2000, 5000, 10000, 20000, 50000m/s ² | |
| | | IEPE | 1, 2, 5, 10, 20, 50, 100, 200, 500, 1000, 2000, 5000, 10000, 20000, 50000m/s ² | |
| | | DC | 50, 100, 200, 500mV, 1, 2, 5, 10V | |
| | | AC | 50, 100, 200, 500mV, 1, 2, 5, 10V | |
| | | Charge-RMS *1 | 5, 10, 20, 50, 100, 200, 500, 1000, 2000, 5000, 10000, 20000, 50000m/s ² | |
| | | IEPE-RMS *1 | 1, 2, 5, 10, 20, 50, 100, 200, 500, 1000, 2000, 5000, 10000, 20000, 50000m/s ² | |
| | | DC-RMS *1 | 20, 50, 100, 200, 500mV, 1, 2, 5V | |
| | | AC-RMS *1 | 20, 50, 100, 200, 500mV, 1, 2, 5V | |
| (11)-3 | Filter | L. P. F *2 | Off, Line (1.5Hz), 3, 6, 10, 30, 50, 60, 100, 300, 500Hz, 1, 3, 5, 10kHz, Automatic (A.A.F) | |
| | | H. P. F *3 | Off, 0.15, 1, 10Hz | |
| (11)-4 | Scaling | Scaling | Off, On | |
| | | Meas. Value | Upper limit value | Enter the number. |
| | | | Lower limit value | Enter the number. |
| | | Output Value | Upper limit value | Enter the number. |
| | | | Lower limit value | Enter the number. |
| | | Decimal point | Select the decimal point value depending on the range. | |
| | | Unit selection | Sorting | Current, length, area, volume, velocity, acceleration, frequency, weight, job, pressure, flow rate, temperature, strain |
| | | | Unit selection | (Selected items vary depend on the group above.) |
| Unit | Enter the characters. | | | |
| Integral *4 | Acceleration, velocity, displacement | | | |
| (11)-5 | Annotation | Enter the characters. (Max. 31 characters) | | |
| (11)-6 | Span | Upper limit value | Enter the number. | |
| | | Lower limit value | Enter the number. | |
| (11)-7 | Program | Program | Off, On | |
| | | Arithmetic expression | CH-X (Function) CH-Y CH-X: CH1 to CH12 Function: four arithmetic operations (+, -, x, ÷) CH-Y: CH1 to CH12 | |
| | Scaling | /1000000, /1000, ×1, ×1000, ×1000000 | | |
| | Calculation span | Upper limit value | Enter the number. | |
| | | Lower limit value | Enter the number. | |
| | | Decimal point | Select the decimal point value depending on the range. | |
| | Unit selection | Sorting | Current, length, area, volume, velocity, acceleration, frequency, weight, job, pressure, flow rate, temperature, strain | |
| | | Unit selection | (Selected items vary depend on the group above.) | |
| Unit | Enter the characters. | | | |

| Setting items | | Examples of selection | | | |
|-----------------|-----------------------|-------------------------|--|--|------------------------------------|
| (11)-8 | Misc | DC, AC, DC-RMS, AC-RMS | Waveform color settings | Red, Green, Blue (RGB) Each color: 0 to 31 | |
| | | | Thickness settings | 1 to 8 dots | |
| | | | Automatic zero point adjustment | ▷ Execute | |
| | | | Zero point adjustment reset | ▷ Execute | |
| | IEPE, IEPE-RMS | | Waveform color settings | Red, Green, Blue (RGB) Each color: 0 to 31 | |
| | | | Thickness settings | 1 to 8 dots | |
| | | | Applied current | 4, 8mA | |
| | | | TEDS settings *5 | Read TEDS information | ▷ Execute |
| | | | | Release TEDS information | ▷ Execute |
| | | | Save TEDS information | File name | Enter the characters. |
| | | | | Naming | Automatic, Optional, Serial number |
| | | | | Save | ▷ Execute |
| | | | Save TEDS information | File name | Select the file. |
| | | | | Read | ▷ Execute |
| | Sensor sensitivity *1 | | Enter the number. (Value of the sensor to be used) | | |
| Charge, Charge- | | Waveform color settings | Red, Green, Blue (RGB) Each color: 0 to 31 | | |
| | | Thickness settings | 1 to 8 dots | | |
| | | Sensor sensitivity *1 | Enter the number. (Value of the sensor to be used) | | |

- *1: Range: Within 2Vrms range; Crest Factor 4 or less, 5Vrms range; Crest Factor 2 or less
- *2: Filter: A. A. F. (Anti-aliasing filter) is automatically set to 1/2.5 of the sampling frequency. Also, A.A.F. and L.P.F. can not be used together.
- *3: When the input coupling is AC or AC-RMS and "AC" is displayed, H. P. F is not available.
- *4: Integral: The output of the acceleration sensor can be set to one of Acceleration, Velocity or Displacement.

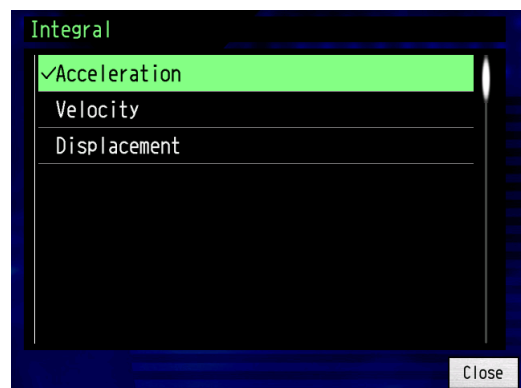
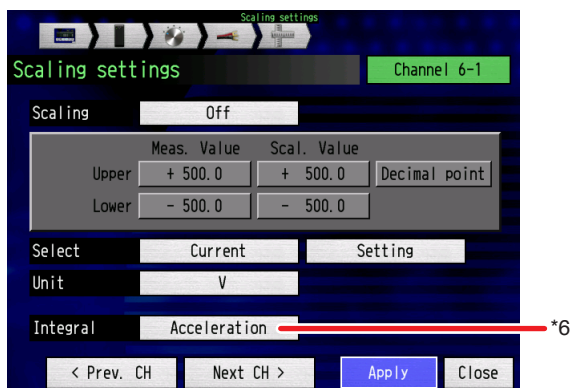

- When the Integral is set to Velocity or Displacement, the scaling value is automatically set. The scaling value is not allowed to change.
- The velocity can be converted within the range of 10 to 180Hz.
- The displacement can be converted within the range of 10 to 60Hz.

- *5: Applied current: This is used for the range settings of Built-in amplifier, Built-in amplifier-RMS.
- *6: TEDS settings: When the TEDS-compatible sensor is used, the information of the rated capacity and rated output is automatically read in the this module. The TEDS function of this module conforms to IEEEE1451.4 Template ID25 (Acceleration sensor). For the settings, refer to the following setting procedure.
- *7: Built-in amplifier: When the built-in amplifier is installed, the H.P.F. (1Hz) is automatically set.
- *8: Charge: Such as when the zero point is shifted, the H.P.F. should be installed as necessary.

<Setting procedure>

- Connect the acceleration sensor with built-in amplifier to the BNC terminal.
- In Input Select settings on the screen, match the input value to the range of Built-in amplifier or Built-in amplifier-RMS.
- In TEDS settings in the screen, perform the Read TEDS information. Various settings of this module connected the acceleration sensor are completed in this setting.
- The acceleration sensor can be set using the setting procedure above. Set the range modification, filter and scaling, etc. in accordance with the measurement conditions.

The connection settings are completed.

How to use the acceleration sensor

This section explains how to connect the acceleration sensor with built-in preamplifier.

<Setting procedure>

- Set the input items of the IEPE or IEPE-RMS.
- Set "Sensor sensitivity in Misc" depending on the specifications of the sensor with sensor sensitivity.
- Set the Range.
Refer to the range setting table [IEPE/IEPE-RMS Input]. Selection of the voltage sensitivity varies depending on the range.
- Charge module is used as a unit. Therefore, set depending on "Integral in Scaling" when processing either the Velocity or Displacement.
- The acceleration sensor can be set in the settings above. Simultaneously set the Range, Filter, Scaling, etc for the measurement.

This section explains how to connect the charge-type acceleration sensor.

WARNING

When other than the sensor with built-in amplifier is set, do not change the input setting to Built-in amplifier, Built-in amplifier-RMS. This may damage the modules and the object to be measured.

<Setting procedure>

- Set the input items of the Charge or Charge-RMS.
- Set "Sensor sensitivity in Misc" depending on the specifications of the sensor with sensor sensitivity.
- Set the Range.
Refer to the range setting table [Charge/Charge-RMS Input]. Selection of the charge sensitivity varies depending on the range.
- When the velocity or displacement is processed for the acceleration sensor, set the processing method in "Scaling lintegral".
- When processing either the Velocity or Displacement for the acceleration sensor to be used, set the processing method depending on "Integral in Scaling".

(11)-1-1 Input

Selects the input conditions

<Voltage module>, <High-speed voltage module>

| Item select | Description |
|-------------|--|
| Off | Does not measure the input signal. Waveform, digital display also not carried out. |
| DC | For use when measuring input signal. |

<Voltage/Temperature module>

| Item select | Description |
|-------------|---|
| Off | Does not measure the input signal. Waveform, digital display also not carried out. |
| DC | For use when measuring voltage. |
| TEMP | For use when measuring the temperature. |
| Humidity | For use when using a B-530 humidity sensor to measure the humidity. In this case, the voltage range is set to 1V, and EU settings cannot be set. |

<Logic/Pulse module>

| Item select | Description |
|-------------|--|
| Off | Does not measure the input signal. Waveform, digital display also not carried out. |
| Revolve | Counts the number of pulses for each sample interval, and converts it to the rotation rate per minute. |
| Counts | The pulse of each sample interval is calculated from the measurement start and is recorded. |
| Instant | Records the number of pulses of each sample interval. |

* Can be selected when set to pulse amplifier.

CHECKPOINT

- When sampling rate is external, rotation rate can not be changed, and will become an instantaneous value. However the units will become RPM.
- When using a pulse, it will be at 0 at first. When start trigger is off, the first point of data is 0.

<High voltage module>

| Item select | Description |
|-------------|--|
| Off | Does not measure the input signal. Waveform, digital display also not carried out. |
| DC | The input signal is measured with DC coupling. |
| AC | The input signal is measured with AC coupling. |
| DC-RMS | The input signal is measured with DC coupling. The measured value is an effective value. |
| AC-RMS | The input signal is measured with AC coupling. The measured value is an effective value. |

<DC strain module>

| Item select | Description |
|---------------------|---|
| Off | The input signal is not measured. The waveforms and digital values are not displayed. |
| Strain gauge | This is used for Quarter bridge, Half bridge or Full bridge. |
| Strain gauge sensor | The sensor for Full bridge 4 wires and 6 wires is used to measure. |
| Voltage | This is used to measure the DC voltage. |
| Resistance | 1Ω to 50kΩ resistance is measured. |

<Charge module>

| Item select | Description |
|-------------|---|
| Off | The input signal is not measured. The waveforms and digital values are not displayed. |
| Charge | The acceleration sensor signal that conforms to the IEPE specification is measured. The measured value is an effective value. |
| IEPE | The acceleration sensor signal that conforms to the IEPE specification is measured. |
| DC | The input signal is measured with DC coupling. |
| AC | The input signal is measured with AC coupling. |
| Charge-RMS | The acceleration sensor signal that conforms to the charge specification is measured. The measured value is an effective value. |
| IEPE-RMS | The acceleration sensor signal that conforms to the charge specification is measured. |
| DC-RMS | The input signal is measured with DC coupling. The measured value is an effective value. |
| AC-RMS | The input signal is measured with AC coupling. The measured value is an effective value. |

(11)-1-2 Slope (Slope of the pulse)

Sets the pulse count slope (direction) when setting the pulse on a Logic/Pulse module.

| Item select | Description |
|-------------|--|
| L | Counts the falling edges of the pulse. |
| H | Counts the rising edges of the pulse. |

(11)-1-3 Number of pulses per revolution

When the input pulse is specified as the number of revolutions, set the number of pulses per revolution. As the number of pulses per revolution set here is 1 revolution, calculate the number of revolutions per minute (RPM).

For example, if "100" is set, 1 rotation is judged when 100 pulses have been input.

<Formula>

$$\text{Rotation (rpm)} = \text{Pulse input frequency} \div \text{Number of pulses per revolution} \times 60 \text{ (1min.)}$$

<Ex.>

Number of pulses per revolution : 100 (1 rotation is judged when 100 pulses have been input.)

Pulse entry : 1000 Hz (1000 pulses per sec.)

Number of revolutions : 600 RPM (600 RPM per min.)

(11)-2 Range

Selects the measurement range. The selectable contents changes according to the entry settings explained in the previous item (1)-1. Cannot be used when input is set to off.

<Voltage module>, <High-speed voltage module >

| Input settings | Selection |
|----------------|---|
| Voltage | 100 to 200/500mV, 1/2/5/10/20/50/100V, 1-5V |

| Range | Max. span (Measurable range) | Min. span | Min. resolution |
|--------|------------------------------|-----------|-----------------|
| 100 mV | -110.00 to +110.00 mV | 1.00 mV | 0.01 mV |
| 200 mV | -220.00 to +220.00 mV | 2.00 mV | 0.01 mV |
| 500 mV | -550.0 to +550.0 mV | 5.0 mV | 0.1 mV |
| 1 V | -1.1000 to +1.1000 V | 0.0100 V | 0.0001 V |
| 2 V | -2.2000 to +2.2000 V | 0.0200 V | 0.0001 V |
| 5 V | -5.500 to +5.500 V | 0.050 V | 0.001 V |
| 10 V | -11.000 to +11.000 V | 0.100 V | 0.001 V |
| 20 V | -22.000 to +22.000 V | 0.200 V | 0.001 V |
| 50 V | -55.00 to +55.00 V | 0.50 V | 0.01 V |
| 100 V | -110.00 to +110.00 V | 1.00 V | 0.01 V |

<Voltage/Temperature module>

| Input settings | Selection |
|----------------|---|
| Voltage | 20/50/100/200/500mV, 1/2/5/10/20/50V, 1-5V |
| Temperature | TC-K, TC-J, TC-T, TC-R, TC-E, TC-B, TC-S, TC-N, TC-W, Pt100, JPT100, Pt1000 |
| Humidity | No selection |

<Voltage>

| Range | Range max. span (Measurable range) | Min. span | Min. resolution |
|--------|------------------------------------|-----------|-----------------|
| 20 mV | -22.000 to +22.000 mV | 0.200 mV | 0.001 mV |
| 50 mV | -55.00 to +55.00 mV | 0.50 mV | 0.01 mV |
| 100 mV | -110.00 to +110.00 mV | 1.00 mV | 0.01 mV |
| 200 mV | -220.00 to +220.00 mV | 2.00 mV | 0.01 mV |
| 500 mV | -550.0 to +550.0 mV | 5.0 mV | 0.1 mV |
| 1 V | -1.1000 to +1.1000 V | 0.0100 V | 0.0001 V |
| 2 V | -2.2000 to +2.2000 V | 0.0200 V | 0.0001 V |
| 5 V | -5.500 to +5.500 V | 0.050 V | 0.001 V |
| 10 V | -11.000 to +11.000 V | 0.100 V | 0.001 V |
| 20 V | -22.000 to +22.000 V | 0.200 V | 0.001 V |
| 50 V | -55.00 to +55.00 V | 0.50 V | 0.01 V |

<Temperature>

| Range | Max. span | Min. span | Measurable range | Min. resolution |
|--------|-----------------|-----------|------------------|-----------------|
| TC-K | -270 to +2000°C | 50°C | -200 to +1370°C | 0.1°C |
| TC-J | | | -200 to +1100°C | |
| TC-T | | | -200 to +400°C | |
| TC-R | | | 0 to +1600°C | |
| TC-E | | | -200 to +800°C | |
| TC-B | | | +600 to +1820°C | |
| TC-S | | | 0 to +1760°C | |
| TC-N | | | -200 to +1300°C | |
| TC-W | | | 0 to +2000°C | |
| Pt100 | | | -200 to +850°C | |
| JPt100 | | | -200 to +500°C | |
| Pt1000 | | | -200 to +500°C | |

* Pt1000: Compliance with IEC 751

<Humidity>

| Range | Max. span | Min. span (p-p) | Min. resolution |
|-------|------------|-----------------|-----------------|
| – | 0 to +110% | 1.0% | 0.1% |

<High-voltage module>

| Input settings | Selection |
|----------------|--|
| DC | 2, 5, 10, 20, 50, 100, 200, 500, 1000 V |
| AC | 2, 5, 10, 20, 50, 100, 200, 500, 1000 V |
| DC-RMS | 1, 2, 5, 10, 20, 50, 100, 200, 500 V rms |
| AC-RMS | 1, 2, 5, 10, 20, 50, 100, 200, 500 V rms |

* The unit used in this module is V (volt).

[DC, AC]

| Range | Range max. span (Measurable range) | Min. span | Min. resolution |
|-------|------------------------------------|-----------|-----------------|
| 2 V | -2.2000 to +2.2000 V | 0.0200 V | 0.0001 V |
| 5 V | -5.500 to +5.500 V | 0.050 V | 0.001 V |
| 10 V | -11.000 to +11.000 V | 0.100 V | 0.001 V |
| 20 V | -22.000 to +22.000 V | 0.200 V | 0.001 V |
| 50 V | -55.00 to +55.00 V | 0.50 V | 0.01 V |
| 100 V | -110.00 to +110.00 V | 1.00 V | 0.01 V |
| 200 V | -220.00 to +220.00 V | 2.00 V | 0.01 V |
| 500 V | -550.0 to +550.0 V | 5.00 V | 0.1 V |
| 1 kV | -1.1000 to +1.1000 V | 0.0100 kV | 0.0001 kV |

[DC-RMS, AC-RMS]

| Range | Range max. span (Measurable range) | Min. span | Min. resolution |
|-----------|------------------------------------|--------------|-----------------|
| 1 V rms | 0 to +1.1000 V rms | 0.0100 V rms | 0.0001 V rms |
| 2 V rms | 0 to +2.2000 V rms | 0.0200 V rms | 0.0001 V rms |
| 5 V rms | 0 to +5.500 V rms | 0.050 V rms | 0.001 V rms |
| 10 V rms | 0 to +11.000 V rms | 0.100 V rms | 0.001 V rms |
| 20 V rms | 0 to +22.000 V rms | 0.200 V rms | 0.001 V rms |
| 50 V rms | 0 to +55.00 V rms | 0.50 V rms | 0.01 V rms |
| 100 V rms | 0 to +110.00 V rms | 1.00 V rms | 0.01 V rms |
| 200 V rms | 0 to +220.00 V rms | 2.00 V rms | 0.01 V rms |
| 500 V rms | 0 to +550.0 V rms | 5.00 V rms | 0.1 V rms |

* The unit used in this module is V (volt).

<DC strain module (GL7-DCB)>

[Strain gauge/Strain sensor]

| Input settings | Selection |
|----------------|---|
| $\mu\epsilon$ | 400, 500, 800, 1000, 2000, 4000, 5000, 8000, 10000, 20000 $\mu\epsilon$ |
| mV/V | 0.2, 0.25, 0.4, 0.5, 1, 2, 2.5, 4, 5, 10 mV/V |

The following table shows the span settings for the stain gauge.

| Range | Max. span | Min. span | Min. resolution |
|---------------------|--------------------------------|----------------------------------|--------------------|
| $\mu\epsilon$ | 400 $\mu\epsilon$ | -440.0 to +440.0 $\mu\epsilon$ | 4.0 $\mu\epsilon$ |
| | 500 $\mu\epsilon$ | -550.0 to +550.0 $\mu\epsilon$ | 5.0 $\mu\epsilon$ |
| | 800 $\mu\epsilon$ | -880 to +880 $\mu\epsilon$ | 8.0 $\mu\epsilon$ |
| | 1000 $\mu\epsilon$ | -11000 to +11000 $\mu\epsilon$ | 10.0 $\mu\epsilon$ |
| | 2000 $\mu\epsilon$ | -2200.0 to +2200.0 $\mu\epsilon$ | 20.0 $\mu\epsilon$ |
| | 4000 $\mu\epsilon$ | -4400.0 to +4400.0 $\mu\epsilon$ | 40.0 $\mu\epsilon$ |
| | 5000 $\mu\epsilon$ | -5500.0 to +5500.0 $\mu\epsilon$ | 50.0 $\mu\epsilon$ |
| | 8000 $\mu\epsilon$ | -8800.0 to +8800.0 $\mu\epsilon$ | 80.0 $\mu\epsilon$ |
| | 10000 $\mu\epsilon$ | -11000 to +11000 $\mu\epsilon$ | 100 $\mu\epsilon$ |
| 20000 $\mu\epsilon$ | -22000 to +22000 $\mu\epsilon$ | 200 $\mu\epsilon$ | |

| Range | | Max. span | Min. span | Min. resolution |
|-------|-----------|-------------------------|------------|-----------------|
| mV/V | 0.2 mV/V | -0.2200 to +0.2200 mV/V | 0.002 mV/V | 0.0001 mV/V |
| | 0.25 mV/V | -0.2750 to +0.2750 mV/V | 0.003 mV/V | 0.0001 mV/V |
| | 0.4 mV/V | -0.4400 to +0.4400 mV/V | 0.004 mV/V | 0.0001 mV/V |
| | 0.5 mV/V | -0.5500 to +0.5500 mV/V | 0.005 mV/V | 0.0001 mV/V |
| | 1 mV/V | -1.1000 to +1.1000 mV/V | 0.010 mV/V | 0.0001 mV/V |
| | 2 mV/V | -2.2000 to +2.2000 mV/V | 0.020 mV/V | 0.0001 mV/V |
| | 2.5 mV/V | -2.7500 to +2.7500 mV/V | 0.025 mV/V | 0.0001 mV/V |
| | 4 mV/V | -4.4000 to +4.4000 mV/V | 0.040 mV/V | 0.0001 mV/V |
| | 5 mV/V | -5.5000 to +5.5000 mV/V | 0.050 mV/V | 0.001 mV/V |
| | 10 mV/V | -11.000 to +11.000 mV/V | 0.100 mV/V | 0.001 mV/V |

When the strain sensor is used, the possible measuring range varies depending on the rated output and calibration coefficient.

[Voltage]

| Input settings | Selection |
|----------------|--|
| Voltage | 1, 2, 5, 10, 20, 50, 100, 200, 500 mV. 1, 2, 5 V |

| Range | | Max. span | Min. span | Min. resolution |
|---------|--------|-----------------------|-----------|-----------------|
| Voltage | 1 mV | -1.1000 to +1.1000 mV | 0.010 mV | 0.0001 mV |
| | 2 mV | -2.2000 to +2.2000 mV | 0.020 mV | 0.0001 mV |
| | 5 mV | -5.5000 to +5.5000 mV | 0.050 mV | 0.001 mV |
| | 10 mV | -11.000 to +11.000 mV | 0.100 mV | 0.001 mV |
| | 20 mV | -22.000 to +22.000 mV | 0.200 mV | 0.001 mV |
| | 50 mV | -55.00 to +55.00 mV | 0.50 mV | 0.01 mV |
| | 100 mV | -110.00 to +110.00 mV | 1.00 mV | 0.01 mV |
| | 200 mV | -220.00 to +220.00 mV | 2.00 mV | 0.01 mV |
| | 500 mV | -550.0 to +550.0 mV | 5.0 mV | 0.1 mV |
| | 1 V | -1.1000 to +1.1000 V | 0.0100 V | 0.0001 V |
| | 2 V | -2.2000 to +2.2000 V | 0.0200 V | 0.0001 V |
| | 5 V | -5.500 to +5.500 V | 0.050 V | 0.001 V |

[Resistance]

| Input settings | Selection |
|----------------|---|
| Resistance | 1, 2, 5, 10, 20, 25, 50, 100, 200, 500Ω, 1, 2, 5, 10, 20, 50 KΩ |

| Range | Range | | | Max. span | Min. span | Min. resolution |
|-------|------------------|------|------|-----------------------|-----------|-----------------|
| | Exciting current | 10mA | 1 mA | | | |
| 1 Ω | • | | | -1.1000 to +1.1000 Ω | 0.0100 Ω | 0.0001 Ω |
| 2 Ω | • | | | -2.2000 to +2.2000 Ω | 0.0200 Ω | 0.0001 Ω |
| 5 Ω | • | | | -5.5000 to +5.500 Ω | 0.050 Ω | 0.001 Ω |
| 10 Ω | • | | | -11.000 to +11.000 Ω | 0.100 Ω | 0.001 Ω |
| 20 Ω | • | | | -22.000 to +22.000 Ω | 0.200 Ω | 0.001 Ω |
| 500 Ω | | • | | -55.00 to +55.00 Ω | 0.50 Ω | 0.01 Ω |
| 100 Ω | | • | | -110.00 to +110.00 Ω | 1.00 Ω | 0.01 Ω |
| 200 Ω | | • | | -220.00 to +220.00 Ω | 2.00 Ω | 0.01 Ω |
| 500 Ω | | • | | -550.0 to +550.0 Ω | 5.0 Ω | 0.1 Ω |
| 1 kΩ | | • | | -1.1000 to +1.1000 kΩ | 0.0100 Ω | 0.0001 Ω |
| 2 kΩ | | • | | -2.2000 to +2.2000 kΩ | 0.0200 Ω | 0.0001 Ω |
| 5 kΩ | | • | | -5.500 to +5.500 kΩ | 0.050 Ω | 0.001 Ω |
| 10 kΩ | | | • | -11.000 to +11.000 kΩ | 0.100 Ω | 0.001 Ω |
| 20 kΩ | | | • | -22.000 to +22.000 kΩ | 0.200 Ω | 0.001 Ω |
| 50 kΩ | | | • | -55.00 to +55.00 kΩ | 0.50 Ω | 0.01 Ω |

<Charge module (GL7-CHA)>

[Voltage input]

| Item select | Description |
|-------------|---|
| DC | 50, 100, 200, 500 mV, 1, 2, 5, 10 V |
| AC | 50, 100, 200, 500 mV, 1, 2, 5, 10 V |
| DC-RMS* | 20, 50, 100, 200, 500 mV rms, 1, 2, 5 V rms |
| AC-RMS* | 20, 50, 100, 200, 500 mV rms, 1, 2, 5 V rms |

* The unit used in this module is V (volt).

<DC/AC>

| Range | DC/AC | DC-RMS/AC-RMS | Max. span | Min. resolution |
|--------|-------|---------------|-----------------------|-----------------|
| 20 mV | | ● | -22.000 to +22.000 mV | 0.001 mV |
| 50 mV | ● | ● | -55.00 to +55.00 mV | 0.01 mV |
| 100 mV | ● | ● | -110.00 to +110.00 mV | 0.01 mV |
| 200 mV | ● | ● | -220.00 to +220.00 mV | 0.01 mV |
| 500 mV | ● | ● | -550.0 to +550.00 mV | 0.1 mV |
| 1 V | ● | ● | -1.1000 to +1.1000 V | 0.0001 V |
| 2 V | ● | ● | -2.2000 to +2.2000 V | 0.0001 V |
| 5 V | ● | ● | -5.500 to +5.500 V | 0.001 V |
| 10 V | ● | | -11.000 to +11.000 V | 0.01 V |

<DC-RMS/AC-RMS>

| Range | Max. span | Min. span |
|------------|---------------------------|--------------|
| 20 mV rms | -22.00 to +22.00 mV rms | 0.20 mV rms |
| 50 mV rms | -55.00 to +55.00 mV rms | 0.50 mV rms |
| 100 mV rms | -110.00 to +110.00 mV rms | 1.00 mV rms |
| 200 mV rms | -220.00 to +220.00 mV rms | 2.00 mV rms |
| 500 mV rms | -550.0 to +550.0 mV rms | 5.0 mV rms |
| 1 V rms | -1.1000 to +1.1000 V rms | 0.0100 V rms |
| 2 V rms | -2.2000 to +2.2000 V rms | 0.0200 V rms |
| 5 V rms | -5.500 to +5.500 V rms | 0.050 V rms |

* The unit used in this module is V (volt).

[IEPE/IEPE-RMS/Charge/Charge-RMS]

| Item select | Description |
|-------------|--|
| Charge | 5, 10, 20, 50, 100, 200, 500, 1000, 2000, 5000, 10000, 20000, 50000 m/s ² |
| IEPE | 1, 2, 5, 10, 20, 50, 100, 200, 500, 1000, 2000, 5000, 10000, 20000, 50000 m/s ² |
| Charge-RMS | 5, 10, 20, 50, 100, 200, 500, 1000, 2000, 5000, 10000, 20000, 50000 m/s ² |
| IEPE-RMS | 1, 2, 5, 10, 20, 50, 100, 200, 500, 1000, 2000, 5000, 10000, 20000, 50000 m/s ² |

<IEPE/IEPE-RMS/Charge/Charge-RMS>

| Range | IEPE/IEPE-RMS | Charge/Charge-RMS | Max. span | Min. resolution |
|------------------------|---------------|-------------------|-------------------------------------|------------------------|
| 1 m/s ² | ● | | -1.100 to +1.100 m/s ² | 0.001 m/s ² |
| 2 m/s ² | ● | | -2.200 to +2.200 m/s ² | 0.001 m/s ² |
| 5 m/s ² | ● | ● | -5.500 to +5.500 m/s ² | 0.001 m/s ² |
| 10 m/s ² | ● | ● | -11.000 to +11.000 m/s ² | 0.001 m/s ² |
| 20 m/s ² | ● | ● | -22.000 to +22.000 m/s ² | 0.001 m/s ² |
| 50 m/s ² | ● | ● | -55.000 to +55.000 m/s ² | 0.01 m/s ² |
| 100 m/s ² | ● | ● | -110.00 to +110.00 m/s ² | 0.01 m/s ² |
| 200 m/s ² | ● | ● | -220.00 to +220.00 m/s ² | 0.01 m/s ² |
| 500 m/s ² | ● | ● | -550.00 to +550.00 m/s ² | 0.1 m/s ² |
| 1000 m/s ² | ● | ● | -1100.0 to +1100.0 m/s ² | 0.1 m/s ² |
| 2000 m/s ² | ● | ● | -2200.0 to +2200.0 m/s ² | 0.1 m/s ² |
| 5000 m/s ² | ● | ● | -5500.0 to +5500.0 m/s ² | 0.1 m/s ² |
| 10000 m/s ² | ● | ● | -11000 to +11000 m/s ² | 1 m/s ² |
| 20000 m/s ² | ● | ● | -22000 to +22000 m/s ² | 1 m/s ² |
| 50000 m/s ² | ● | ● | -55000 to +55000 m/s ² | 1 m/s ² |

<IEPE/IEPE-RMS Input>**Settings of the range and voltage sensitivity**

| Input setting | Voltage sensitivity Range | Voltage sensitivity Unit: mV/(m/s ²) | | | | | | | | | | | | | | |
|-----------------------|------------------------------|--|------------------|------------------|------------------|-----------------|-----------------|------------------|-------------------|------------------|--------------------|---------------------|----------------------|----------------------|----------------------|---|
| | | 0.0100 to 0.0200 | 0.0201 to 0.0500 | 0.0501 to 0.2000 | 0.2001 to 0.5000 | 0.5001 to 1.000 | 1.0001 to 2.000 | 2.0001 to 5.0000 | 5.0001 to 10.0000 | 10.001 to 20.000 | 20.0001 to 50.0000 | 50.0001 to 100.0000 | 100.0001 to 200.0000 | 200.0001 to 500.0000 | 500.0001 to 999.9999 | |
| IEPE/ IEPE- RMS | 1 m/s ² | | | | | | | | | | | | • | • | • | • |
| | 2 m/s ² | | | | | | | | | | | • | • | • | • | • |
| | 5 m/s ² | | | | | | | | | • | • | • | • | • | • | • |
| | 10 m/s ² | | | | | | | | • | • | • | • | • | • | • | • |
| | 20 m/s ² | | | | | | | • | • | • | • | • | • | • | | |
| | 50 m/s ² | | | | | • | • | • | • | • | • | • | • | | | |
| | 100 m/s ² | | | | | • | • | • | • | • | • | • | | | | |
| | 200 m/s ² | | | | • | • | • | • | • | • | • | | | | | |
| | 500 m/s ² | | | • | • | • | • | • | • | • | | | | | | |
| | 1000 m/s ² | | • | • | • | • | • | • | • | | | | | | | |
| | 2000 m/s ² | | • | • | • | • | • | • | | | | | | | | |
| | 5000 m/s ² | • | • | • | • | • | • | | | | | | | | | |
| | 10000 m/s ² | • | • | • | • | • | | | | | | | | | | |
| | 20000 m/s ² | • | • | • | • | | | | | | | | | | | |
| | 50000 m/s ² | • | • | • | | | | | | | | | | | | |

<Charge/Charge-RMS Input>**Settings of the range and charge sensitivity**

| Input setting | Charge sensitivity Range | Charge sensitivity Unit: mV/(m/s ²) | | | | | | | | | |
|--------------------------|-----------------------------|---|------------------|------------------|-------------------|--------------------|--------------------|---------------------|----------------------|----------------------|----------------------|
| | | 0.0100 to 0.5000 | 0.5001 to 2.0000 | 2.0001 to 5.0000 | 5.0001 to 10.0000 | 10.0001 to 20.0000 | 20.0001 to 50.0000 | 50.0001 to 100.0000 | 100.0001 to 200.0000 | 200.0001 to 500.0000 | 500.0001 to 999.9999 |
| Charge Charge- RMS | 1 m/s ² | | | | | | | | | • | • |
| | 2 m/s ² | | | | | | | | | • | • |
| | 5 m/s ² | | | | | | • | • | • | • | |
| | 10 m/s ² | | | | | | • | • | • | • | |
| | 20 m/s ² | | | | | | • | • | • | • | |
| | 50 m/s ² | | | | • | • | • | • | • | • | |
| | 100 m/s ² | | | | • | • | • | • | • | | |
| | 200 m/s ² | | | • | • | • | • | • | | | |
| | 500 m/s ² | | • | • | • | • | • | | | | |
| | 1000 m/s ² | • | • | • | • | • | | | | | |
| | 2000 m/s ² | • | • | • | • | • | | | | | |
| | 5000 m/s ² | • | • | • | • | | | | | | |
| | 10000 m/s ² | • | • | • | | | | | | | |
| | 20000 m/s ² | • | • | | | | | | | | |
| | 50000 m/s ² | • | | | | | | | | | |

(11)-3 Filter

Selects a filter

<Voltage module>

The voltage module filter is the analogue low-pass filter

| Item select | Description |
|-------------|---|
| Off | Filter is not in use. |
| Line | Cutoff frequency is approximately 1.5 Hz. |
| 5Hz | Cutoff frequency is approximately 5 Hz. |
| 50Hz | Cutoff frequency is approximately 50 Hz. |
| 500Hz | Cutoff frequency is approximately 500 Hz. |

<Voltage/Temperature module>

The filter of the Voltage/Temperature module is the moving average below.

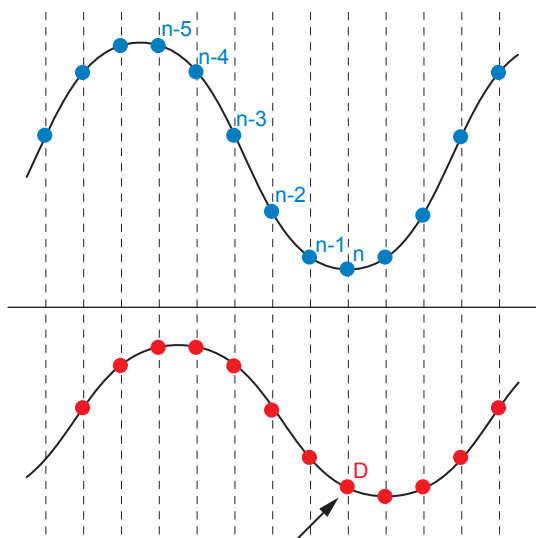

When "5" for filter setting is selected,
 $D = (n-4 + n-3 + n-2 + n-1 + n) \div 5$

| Item select | Description |
|-------------|--|
| Off | No moving average. |
| 2 | Sample interval: moving average 2 times |
| 5 | Sample interval: moving average 5 times |
| 10 | Sample interval: moving average 10 times |
| 20 | Sample interval: moving average 20 times |
| 40 | Sample interval: moving average 40 times |

CHECKPOINT

If the sample interval is shorter than 10ms, the data will be the average value obtained during 10ms. Similarly, if the sample interval is longer than 5 seconds, the data will be the average value obtained during 5 seconds.

<High-speed voltage module/High-voltage module>

The high-speed voltage module and high voltage module filter is the low-pass filter on the analog circuit.

| Item select | Description |
|-------------|---|
| Off | Filter is not in use. |
| Line | Cutoff frequency is approximately 1.5 Hz. |
| 5 Hz | Cutoff frequency is approximately 5 Hz. |
| 50 Hz | Cutoff frequency is approximately 50 Hz. |
| 500 Hz | Cutoff frequency is approximately 500 Hz. |
| 5 kHz | Cut-off frequency is approx. 5 kHz. |
| 50 kHz | Cut-off frequency is approx. 50 kHz. |

<Logic/Pulse module>

The Logic/Pulse module filter is the low-pass filter on the analogue circuit.

| Item select | Description |
|-------------|--|
| Off | Filter is not in use. |
| On | Cutoff frequency is approximately 50 Hz. |

<DC strain module/Charge module>

The filter used in the DC strain module is a low-pass filter only.

| Item select | Description |
|-------------|---|
| Off | Filter is not used. |
| Line | Cut-off frequency is approx. 1.5 Hz. |
| 3 Hz | Cut-off frequency is approx. 3 Hz. |
| 6 Hz | Cut-off frequency is approx. 6 Hz. |
| 10 Hz | Cut-off frequency is approx. 10 Hz. |
| 30 Hz | Cut-off frequency is approx. 30 Hz. |
| 50 Hz | Cut-off frequency is approx. 50 Hz. |
| 60 Hz | Cut-off frequency is approx. 60 Hz. |
| 100 Hz | Cut-off frequency is approx. 100 Hz. |
| 300 Hz | Cut-off frequency is approx. 300 Hz. |
| 500 Hz | Cut-off frequency is approx. 500 Hz. |
| 1 KHz | Cut-off frequency is approx. 1 kHz. |
| 3 KHz | Cut-off frequency is approx. 3 kHz. |
| 5 KHz | Cut-off frequency is approx. 5 kHz. |
| 10 KHz | Cut-off frequency is approx. 10 kHz. |
| Automatic | A.A.F (Anti-aliasing filter) This filter is used to eliminate the aliasing errors that may occur during sampling, which automatically functions depending on the sampling. |

<Charge module>

* High-pass filter is used in the charge module only.

| Item select | Description |
|-------------|--------------------------------------|
| Off | Filter is not used. |
| 0.15Hz | Cut-off frequency is approx. 0.15Hz. |
| 1Hz | Cut-off frequency is approx. 1Hz. |
| 10Hz | Cut-off frequency is approx. 10Hz. |

(11)-4 EU (Scaling settings)

Unit changing the measurement signal.

<When the input is voltage>

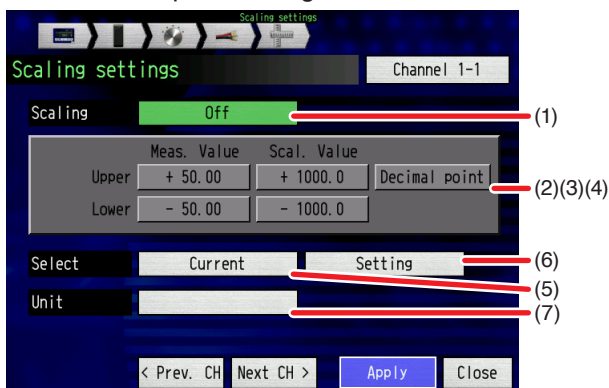

<When the input is temperature>

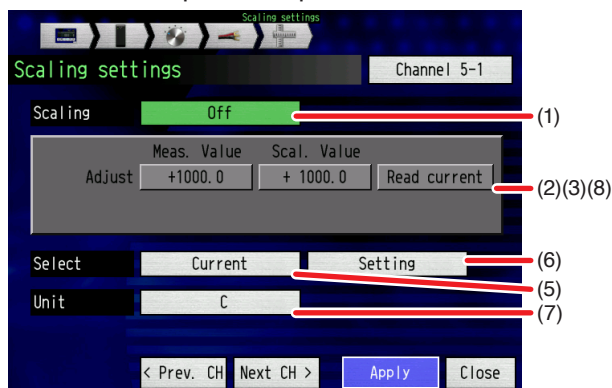

<When the input is pulse>

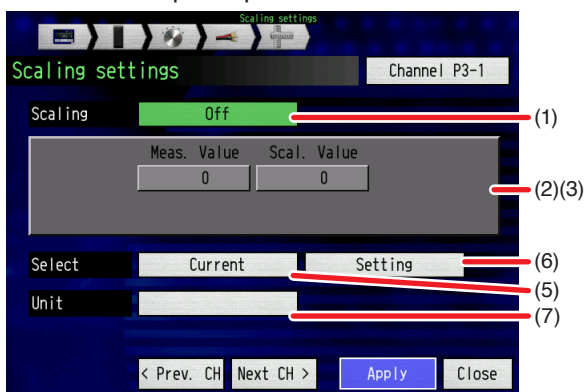

<When setting the Voltage and Charge for the charge Module>

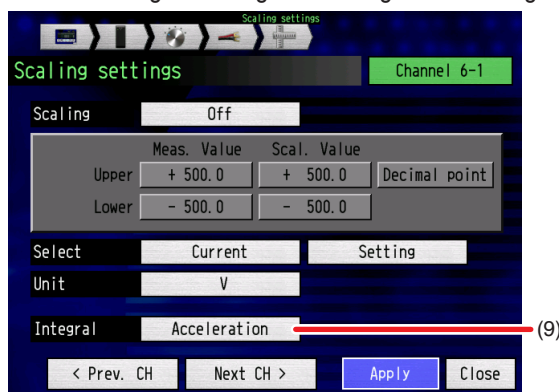

| Item select | | Examples of item |
|-------------|---------------------------------------|--|
| (1) | Scaling | Selects if the scaling function is ON/OFF. |
| (2) | Meas. Value (Upper/Lower limit value) | Sets the upper limit value/lower limit value of the replacement source value. * If the input is temperature, there is no distinction between upper and lower limit values. For details, refer to set examples below. |
| (3) | Scal. Value (Upper/Lower limit value) | Sets the upper/lower limit value after changing. * If the input is temperature, there is no distinction between upper and lower limit value. For details, refer to set examples below. |
| (4) | Decimal | Sets the EU output value decimal position. |
| (5) | Select | Categories |
| (6) | Unit selection | Selects the unit after selected replacement. The unit displayed here is the unit for the categories selected in "Categories". When setting a unit not displayed here, please set it to an optional character in "Units". Further, the contents set here are displayed in "Units". |
| (7) | Unit | Sets the unit after replacing. If the unit uses alphabet or numerical values, it can be set to optional characters. (For details on entering characters, refer to "(2) Enter a character" on page 3-26) When using "Unit selection" its reflected here. |
| (8) | Read current | Substitute the currently measured value in the measurement value (2) and the output value (3). * When the measured value is burned out or scaled over, the value can not be substituted. (When the temperature is used as the input) |
| (9) | Integral | The output acceleration of the acceleration sensor is integrated and converted to the velocity and displacement. |

CHECKPOINT

- If a message window is displayed, please follow the instructions in the window and change the measured values.
- The scaling function is calculated from the ratio of the measured values and output value. If it becomes a replacement value that cannot be processed by the GL7000 +++++/---- is shown on the digital display.
- Depending on the scaling setting contents, the span may change.
- If the input is temperature, its set to the input value offset setting.

Set example: When the input is voltage

| | Measured values | EU output value | Decimal | Unit |
|-------------------|-----------------|-----------------|---------|------|
| Upper limit value | +5.000 | +20.00 | +xx.xx | rpm |
| Lower limit value | -5.000 | -20.00 | | |

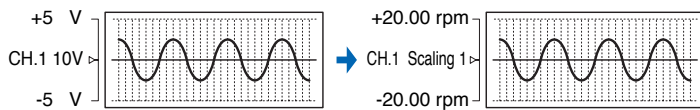

Set example: When the input is temperature

| Measured values | EU output value |
|-----------------|-----------------|
| 22.0°C | 25.0°C |

The set value is already 3°C plus.

Set example: When the input is pulse

| Measured values | EU output value | Decimal | Unit |
|-----------------|-----------------|---------|------|
| 1000 | 800 | +xx.xx | rpm |

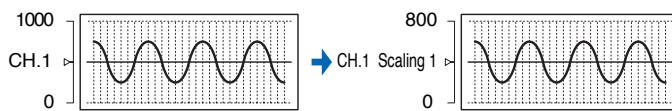

(11)-5 Annotation

Sets the annotation(comment) to be displayed on the CH. The maximum number of characters of each string is 31.

Possible characters for input are kana, alphanumeric characters and symbols.

(For details on entering characters, refer to "(2) Enter a character" on page 3-26)

(11)-6 Span

Sets the upper and lower limit values for the waveform display span.

(11)-7 Inter-CH operation settings

Sets the contents for calculation between channels.

4 calculation rules (+, -, ×, ÷) can be set for calculation between channels.

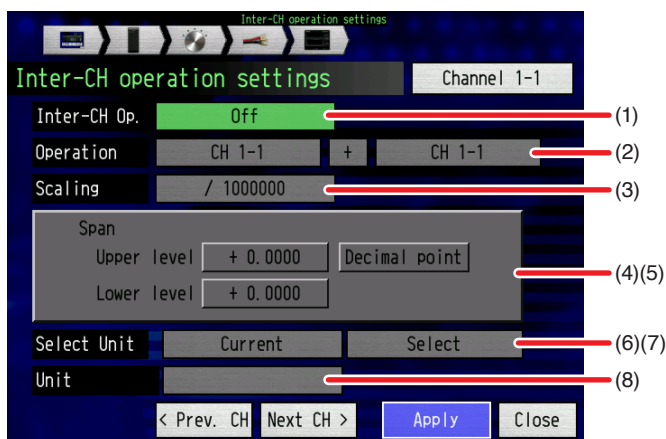

| Item select | | Examples of item |
|-------------|-------------------------|---|
| (1) | Inter-CH Op. | Selects whether to use the Calculation between Channels function. |
| (2) | Operation | Set by the following equation. CH-X and CH-Y is set to analogue CH. CH-X(function) CH-Y |
| (3) | Scaling | /1000000, /1000, ×1, ×1000, ×1000000 Sets the scaling factor for the calculated result <Ex.> Calculated result = 0.001 calculated result = 1000 ×1 : 0.001 ×1 : 1000 ×1000 : 1 /1000 : 1 ×1000000 : 1000 /1000000 : 0.001 |
| (4) | Upper level/Lower level | Sets the upper and lower limit values for the waveform display span. The set value is the value of the calculated result. |
| (5) | Decimal point | Selects the span settings decimal position. |
| (6) | Select Unit | Categories |
| (7) | | Select |
| (8) | Unit | This unit will be displayed on the unit screen. By selecting a unit at (7), that unit is automatically entered. When you want to display a unit not in the unit selection, please enter characters here. |

CHECKPOINT

- The calculated result is displayed by the bolt unit.
- By calculating 100mV+100mV, the calculated result is 0.2V If you want to display 200mV, please use scaling.
- Calculating between Channels can be used when sampling rate is slower than 100ms.
- The result of the calculation is displayed on the channel you set the calculation.

(11)-8 Other settings

Sets other contents.

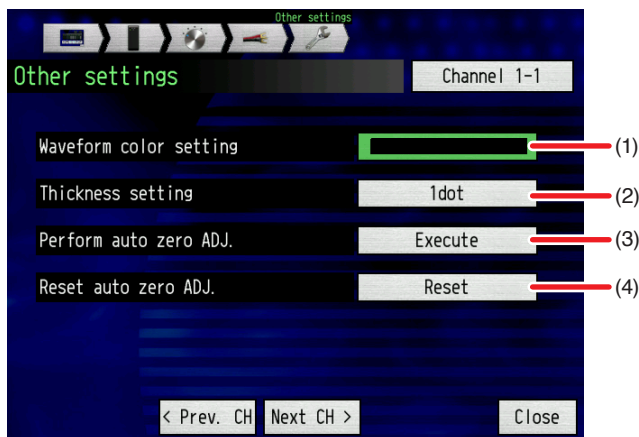

| Item select | | Description |
|-------------|------------------------|---|
| (1) | Waveform color setting | Sets the waveform color. |
| (2) | Thickness setting | Sets the waveform line width. |
| (3) | Perform auto zero ADJ. | Calculates the current voltage input as the zero point voltage value. The possible automatic adjustment is inside $\pm 10\%$ of the set range of the voltage area. <Ex.> In case of 1V range, the possible adjustment area for input voltage is between -0.1V and +0.1V. If the input is temperature, this function cannot be used. |
| (4) | Reset auto zero ADJ. | Zero point adjustment reset. |

The DC strain module and charge module provide the dedicated function for connecting to the sensor.

<DC Strain module>

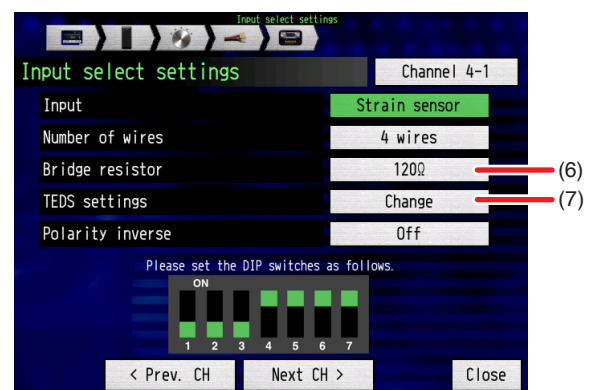
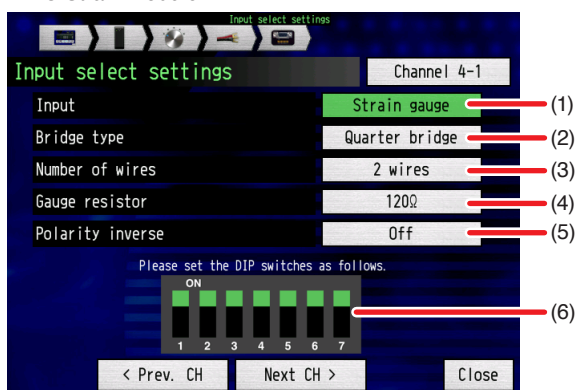

| Item select | | Description |
|-------------|------------------|---|
| (1) | Input | Set according to the strain gauge, strain sensor, voltage and resistance. |
| (2) | Bridge type | Set the type of gauge to be used when the strain gauge is performed. |
| (3) | Number of wires | Set the number of wires for the strain gauge. |
| (4) | Gauge resistor | Set depending on the gauge type. |
| (5) | Polarity inverse | The polarity (+/-) of the input signal can be inverted. |
| (6) | DIP switch | When Input, Bridge type, Number of wires are set, the information of the DIP switch is displayed in the front of module. Set the DIP switch depending on the information. |
| (7) | Bridge resistor | Set the bridge resistor in the strain sensor to be used. |
| (8) | TEDS settings | When using the strain sensor with TEDS function, this is used. Get TEDS information, Save TEDS information or Read TEDS information is performed. |

CHECKPOINT

Make sure to set the DIP switch to measure in accordance with the settings.

<Charge module>

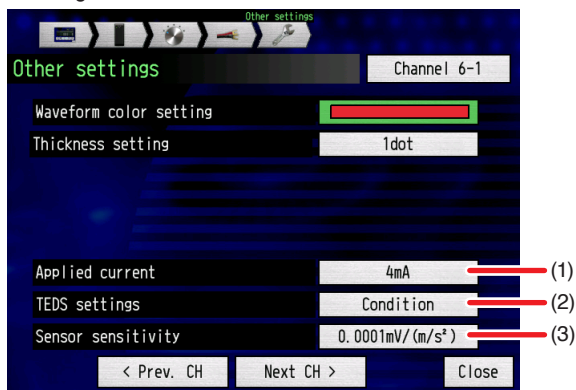

| Item select | | Description |
|-------------|--------------------|--|
| (1) | Applied current | Set the applied current when using the sensor with IEPE. |
| (2) | TEDS settings | This is used when using the acceleration sensor with TEDS function. Get TEDS information, Save TEDS information or Read EDS information is performed. |
| (3) | Sensor sensitivity | Set the sensor sensitivity for IEPE and Charge system. The measurement range varies depending on this setting. (Refer to the table for the acceleration input range on page 3-96.) When the sensor that is displayed as G (PC/G or mV/G) is used, the value divided by 9.8 should be set. <Example> 500mV/G → 51.02mV/ (m/s ²) |

(12) Trigger level settings

Sets detailed settings of each channel when a trigger's start source, stop source is set to "Level Values". The level trigger is determined for each channel by the contents set here. The results are combined and the establishment (or lack thereof) for the whole trigger is decided (refer to the chart below).

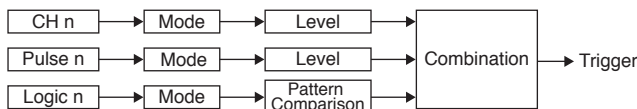

- Pulse and logic are changed with each module
- Combination settings for each module may be set to only one type. When the settings are changed, all modules are set to the same content. When settings are changed, all modules are set to the same content.

<When using Voltage, Voltage/Temperature, High-speed Voltage, High-voltage DC strain/Charge/Voltage Output module>

<In case of pulse with the Logic/Pulse module>

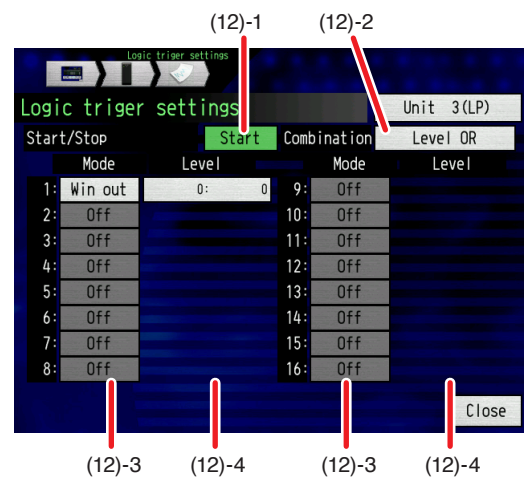
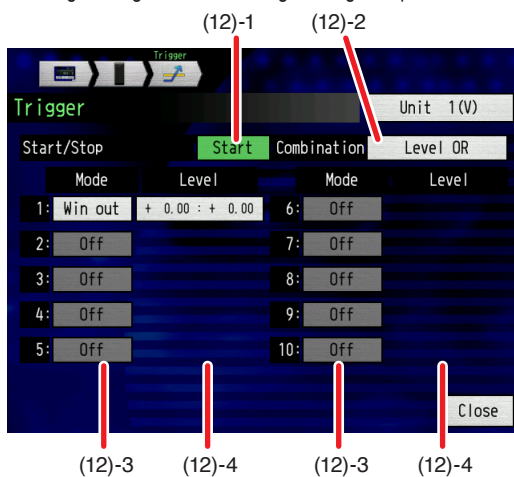

| Item select | | Examples of item | |
|-------------|-------------------|--|--------------------------------------|
| (12)-1 | Start/Stop | Start, Stop | |
| (12)-2 | Combination | Level OR, Level AND, Edge OR, Edge AND | |
| (12)-3 | Mode | Off, H, L, Win in, Win out | |
| (12)-4 | H | Level | |
| | L | Level | |
| | Win in Win out | Upper level/ Lower level | Upper limit value Numerical entry |
| | | | Numerical entry |

<In case of Logic with the Logic/Pulse module>

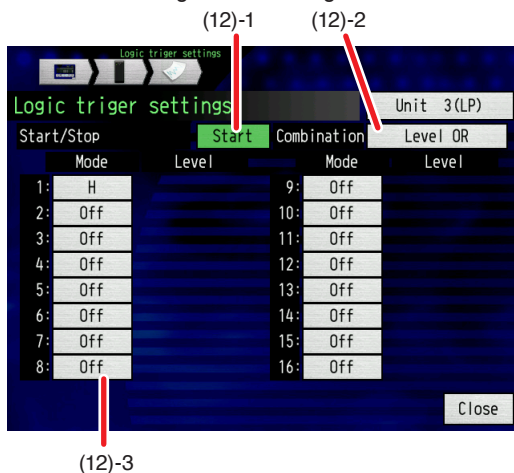

| Item select | | Examples of item | |
|-------------|-------------|---|--|
| (12)-1 | Start/Stop | Start, Stop | |
| (12)-2 | Combination | Level OR, Level AND, Edge OR, Edge AND | |
| (12)-3 | Mode | When channel is set to Logic : Off, H, L, Win in, Win out When channel is set to Pulse: Off, H, L, Win in, Win out | |

(12)-1 Start/Stop

Selects settings related to the start side source or the stop side source.

(12)-2 Combination

Sets the combination of set trigger conditions for each channel.

| Item select | Description |
|-------------|--|
| Level OR | If at least 1 of the set trigger conditions is satisfied, recording starts (stops). Each condition becomes a level action. |
| Level AND | If all of the set trigger conditions are satisfied, recording starts (stops). Each condition becomes a level action. |
| Edge OR | If at least 1 of the set trigger conditions is satisfied, recording starts (stops). Each condition becomes an edge action. |
| Edge AND | If all of the set trigger conditions are satisfied, recording starts (stops). Each condition becomes an edge action. |

Level action and edge action

For level action, if the condition is satisfied when the "START" key is pressed, the trigger condition is considered satisfied.

For edge action, even if the condition is satisfied when the "START" key is pressed, it's not considered to be fulfilled. The condition can only be fulfilled by once the condition is once unfulfilled, and then once again satisfied.

* Once the Edge action is established, even should the condition cease to be fulfilled, it will still be considered satisfied.

<Ex.> Level action

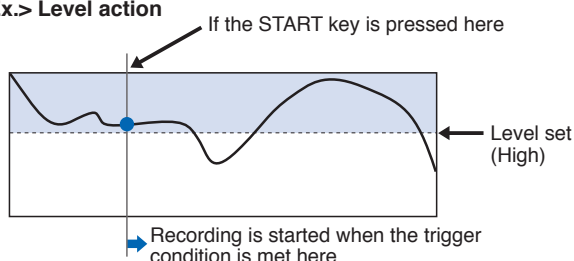

<Ex.> Edge action

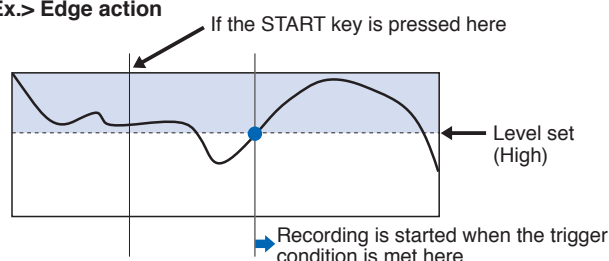

<Ex.> Level AND action

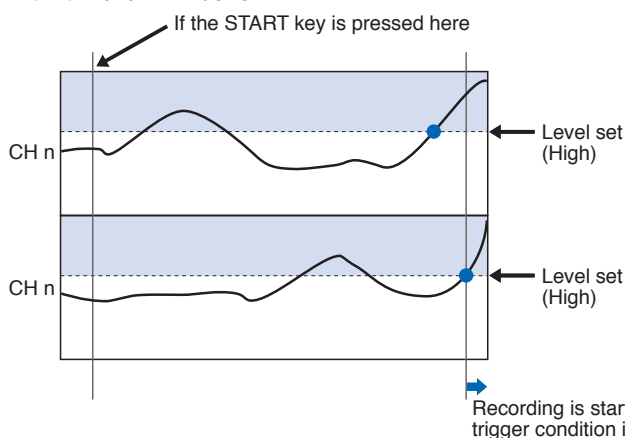

<Ex.> Edge AND action

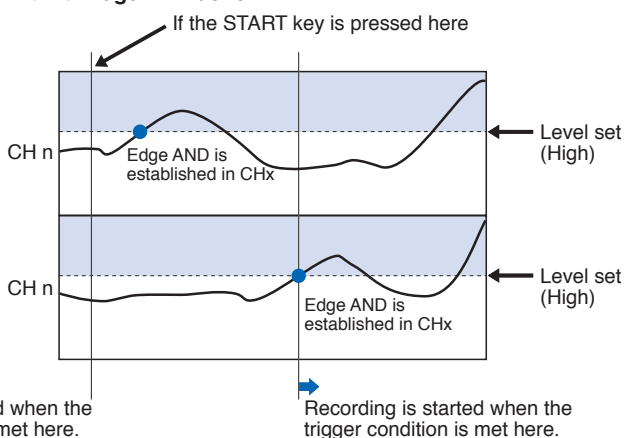

(12)-3 Mode

Sets the trigger comparison mode for each channel.

High: Condition where a trigger/alarm occurs when the input signal exceeds a set level.

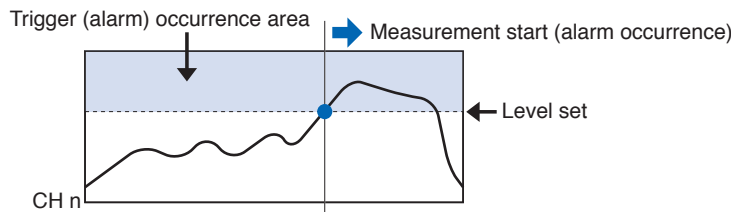

Low: Condition where a trigger/alarm occurs when the input signal exceeds a set level.

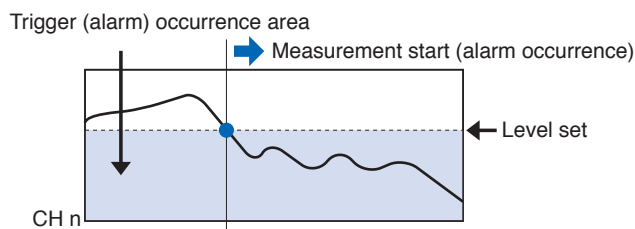

Win in: Condition where a trigger/alarm occurs when for any channel, the upper and lower limit value is set, and an input signal between those levels is input (when a signal is input).

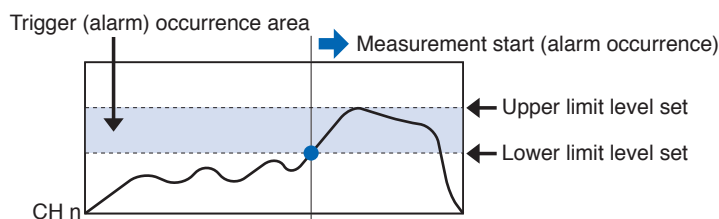

Win out: Condition where a trigger/alarm occurs when for any channel, the upper and lower limit value is set, and an output signal between those levels is output (when a signal is output)

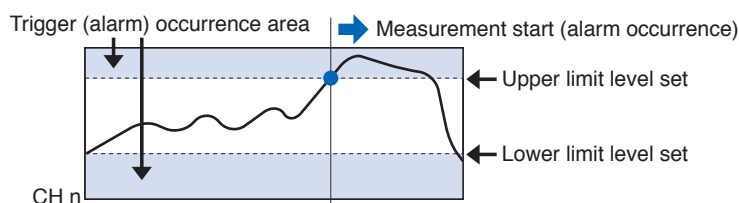

* These figures explain Trigger modes, but also work with alarm mode.

Detection of the trigger

To improve the detection rate of the trigger in the GL7000, the detection of the trigger is performed in the following interval, regardless of the sampling interval.

Therefore, when the sample interval is slower than the following detection interval of the trigger, or the measured signal is changed faster than the sample interval, the data at the trigger establishment may not be recorded, even if the trigger is successfully established.

<Trigger detecting interval>

- High Speed Voltage module (GL7-HSV) : 1 μ s
- Voltage module (GL7-V) : 1 ms
- Voltage/Temperature module (GL7-M) : Sampling interval is 10 ms or less (10 ms).
Sampling interval is 20 ms to 2 s (sampling interval).
Sampling interval is 5 s or more (5 s).
- Logic/Pulse module (GL7-L/P) : 1 s when Logic is used.
100 μ s when Pulse is used.
- High Voltage module (GL7-HV) : 1 μ s

(12)-4 Level/Upper limit value/Lower limit value

Sets the trigger comparison level.

If the mode is "High" or "Low", it's set to a 1 field comparison level. If the mode is "Win in" or "Win out", its set to a 2 field comparison level.

Hysteresis

A hysteresis is set up in the trigger levels in order to prevent false positives due to noise. The hysteresis is as shown on the chart below.

Therefore, even for level sets, errors as shown in the chart below may occur.

<Ex.>

Combination : Edge OR

Mode : High

Level : 0.5 V

• **When the hysteresis is not provided**

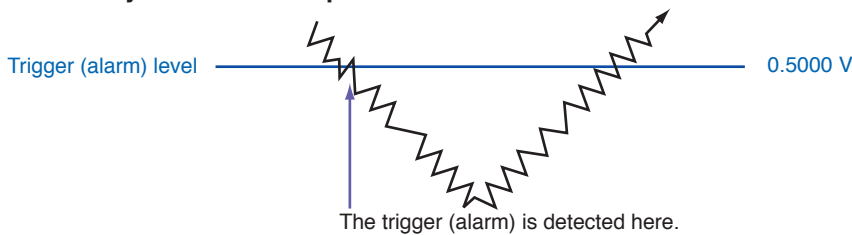

* If the hysteresis is not provided, the rising may be detected even when the rising has been set.

• **When the hysteresis is provided (GL7000)**

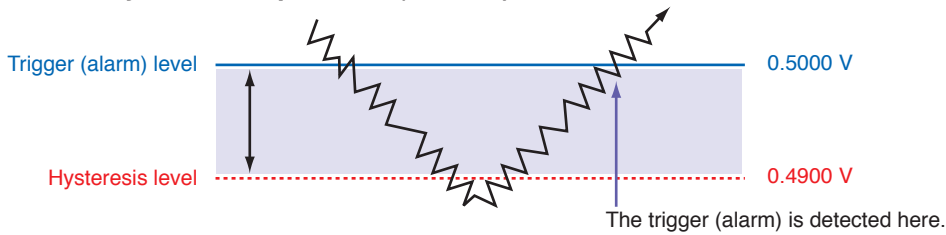

* For Rising mode, when the signal level drops below the hysteresis level at a time, and then becomes greater than or equal to trigger (alarm) level, the trigger (alarm) is detected.

Hysteresis level

Each Hysteresis level is as shown below.

• **<Mode: Rising>**

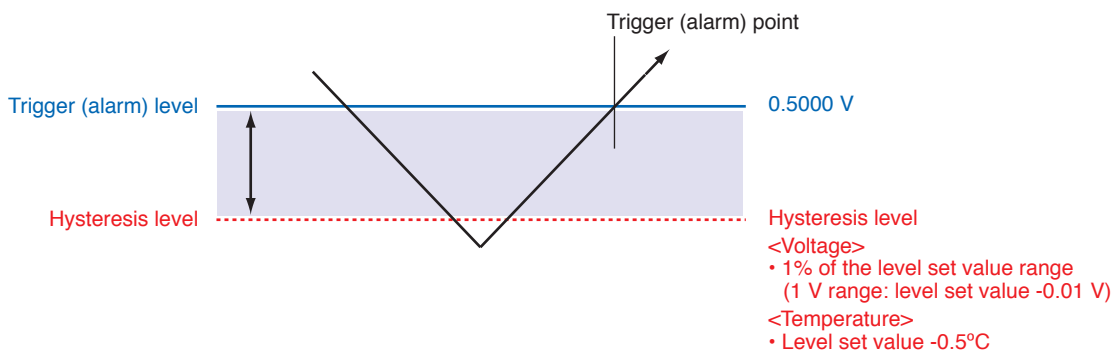

CHECKPOINT

- The upper limit values within the mode range and the lower limit values out of the mode range are hysteresis level as well.
- An error of the trigger (alarm) level is the same as the voltage accuracy and temperature accuracy.
- When the detected alarm drops below the hysteresis level, it is cleared. (When the alarm is retained).
- For Pulse mode, the Hysteresis level is not provided.

- <Mode: Low>

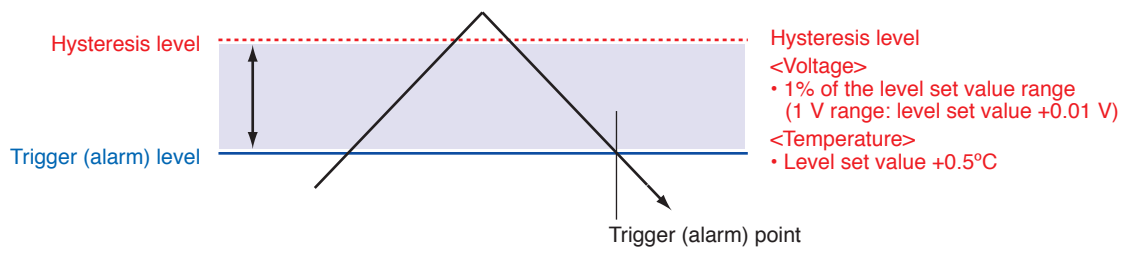

CHECKPOINT

- The upper limit values within the mode range and the lower limit values out of the mode range are hysteresis level as well.
 - An error of the trigger (alarm) level is the same as the voltage accuracy and temperature accuracy.
 - When the detected alarm drops below the hysteresis level, it is cleared. (When the alarm is retained).
 - For Pulse mode, the Hysteresis level is not provided.
-

(13) Alarm level settings

("Home" → "Each Amplifier Module" → "Alarm level settings")

Sets alarm occurrence conditions, output destination etc. If the conditions set here are satisfied, an alarm is output from the Alarm Module terminal (specifies the output destination number for each CH).

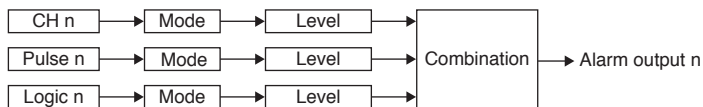

- Pulse and Logic changes per module.
 - Combination settings for each module may be set to only one type. All modules are set to the same settings. When the settings are changed, all modules are set to the same content.
 - Specifies alarm output for each CH, Pulse and Logic. If the combined settings of the alarm output are established, the alarm is outputted.
- <Ex.> If the output destination is set to 1 for CH1 and CH2, and 2 for CH3 and CH4, and Level OR for combination, when the conditions for either CH1 or CH2 are satisfied, alarm output 1 occurs, and when the conditions for either CH3 or CH4 are satisfied, alarm output 2 occurs.

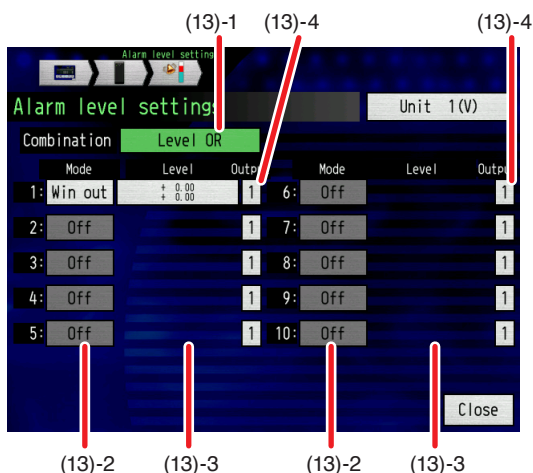

| Item select | | Examples of item | |
|-------------|-------------|--|---|
| (13)-1 | Combination | Level OR, Level AND, Edge OR, Edge AND | |
| (13)-2 | Mode | Off, H, L, Win in, Win out | |
| (13)-3 | H | Level | Numerical entry |
| | L | Win in | Upper level/ Upper limit value Numerical entry |
| | Win out | Lower level | Numerical entry |
| (13)-4 | Output | 1 to 10 (Numerical entry) | |

(13)-1 Combination

Sets combinations of alarm conditions for each channel.

| Item select | Description |
|-------------|---|
| Level OR | If at least 1 of the set alarm conditions is satisfied, the alarm of specified number is output. Each condition becomes a level action. |
| Level AND | If all of the set alarm conditions are satisfied, the alarm of specified number is output. Each condition becomes a level action. |
| Edge OR | If at least 1 of the set alarm conditions is satisfied, the alarm of specified number is output. Each condition becomes an edge action. |
| Edge AND | If all of the set alarm conditions are satisfied, the alarm of specified number is output. Each condition becomes an edge action. |

CHECKPOINT

- The level action/edge action is same as the trigger level. For details, see "Level action and edge action" on page 3-106.
- When the combination of the alarms is set to "Edge OR" or "Edge AND", the alarms are retained regardless of this setting.
- When the alarms are not retained, set the combination of the alarms to "Level OR" or "Level AND".

(13)-2 Mode

Determines the alarm mode for each channel. For details, refer to "(12)-3 Mode" on page 3-107.

(13)-3 Level/Upper limit value/Lower limit value

Sets the levels that determine the alarm.

If the mode is "High" or "Low", its set to a 1 place comparison level. If the mode is "Win in" or "Win out", its set to a 2 place comparison level.

For details, refer to "(12)-4 Level/Upper limit value/Lower limit value" on page 3-108.

(13)-4 Output

Specifies the output destination when an alarm occurs. If multiple CH are set to the same number, it's determined according to preset combinations.

<Ex.>: If the CH1 and CH2 of the amplifier are both set to the number 1 terminal, and the combination is level AND, if an alarm is established on both CH1 and CH2, output will occur on the number 1 alarm output terminal.

(14) Waveform setting (Simple Waveform Setting)

("Home" → "Waveform settings")

Carries out settings related to waveform and digital display.

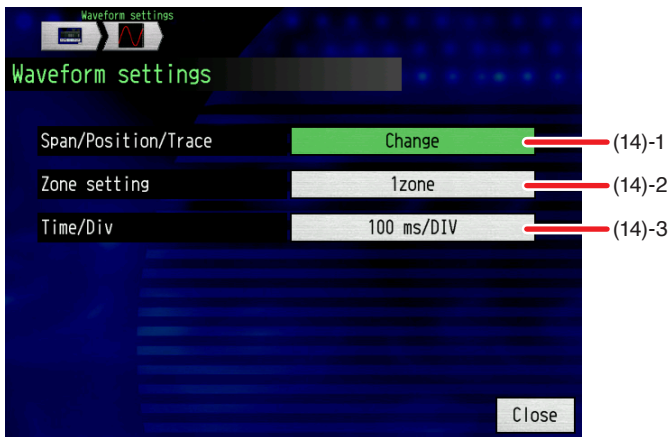

| Item select | | Examples of item | |
|-------------|----------------------|---|-----------|
| (14)-1 | Span/Position /Trace | ↑ Up | ▷ Execute |
| | | ↓ Down | ▷ Execute |
| | | ↕ Expand | ▷ Execute |
| | | ✳ Reduce | ▷ Execute |
| | | Trace | ▷ Execute |
| (14)-2 | Zone setting | 1 zone, 2 zone, 5 zone, 10 zone | |
| (14)-3 | Time/Div | 1/2/5/10/20/50/100/200/500us/DIV, 1/2/5/10/20/50/100/200/500ms/DIV, 1/2/5/10/20/30sec/DIV, 1/2/5/10/20/30min/DIV, 1/2/5/10/12/24hour/DIV | |

(14)-1 Span/Position/Trace

Turns the waveform display On/Off and lets users change settings related to vertical display.

Touching the button for Span/Position/Trace will display the Waveform screen below. You can change the settings while viewing the waveform.

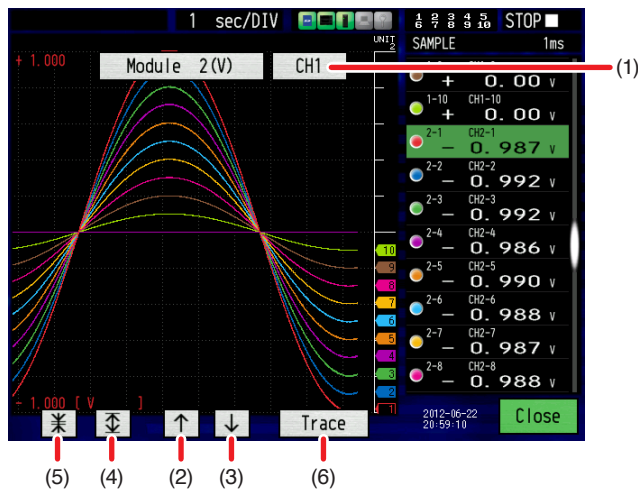

| Item select | Description |
|-----------------------|--|
| (1) Channel Selection | Selects the channel for the waveform processing. |
| (2) ↑ Up | Moves the waveform up. |
| (3) ↓ Down | Moves the waveform down. |
| (4) ⇕ Expand | Expand the waveform. |
| (5) ≡ Reduce | Reduce the waveform. |
| (6) Trace | Changes the waveform display to On/Off. |

(14)-2 Zone setting

Sets the zone for waveform display.

CHECKPOINT

If a zone is set, the channel displayed in each zone is fixed and can not be changed.

(14)-3 Time/DIV

Sets the timescale, the horizontal axis of the waveform display.

CHECKPOINT

When displaying the waveform during free running or during recording, it's displayed from 100ms/DIV. During data replay it's displayed from recorded sampling rate/DIV.

(15) Display settings

Sets display related settings.

("Home" → "Display settings")

<Y-T display settings>

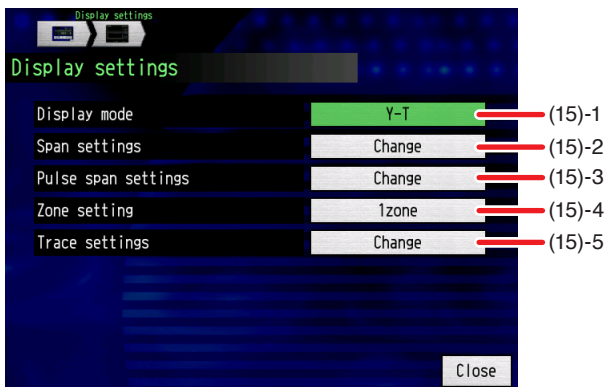

<Y-T (fullscreen) display settings>

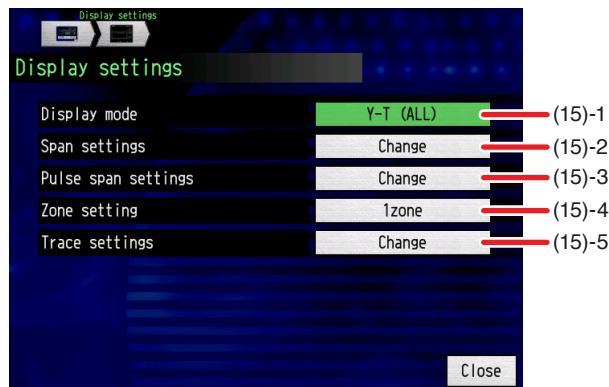

<Logger display settings>



<XY display settings>



<FFT display settings>



| Item select | | Examples of item | |
|-------------|---------------------|------------------|---|
| (15)-1 | Display mode | | Y-T, Y-T (Fullscreen), Logger, XY, FFT |
| (15)-2 | Span settings | Upper | Numerical entry |
| | | Lower | Numerical entry |
| (15)-3 | Pulse span settings | Upper | Numerical entry |
| | | Lower | Numerical entry |
| (15)-4 | Zone setting | | 1 zone, 2 zone, 5 zone, 10 zone |
| (15)-5 | Trace settings | | ▷ Execute |
| (15)-6 | Caic. settings 1 | | Off, Average, Max, Min, Prak |
| (15)-7 | Caic. settings 2 | | Off, Average, Max, Min, Prak |
| (15)-8 | Format | | 2 Division, 4 Division, 10 Division, Statistics |

| Item select | | | Examples of item | | |
|------------------|--|---------------------------|--|---|--|
| (15)-9 | XY display settings | Trace | Execute | | |
| | | X-Axis | CH1 to CH112 | | |
| | | Y-Axis | CH1 to CH112 | | |
| | | Color | Red, Green, Blue (RGB) Each color 0 to 31 | | |
| (15)-10 | FFTdisplay settings | Frequency | 0.08, 0.2, 0.4, 0.8, 1.6, 2, 3.2, 4, 8, 20, 40, 80, 200, 400, 800 Hz, 2, 4, 8, 20, 40, 80, 200, 400 kHz" | | |
| | | Number of analysis points | 500, 1000, 2000, 4000, 10000 | | |
| | | Time window | Rectangular, Hanning, Hamming, Blackman, Flattop, Exponential | | |
| | | Average mode | Off, Summation, Exponential, Peak hold | | |
| | | Average count | Automatic | | |
| | | | Optional | Enter the number. (Lower limit value: 2, Upper limit value: 9999) | |
| | | Display settings | Display format | 1-divided, 2-divided, Nyquist | |
| | | | Grid | Off, On | |
| | | | Zone | Zone1, Zone2 (Displayed with the settings of Zone1 and Zone2) | |
| | | | Function | Y-T, Linear, Power, PSD, Cross, TRF, Coherence, COP | |
| | | | X Axis | Linear, Log | |
| | | | X Axis function | Frequency, Cycle | |
| | | | Y Axis | Linear, Log, Phase | |
| | | | Y Axis auto scale | Off, On | |
| | | | Trace | | Settings of 1 to 4 types |
| | | | | Trace | Off, On |
| | | CH A | | Selection of the calculation channel | |
| | | CH B | | Selection of the calculation channel | |
| | | Calculation settings | Waveform color | Selection of the combination of Red, Green and Blue | |
| | | | Zone | Zone1, Zone2 (Displayed with the settings of Zone1 and Zone2) | |
| | | | CH | Settings of 1 to 4 types | |
| | | | Calculation | CH A Calculation | None, Differential, D-Differential, Integral, D-Integral |
| CH B Calculation | None, Differential, D-Differential, Integral, D-Integral | | | | |
| RMS | Off, On | | | | |
| Smoothing | Off (The setting range of the smoothing varies depending on the analysis frequency.) | | | | |

(15)-1 Display mode

Changes the display mode.

<Y-T display>

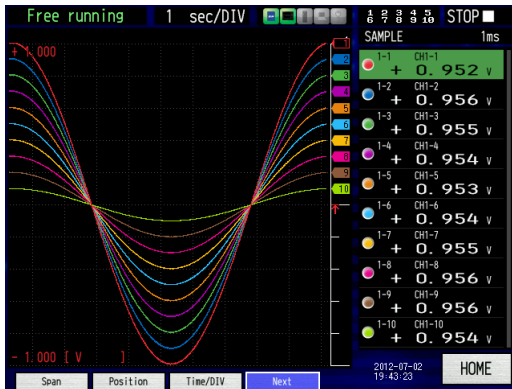

<Y-T (fullscreen) display>

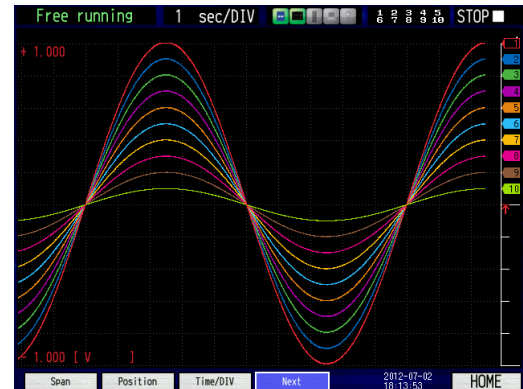

<Logger display>



<X-Y display>



<FFT Display>

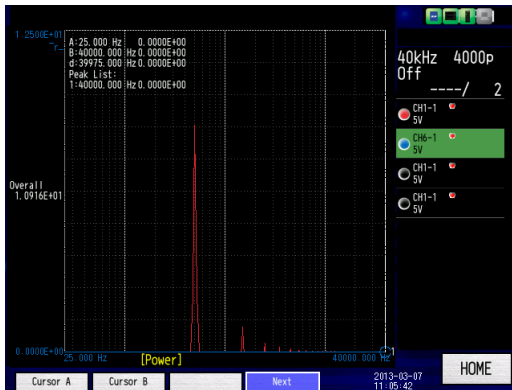

(15)-2 Span settings

Sets the upper and lower limit value for the waveform display span.

CHECKPOINT

This setting is shared with the amplifier span setting.

(15)-3 Pulse span settings

This is available only when the pulse is set in the Logic/Pulse module.
Sets the upper and lower limit value for the pulse waveform display span.

CHECKPOINT

- This setting is displayed when a Logic/Pulse module is connected and a pulse is set.
- This setting is shared with the amplifier span setting.

(15)-4 Zone setting

Sets the zone of waveform display.

CHECKPOINT

If a zone is set, the channel displayed in each zone is fixed and can not be changed.

(15)-5 Trace settings

Changes the display waveform to On/Off for each channel.

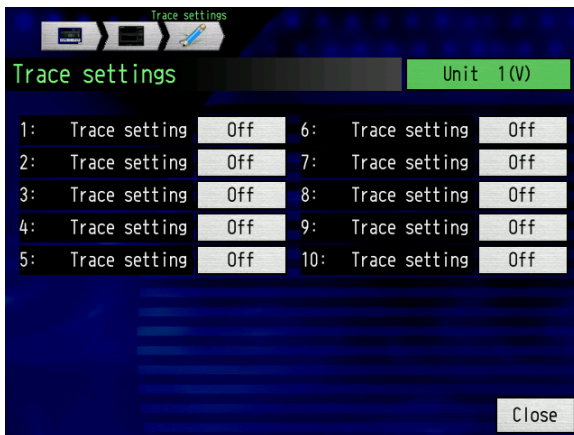

CHECKPOINT

Trace settings do not affect recorded data.

(15)-6, 7 Caic. settings

2 statistics calculations can be executed on the GL7000.
Here the statistics calculation contents is set.

<Sample of the statistical calculation>



| Item select | Description |
|-------------|--|
| Off | Calculation process was not carried out. |
| Average | During recording, the data simple addition average is displayed on the screen. |
| Max | During recording, the maximum value of the data is displayed on the screen. |
| Min | During recording, the minimum value the data is displayed on the screen. |
| Prak | During recording, the peak value of the data is displayed on the screen. |

CHECKPOINT

- The result of the calculation is displayed on the Digital + Statistical Calculation screen in the logger display mode.
- Calculation is started from when the power is turned on, and is cleared by pressing the QUIT key or by pressing the Start key to start measurements.
- Realtime statistics calculation is usable when the sampling rate is slower than 100ms. When the sampling rate is faster than 100ms, use the statistics calculation of the cursor functions after replaying recorded data.

(15)-8 Format

If the display format is a logger, it sets the format of the logger display.

< 2 Division >



< 4 Division >

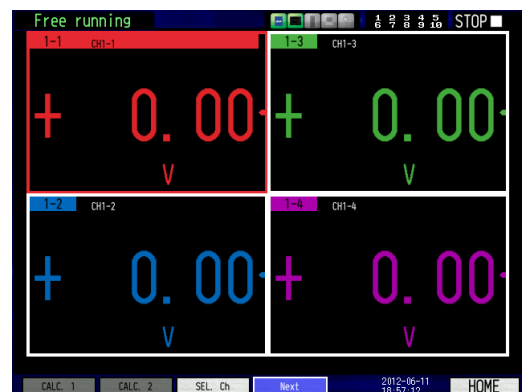

< 10 Division >

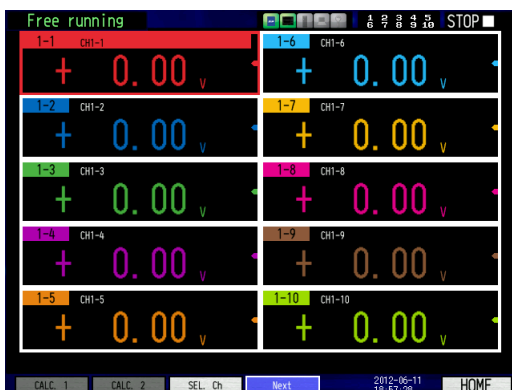

< Statistics >

| CH | VALUE | Max | Min |
|------|-----------|---------|---------|
| 2-1 | - 0.732 V | + 1.011 | - 0.992 |
| 2-2 | - 0.739 V | + 1.005 | - 0.998 |
| 2-3 | - 0.739 V | + 1.007 | - 0.997 |
| 2-4 | - 0.736 V | + 1.012 | - 0.993 |
| 2-5 | - 0.736 V | + 1.010 | - 0.994 |
| 2-6 | - 0.736 V | + 1.010 | - 0.995 |
| 2-7 | - 0.734 V | + 1.011 | - 0.991 |
| 2-8 | - 0.736 V | + 1.009 | - 0.993 |
| 2-9 | - 0.738 V | + 1.009 | - 0.995 |
| 2-10 | - 0.691 V | + 1.011 | - 0.993 |

How to set the channel to be displayed

This section explains how to set the channel to display in each zone.

- (1) By touching the direction keys or directly touching on the screen, select the zone to change the channel. In this case, you can change the Ch1-3.



(2) Touch "Ch selec" function button.

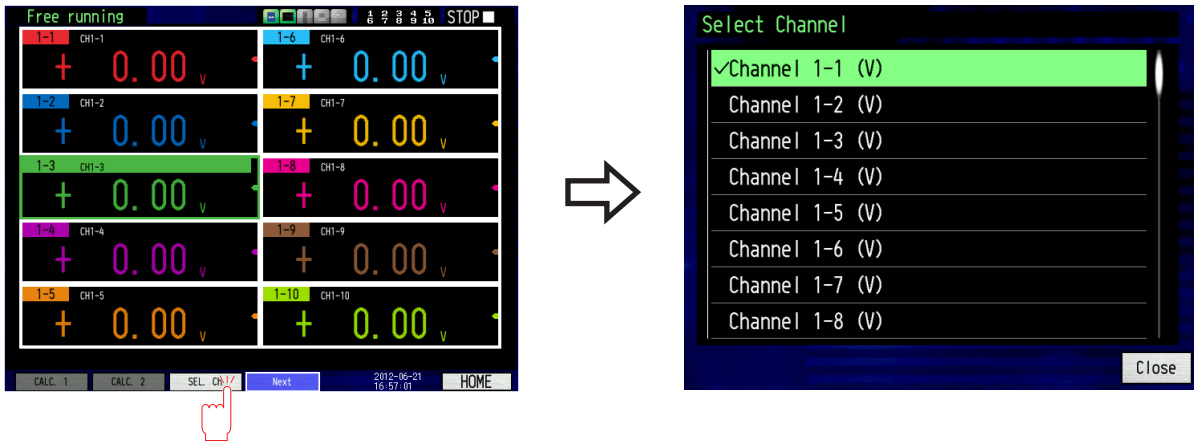

(3) Select the channel you want to view (touch twice).

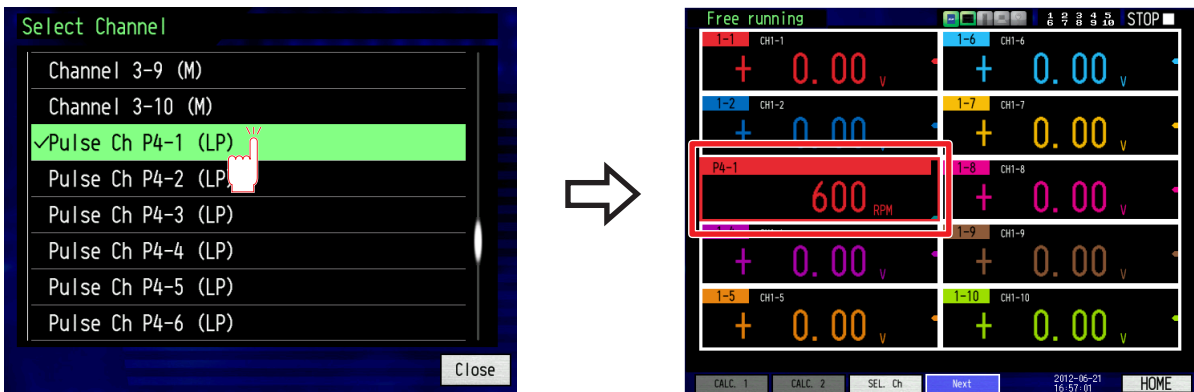

(15)-9 XY display settings

Performs XY display settings.

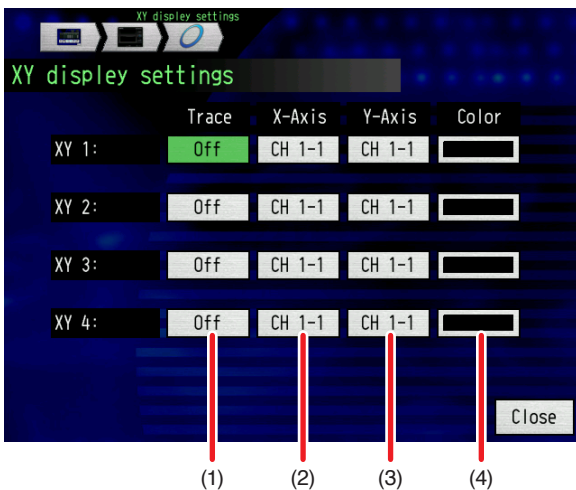

| Item select | | Description |
|-------------|--------|--|
| (1) | Trace | Selects whether to display the waveform or not. |
| (2) | X-Axis | Set the channel to assign to X-axis of each XY waveform. |
| (3) | Y-Axis | Set the channel to assign to Y-axis of each XY waveform. |
| (4) | Color | Sets the waveform color. |

How to operate the XY display

This section explains how to operate the XY display screen.

(1) Drawing waveform

When "Pen-down" function key is touched, the drawing of the waveform XY is performed.

When "Pen-up" function key is touched, the screen changes to the trajectory display without subsequent drawing.

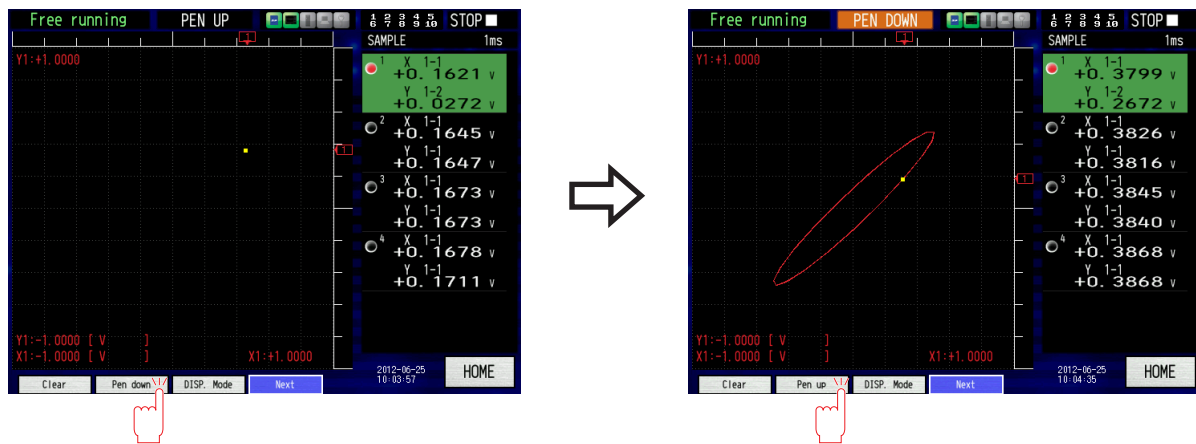

(2) By touching "Clear", the drawing of the XY waveform is deleted.

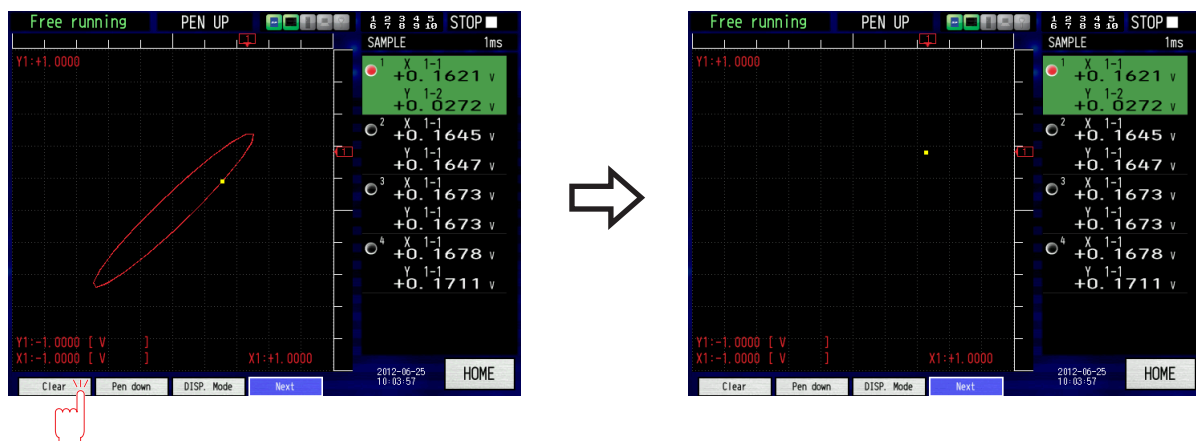

(3) When the recording starts, waveform clear and pen-down are started up automatically, and then the XY waveform is drawn.

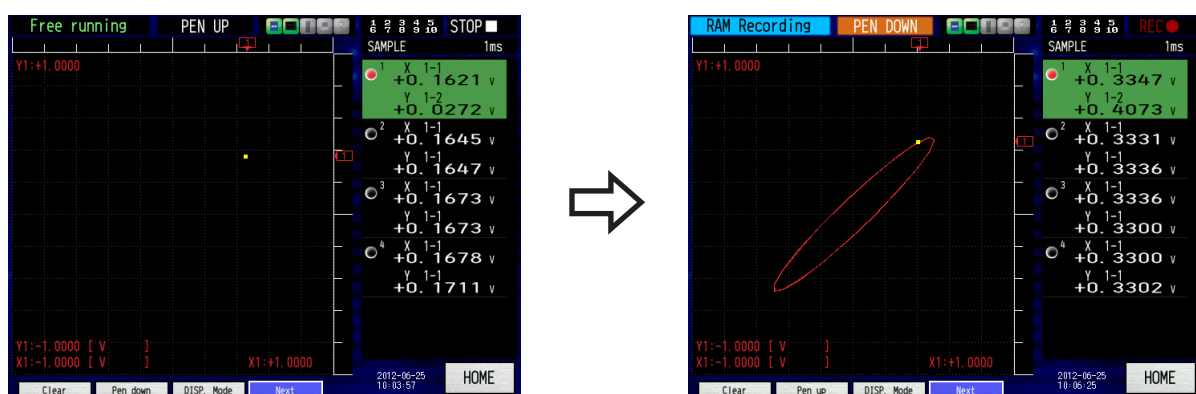

CHECKPOINT

- When the recording starts, pen-down are started up automatically, after finishing the recording, moves to pen-up state.
- Even if the XY waveform drawing is cleared during recording, the data is not affected during recording.
- When the Span Position Trace, etc. are changed during XY replaying, conduct a redraw.

(15)-10 FFT Display settings

This section provides the descriptions of the FFT display settings.

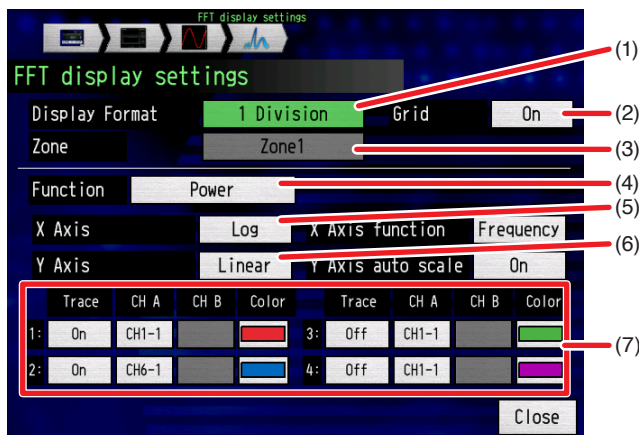

| Item select | Description |
|--------------------|--|
| (1) Display format | Select 1-divided, 2-divided, or Nyquist for FFT screen |
| (2) Grid | Switch the grid display to On or Off. |
| (3) Zone | Set the analysis method of the Zone1 or Zone2 when the 2-divided is selected in the Display format. |
| (4) Function | Select Y-T, Linear, Power, PSD, Cross, TRF, Coherence or COP for FFT analysis. |
| (5) X Axis | Select either Linear or Log for X Axis analysis display. Select either Frequency or Cycle for X Axis analysis function. |
| (6) Y Axis | Select either Linear or Log for Y Axis analysis display. Display the scale properly by switching Y Axis auto scale to On. |
| (7) Trace | Select the analysis channel. Select CH1 or CH2 for Cross, TRF, Coherence and COP in the Function settings. |

1. Display format

- Up to 4 calculation settings can be set in both the 1-divided and 2-divided. FFT analysis of one channel data is displayed.
- The Nyquist allows you to confirm that the correct TRF has been obtained.

The FFT analysis is displayed in one figure by assigning the real part to the vertical axis and the imaginary part to the horizontal axis. Therefore, it is calculated as X Axis is disabled and Y Axis is Linear or Log.

* Nyquist display conditions are not available for Y-T and coherence funtions.

<1-divided>

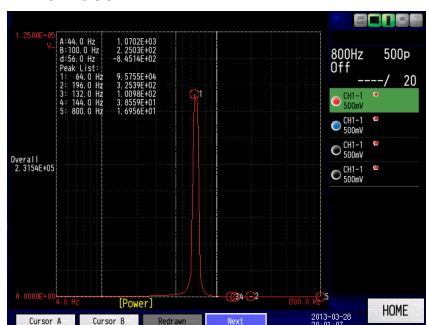

<2-divided>

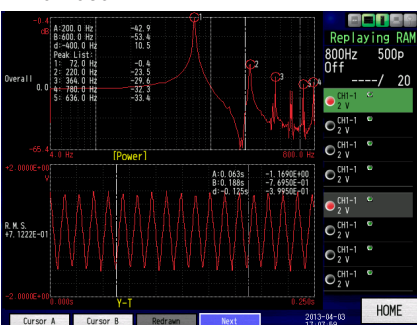

<Nyquist>

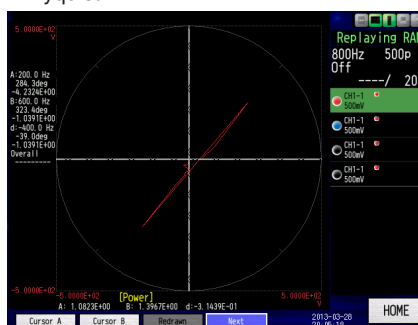

2. Function

Y-T : When X Axis is fixed to the Time, Y Axis is fixed to the Linear, the change of the input signal with respect to the time axis is displayed.

Linear (Linear Spectrum)

: Based on the results of the time axis data processed with FFT calculation, the amplitude or phase of each frequency is displayed.

Power (Power Spectrum)

: Based on the results of the time axis data processed with FFT calculation, the power of each frequency component is displayed.

PSD (Power Spectrum Density)

: The power spectrum per unit interval of frequency is known as PSD. Since the results of the FFT analysis is the value of integral for the spectrum distributed on the bandwidth (Range of the frequency resolution) determined from the analysis frequency and number of analysis points, the power spectrum of the signal such as a continuous spectrum is a value that varies depending on the settings of the analysis frequency range and the number of analysis points. When there is the signal that the spectrum is distributed in such a broad band and the signal is measured with the power spectral density, the cross spectrum measured regardless of the analysis frequency range and the number of analysis points is multiplied by the spectrum of two signals for each frequency component, and the magnitude of the power and the correlation of two signals are displayed.

Cross (Cross Spectrum)

: The cross spectrum measured is multiplied by the spectrum of two signals for each frequency component, and the magnitude of the power and the correlation of two signals are displayed.

The cross spectrum allows you to reduce greatly the effects of noise, as compared with the case where only the power spectrum of the output signal is measured, by averaging the measured cross spectrum of the input and output signals even if there are a system that the noise is mixed in the input signal.

TRF (Transfer function)

: The TRF showing the relationship between the input and output signals can be determined by calculating the ratio of the cross spectrum of the input and output signals and the power spectrum of the input signal.

Similar to the cross spectrum, the averaging process allows you to reduce the effects of noise mixed in the system. However, the input signal contains frequency component across the analysis frequency is required to measure the TRF across the analysis frequency.

Coherence (Coherence Function)

: The coherence is determined by calculating the ratio of the squared amplitude of the cross spectrum of the input and output signal and the product of the power spectrum of the input and output signals, and then the causal relationship between the input and output signals are displayed. The value of the coherence function is between 0 and 1. When the coherence function is 1, all the output signal is caused by the input signal, and when it is 0, the output signal is independent of the input signal at all. The measurement of the coherence function allows you to confirm the reliability of the measurement, such as the TRF. Note that, when the averaging process is not performed, all the value of the coherence function is 1. When using the coherence function, make sure to perform the averaging process.

COP (Coherent Output Power)

: The product of the coherence function and the power spectrum of the output side is displayed.

This is the contents of the FFT Calculation settings screen.

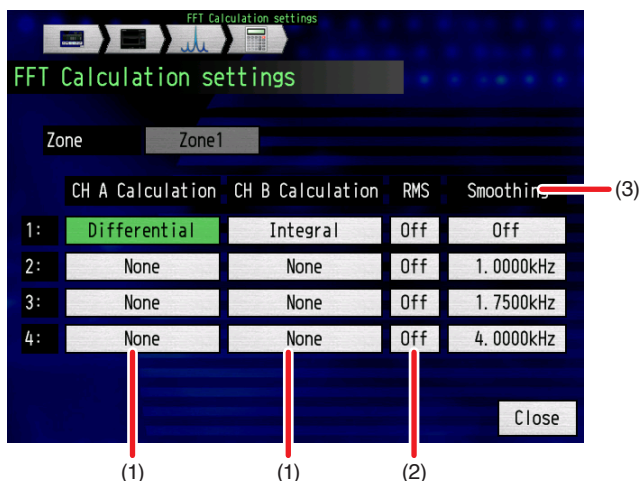

| Item select | Description |
|--|--|
| (1) CH A Calculation CH B Calculation | Set this setting for only the channel you have set the Linear, Power, PSD, Cross, TRF, and Coherence. None, Differential, D-Differential, Integral, or D-Integral can be set as the possible calculation. |
| (2) RMS | "Set this setting only when Linear, Power, PSD, or Cross is set. When this setting is On, Y Axis is displayed with RMS scale. |
| (3) Smoothing | "When the moving average is performed with any frequency width with respect to the results of FFT calculation, the waveform is smoothed. You can select from the items that are calculated from the analysis frequency and the number of analysis points. |

* Zone is enabled when the Display format is set to the 2-divided in FFT display settings.

* It is possible to set to 1 to 4 for the calculation.

This is the contents of the FFT Calculation Result Display screen.

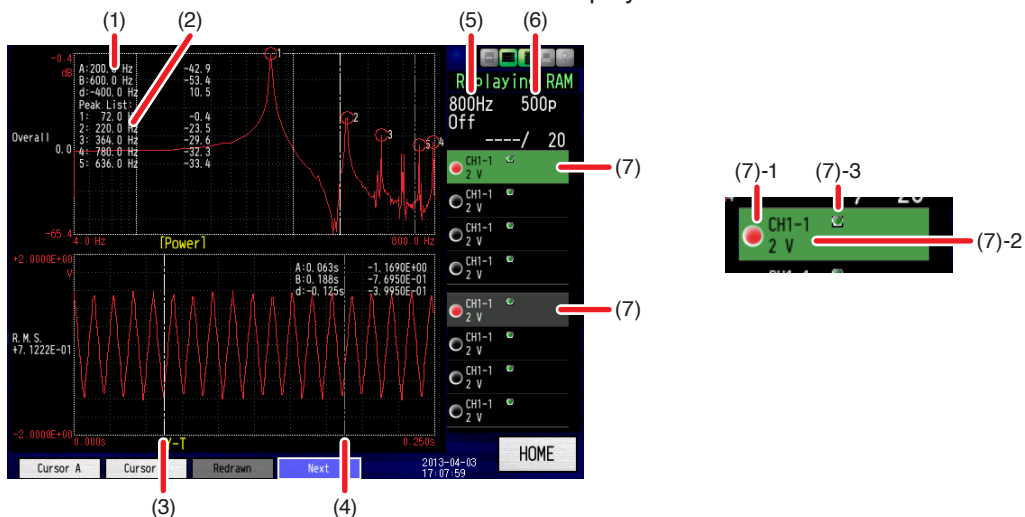

- (1) Cursor resulting data display: The data of A and B cursors, and difference data between A and B are displayed.
- (2) Peak List: The top five of the peak waveforms in the analysis results are displayed.
- (3) A cursor display
- (4) B cursor display
- (5) Analysis frequency display
- (6) Number of analysis points display
- (7) Green frame is the active zone. To activate the gray frame, touch the gray frame to switch to green.
 - (7)-1 When the trace starts, the red lamp for each CH is lit.
 - (7)-2 The set CH and range are displayed.
 - (7)-3 When the set range is other than Off, the green lamp is lit. When the value is scaled over, the red lamp is lit.

(15)-11 How to operate the FFT display

This section explains how to operate the FFT display screen.

FFT analysis is performed with the recorded data or the internal RAM operation.

For how to save the analysis result data, refer to "(17) Saving Data".

1. Analysis of recorded data

FFT analysis can be performed by reading the data recorded in Y-T mode, etc. in FFT display mode.

In the analysis, select the waveform to be analyzed with the cursor after Y-T replaying, and FFT calculation is performed for the data within the region.

For reading the data, refer to "(15) Replay setting screen (Data Replay screen)".

2. Direct FFT

When the analysis frequency is less than 400 Hz or the trigger is On (enabled) in the FFT Display Mode, the internal RAM is fixed, and when it is 400 Hz or more, the FFT analysis is displayed with the buffer memory function.

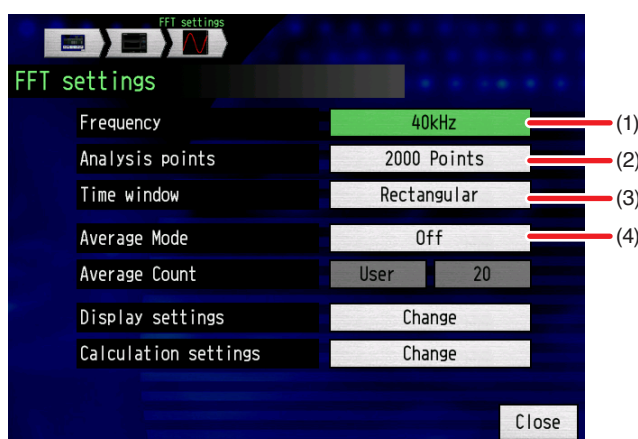

| Item select | Description |
|---------------------|---|
| (1) Frequency | The analysis frequency on X Axis can be set by selecting 0.08Hz to 400kHz analysis frequency. |
| (2) Analysis points | The number of recorded data in a single measurement can be determined by selecting the analysis points (500, 1000, 2000, 4000, 10000). |
| (3) Time window | The waveform is analyzed by selecting Rectangular, Hanning, Hamming, Blackman, Flattop or Exponential. |
| (4) Average mode | When Average mode is set to Summation, Exponential or Peak hold, the results processed with the average count are displayed. The resulting data is displayed superimposed in white. |

2-1. This section provides the descriptions of FFT setting.

<Setting procedure>

- (1) Set the Frequency range for analysis. The Range indicates the value of the maximum frequency. The frequency depends on the measuring module.

| Module name | Model | Frequency |
|----------------------------|---------|-----------|
| Voltage module | GL7-V | 400Hz |
| Voltage/Temperature module | GL7-M | 40Hz |
| High speed voltage module | GL7-HSV | 400kHz |
| High-voltage module | GL7-HV | 400kHz |
| DC strain module | GL7-DCB | 40kHz |
| Charge module | GL7-CHA | 40kHz |

- (2) The number of analysis points indicates the number of data to be measured. When the number of analysis points increases, the time of a single analysis is longer.
- (3) Determine how to analyze after setting the time window.
For more information on the main time window, refer to "2-2 Time window on page 3-126.

- (4) Set the number of measurement data processing.
When the averaging is off, the results of a single measurement is displayed.
When the averaging and the number of times are selected, the results are displayed superimposed according to the average processing times.
- (5) Set Display format, Function, X Axis, and Y Axis in FFT Display Setting screen.
- (6) When the above settings are completed, press the START key on this module. The results of FFT analysis are displayed.
The data is automatically recorded and analyze with the internal RAM.
- (7) Pressing the STOP key displays the last analysis results. You can confirm the detailed information using the cursor.

2-2. This section provides the descriptions of the Time window.

The input signal to be FFT analyzed is an infinite continuous signal, however only the signal within the finite time called Time window in infinitely continuous signal is subject to analysis. In FFT mode of the module, there is the following relationship to the time window length and analysis frequency.

$$\text{Time window length} = \frac{0.4}{\text{Frequency [Hz]}} \times \text{Number of analysis points [sec.]}$$

(The number of analysis points in FFT mode is 500, 1000, 2000, 4000, or 10000 points.)

<Rectangular>

No action is taken for the signal that is cut away with the time window. When the time window is used to cut the normal continuous waveform, the signal is affected by cutting with the Time window. However, when using the signal such that the length of waveform and time window match to an integer multiple of the period by attenuating within the time window, the result not affected by the time window can be obtained.

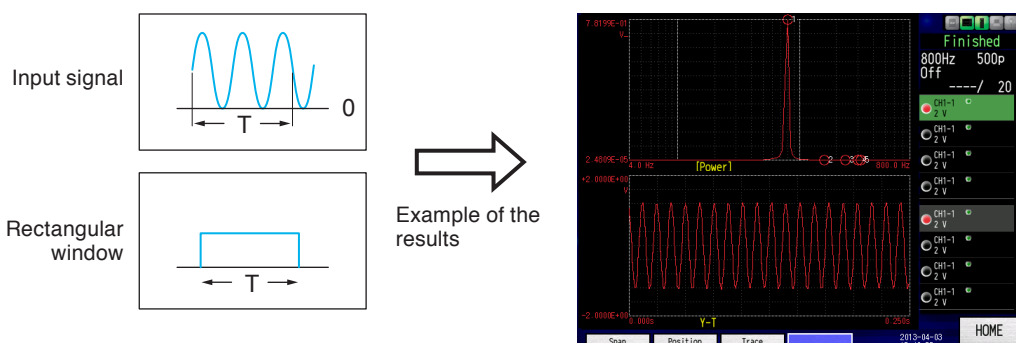

<Hanning>

The time window displays so that the input signal is zero smoothly at start and end points in consecutive. Since the input is zero at both ends of the time window, even if the continuous waveform is cut, the effects of the cut can be minimized.

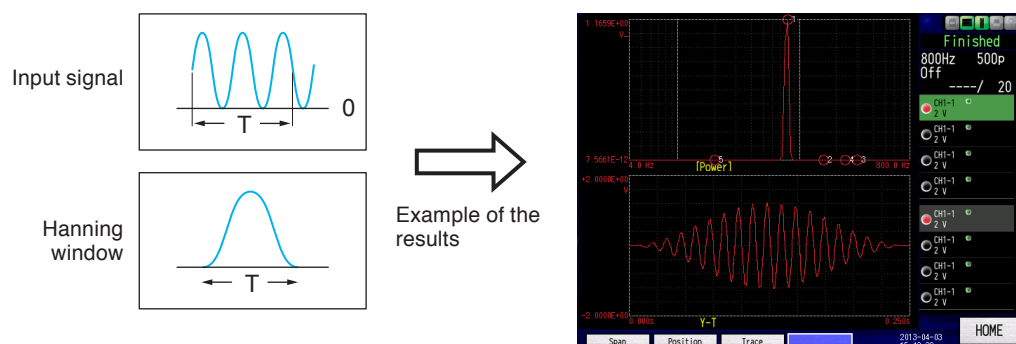

<Hamming>

The hamming window is suitable to separate the signals in close proximity in comparison to the hanning window.

Make an attempt to use the Hamming If you can not improve sufficiently the frequency resolution.

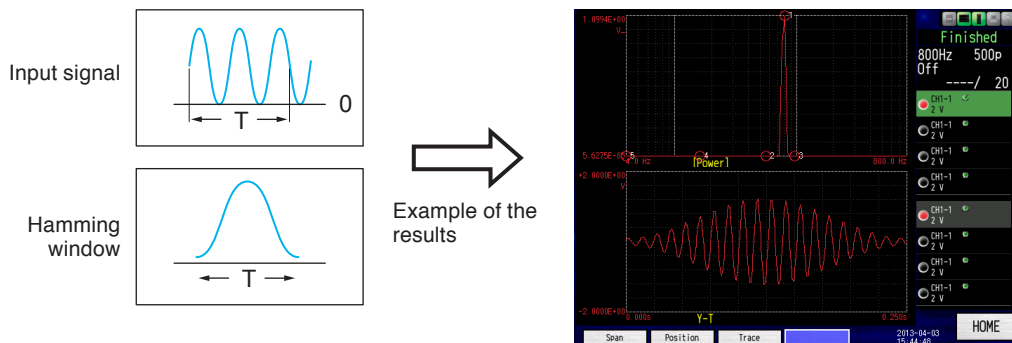

<Blackman>

The frequency resolution is lower than Hanning and Hamming, however even the smaller signal can be analyze because of a wider dynamic range.

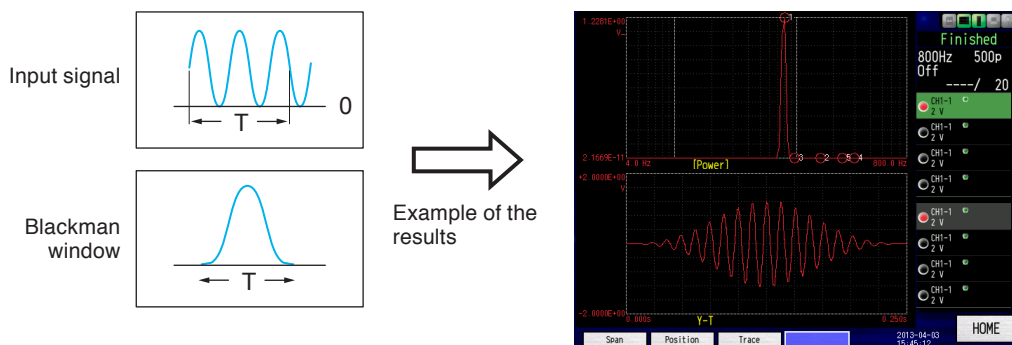

<Flattop>

The amplitude can be accurately measured by flattop the peaks with the low ripple time window function.

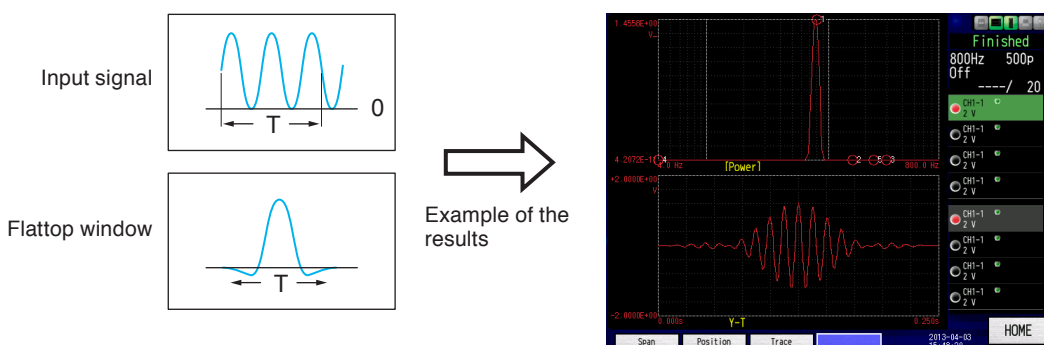

<Exponential>

Since this exponential is asymmetrical, it is used to perform the time asymmetric waveform analysis such as echo detection.

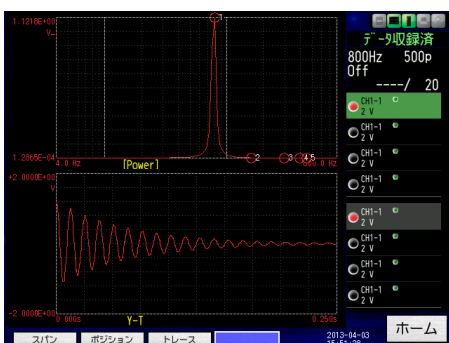

2-3. Averaging process

The noise component contained in the signal is removed by performing the averaging process.

Summation : The averaging process is performed depending on the number of measurements.

Exponential : With the progress of the Average count, the weight to be added is reduced.

Peak hold : The peak for each frequency is hold-processed in the specified number of times.

(16) Replay setting screen (Data relaying screen)

Selects the data for replay display.

("Home" → "Replay")

<In case of built-in RAM>

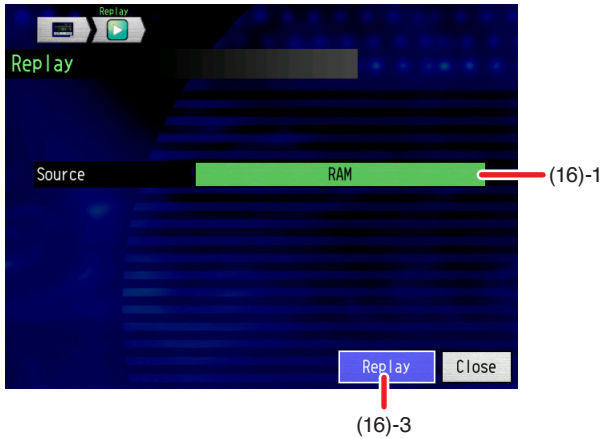

<In case of something other than built-in RAM>

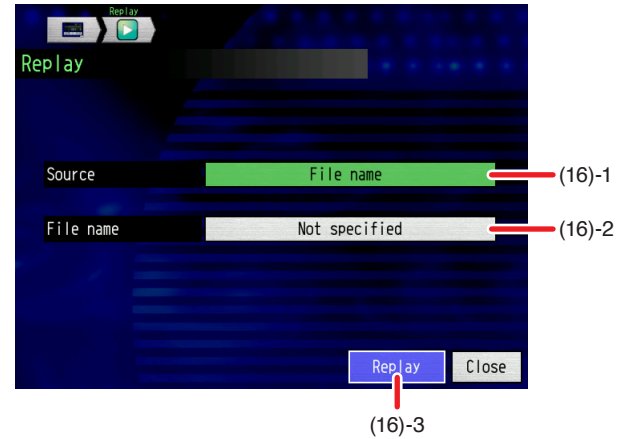

| Item select | | Description |
|-------------|-----------|---|
| (16)-1 | Source | Built-in RAM, File |
| (16)-2 | File name | File selection * The data recorded with CSV format cannot be replayed on the GL7000. |
| (16)-3 | Replay | ▷ Execute |

(16)-1 Source

Sets the replay source.

Set from files in the built-in RAM.

(16)-2 File name

Sets the file name to replay.

If the replay is a file, selects the file for playback display.

(16)-3 Replay

By pressing this button, the specified file is played and displayed on the screen.

(17) File operations

Contains operations such as file copy and folder creation. For operation methods related to file relations, refer to "(3) File operations" on page 3-28

("Home" → "File operation").

(18) Data Save

Saves the playback display data.

("Home" → "File" → "Data save")

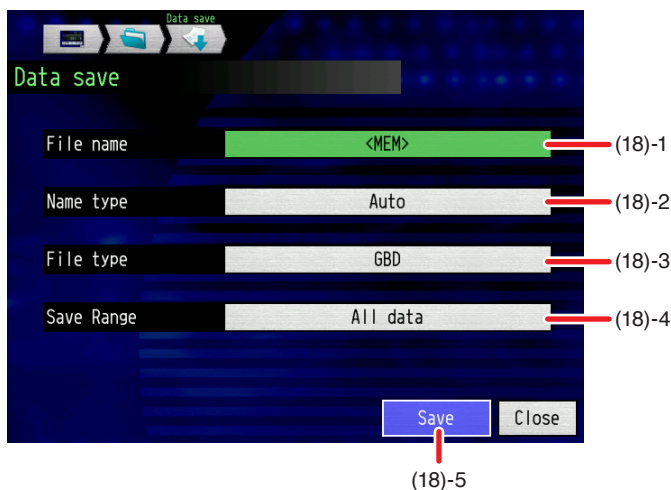

| Item select | | Description |
|-------------|------------|---|
| (18)-1 | File name | Select or enter the file name. |
| (18)-2 | Name type | Auto, User, Serial number |
| (18)-3 | File type | GBD, CSV *FFT analysis results is created with CSV format only. |
| (18)-4 | Save Range | All data, Data between cursors |
| (18)-5 | Save | ▷ Execute |

(18)-1 File name

Specifies the file name of the recording destination (or save destination). For details, refer to "(3) File operations" on page 3-28.

(18)-2 Name type

Sets how the data file is named.

Auto : The file is automatically named.
 <Ex.> 20120101-123456.GBD
 The numeric part... The day the file was created
 * E.g. 2012-01-01, 12:34:56
 GBD..... Data format
 GBD (Binary data)
 CSV (Text format)

User : Data is saved to a user-input file name.

Serial number : consecutive number is attached to the user-input file name to create the file name.

<Ex.> When the file name is "TEST"
 First : TEST_SER1.GBD
 Second: TEST_SER2.GBD
 Third : TEST_SER3.GBD

⚠ CAUTION

If the same file name already exists, it will be overwritten.

(18)-3 File type

Sets the data file format.

GBD : Data file created using our company's original binary format.

CSV : Data file created with the text format.

The FFT display data is saved in the file in CSV format only (not be selected) from the FFT result.

* It cannot be replayed on the GL7000.

(18)-4 Save Range

Sets the range of data to be saved.

All data: Regardless of the cursor location, saves all data.

Data between the cursors

: Cuts and saves only the area between both the A and B cursors.

* The measurement points data and results of the function operation and overall peak list are saved as the FFT data, regardless of the cursor operation.

(18)-5 Save

By pressing this button, data is saved according to the specifications.

(19) Save/Load current settings

Saves or loads and reflects the conditional settings of the GL7000.

("Home" → "File operation" → "Save/Lode current settings")

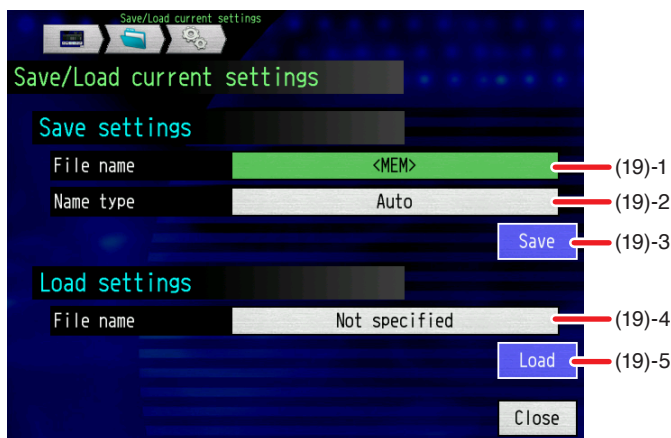

| Item select | | Examples of it | |
|-------------|---------------|----------------|---------------------------|
| (19)-1 | Save settings | File name | Text input |
| (19)-2 | | Name type | Auto, User, Serial number |
| (19)-3 | | Save | ▷ Execute |
| (19)-4 | Load settings | File name | Text input |
| (19)-5 | | Load | ▷ Execute |

CHECKPOINT

The following settings can not be saved.

- Display mode, Y-T trace setting, and Display format of the logger.
- Network settings, FTP server settings, and Network time settings.
- Recording destination, recording file name, auto save destination,
- AC line frequency, password for key-lock, and new-line characte.
- TEDS information (Please save when setting the strain or charge module)

(19)-1 File name

Specifies the file name in the settings save destination.

For details, refer to "(3) File operations" on page 3-28.

(19)-2 Name type

Sets how the data file name is attached.

Auto : The file is automatically named.
 <Ex.> 20120101-123456.CDN
 The numeric par....The day the file was created
 * E.g. 2012-01-01, 12:34:56
 CDN.....Data format (The file format set on the machine)

User : Creates a setting file with the user-input file name.

Serial number : Data is recorded to a file name from the input name.

CAUTION

If the same file name already exists, it will be overwritten.

(19)-3 Save

By pressing this button, settings are saved according to the specifications.

(19)-4 File name

Sets the file name of the set load source. For details, refer to "(3) File operations" on page 3-28.

(19)-5 Load

By pressing this button, data is, according to specifications, loaded reflecting settings.

CHECKPOINT 

GL7000 can not read the setting file that the module configuration is different.

(20) Swapping out the SD card

When the GL7000 is recording data to the SD card, the SD card can be swapped. Follow the operations below to implement the swap.

CHECKPOINT

This function can be used even if sampling rate is slower than 100 ms.

- (1) When data is being recorded, press the "HOME" key or "Home" displayed on the screen to open the home menu.



- (2) Press "Change SD card".

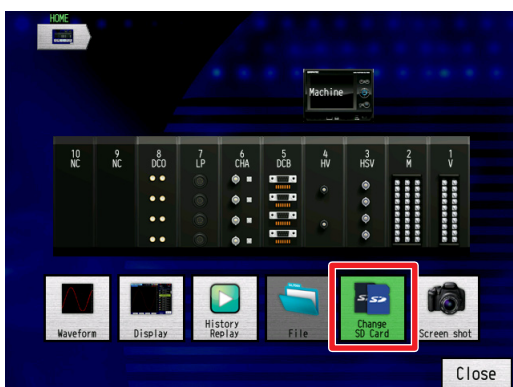

- (3) As the message appears, remove the SD card.

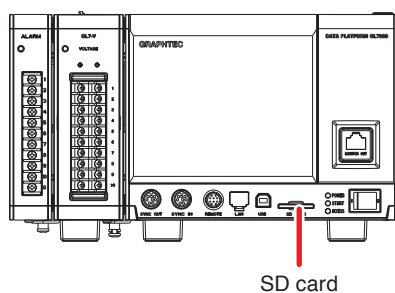
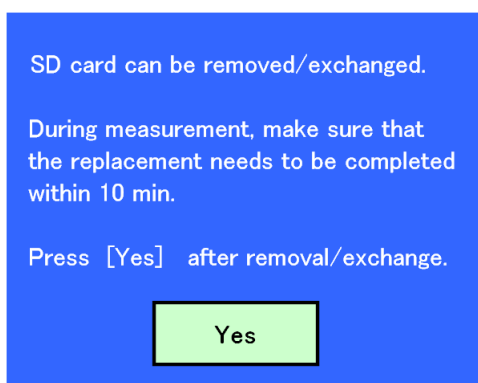

CAUTION

Please do not remove the SD card until this message appears. This can lead to data being damaged and/or becoming inaccessible.

- (4) Insert the new SD card.

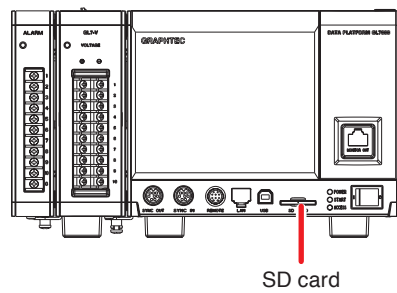
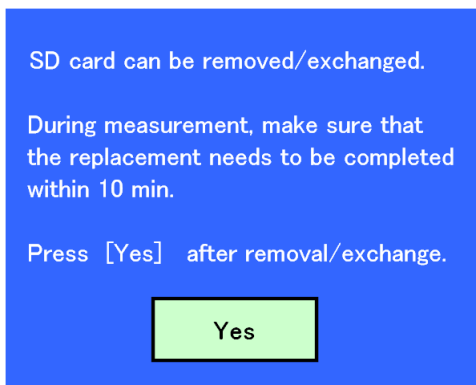

- (5) Press "Yes" displayed in the message or the "ENTER" key.

CHECKPOINT

- When swapping SD cards, _CHG[number] is added to the file name.
 <Ex.> When recorded with the file name "TEST.GBD"
 First SD card: TEST.GBD
 Second SD card: TEST_CHG1.GBD
 Third SD card: TEST_CHG2.GBD
- If ring capture is On, the SD card cannot be replaced.
- The GL7000 is compatible with SD and SDHC. (It is not compatible with SDXC.)

CAUTION

Please implement the swap within 10 minutes. If it exceeds 10 minutes, data loss may occur.

(21) Screenshot

Saves the replayed data as an image file.



| Item select | | Description |
|-------------|-----------|---------------------------|
| (21)-1 | File name | Text input |
| (21)-2 | Name type | Auto, User, Serial number |
| (21)-3 | File type | BMP, PNG |
| (21)-4 | Save | ▷ Execute |

(21)-1 File name

Sets the image file name to be saved. For details, refer to "(3) File operations" on page 3-28.

(21)-2 Name type

Sets how the image file name is attached.

Auto : The file is automatically named

<Ex.> 20120101-123456.BMP

The numeric part... The day the file was created

* E.g. 2012-01-01, 12:34:56

BMP Data format

BMP (Bitmap format)

PNG (Portable Network Graphics format)

User : The image is saved to a user-input file name.

Serial number : A consecutive number is attached to the user-input file name to create the file name.

⚠ CAUTION

If the same file name already exists, it will be overwritten.

(21)-3 File type

Sets the data file format.

Set from BMP, PNG.

(21)-4 Save

By pressing this button, the image file is saved according to specifications.

(22) Cursor position

Moves the cursor to a specified location.

<If cursor movement is positional>

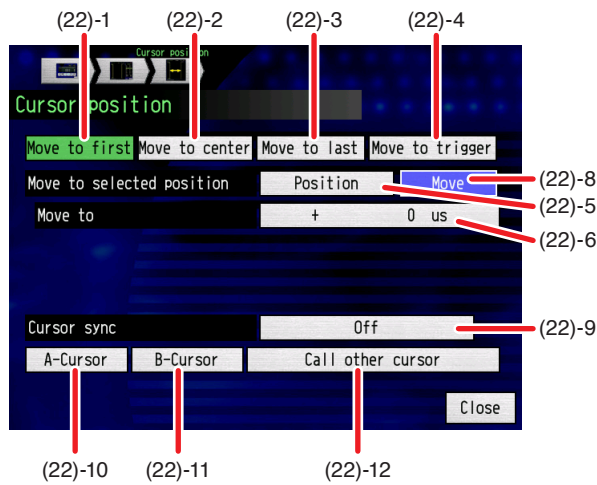

<If cursor movement is time based>

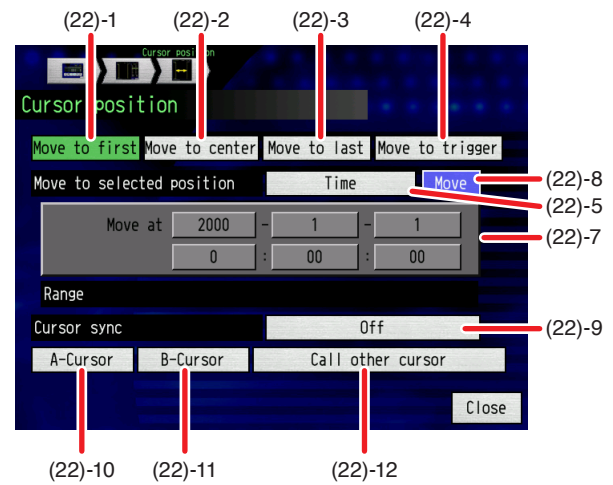

| Item select | | Examples of item | |
|-------------|---------------------------|------------------|----------------|
| (22)-1 | Move to first | ▷ | Execute |
| (22)-2 | Move to center | ▷ | Execute |
| (22)-3 | Move to last | ▷ | Execute |
| (22)-4 | Move to trigger | ▷ | Execute |
| (22)-5 | Move to selected position | | Position, Time |
| (22)-6 | | [Position] | Move to |
| (22)-7 | | [Time] | Move at |
| (22)-8 | Move | ▷ | Execute |
| (22)-9 | Cursor sync | | Off, On |
| (22)-10 | A-cursor | ▷ | Execute |
| (22)-11 | B-cursor | ▷ | Execute |
| (22)-12 | Call other cursor | ▷ | Execute |

(22)-1 Move to first

Upon execution, the currently selected cursor (A or B) moves to the top data.

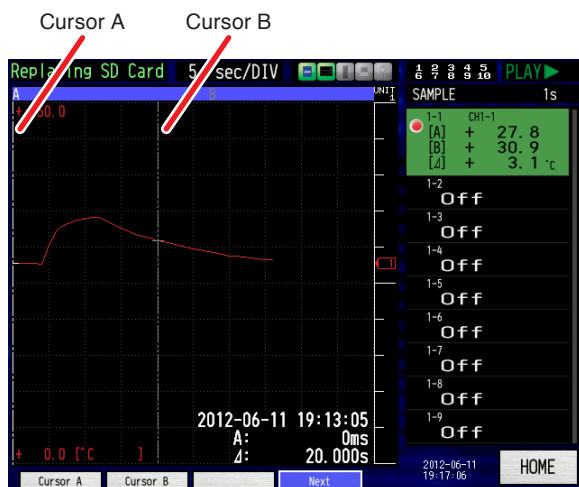

(22)-2 Move to center

Upon execution, the currently selected cursor (A or B) moves to the center data.

(22)-3 Move to last

Upon execution, the currently selected cursor (A or B) moves to the bottom data.

(22)-4 Move to trigger

Upon execution, the currently selected cursor (A or B) moves to the trigger point.

(22)-5 Move to selected position

Sets the movement destination selection method. Position and/or time can be set.

(22)-6 Move position

Sets the position of the movement destination. If the recording start is 0, it sets how much further the position should move. Can only be set at the final data point.

(22)-7 Move date/time

Sets the movement destination by date and time. Can only be set at the final data point.

(22)-8 Move

When executing, the currently selected cursor (A or B), moves to the desired position or desired date/time.

(22)-9 Cursor sync

When moving the cursor, sets the function for moving 2 at the same time.

| Item select | Description |
|-------------|---|
| Off | Only one specific cursor will move. |
| On | Moving 2 cursors synchronously. The fulcrum is already A. |

* Cursor synchronization functions are turned off when carrying out cursor movements such as movement to a selected position or data retrieval.

(22)-10 A-cursor

Upon execution, A cursor is selected.

(22)-11 B-cursor

Upon execution, B cursor is selected.

(22)-12 Call other cursor

Upon execution, the cursor not displayed (A or B) is moved to the center (the location where the data is) of the screen.

(23) Data search

Moves the cursor to the position that satisfies the set conditions.

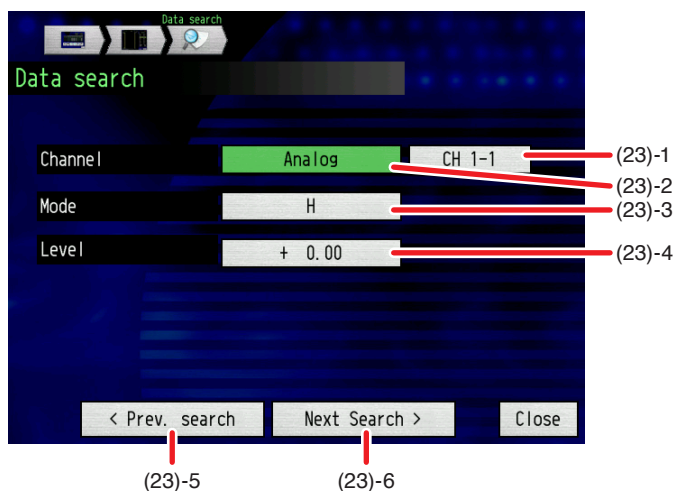

| Item select | | Examples of item | |
|-------------|--------------|--|------------|
| (23)-1 | Channel type | Analog, Pulse, Logic, Alarm | |
| (23)-2 | Channel | 1 to 112CH * This varies depending on the channel type. | |
| (23)-3 | Mode | [Analog] | H, L |
| | | [Pulse] | |
| | | [Logic] | Both, H, L |
| | | [Alarm] | |
| (23)-4 | Level | Numeric input | |
| (23)-5 | Prev. search | ▷ Execute | |
| (23)-6 | Next search | ▷ Execute | |

(23)-1 Channel type

Sets the channel type to search.

(23)-2 Channel

Sets which channel to use for searching. The only channels that can be set are the channels corresponding to the types selected in "(22)-1 Channel type".

(23)-3 Mode

<In case of Analogue/Pulse/Logic>

| Item select | Description |
|-------------|--|
| H | Captures the rising edge of a specified CH. |
| L | Captures the falling edge of a specified CH. |

<In case of alarm>

| Item select | Description |
|-------------|--|
| Both | Searches the alarm output either as it changes to established or cleared. |
| H | Searches the alarm output edge that changes from being cleared to being established. |
| L | Searches the alarm output edge that changes from being cleared to being established. |

(23)-4 Level

Specifies the retrieved voltage level when the searched channel type is analogue or pulse.

(23)-5 Prev. search

Upon execution, the cursor is moved to the position previous to the current position, and a position that satisfies the search conditions. (Please set the retrieval conditions in "(22)-3 Mode" and "(22)-4 Level".)

(23)-6 Next search

Upon execution, the cursor is moved to the position following the current position, and a position that satisfies the search conditions. (Please set the retrieval conditions in "(22)-3 Mode" and "(22)-4 Level".)

(24) Action screen

The recorded data can be saved and shown in the XY or FFT display.

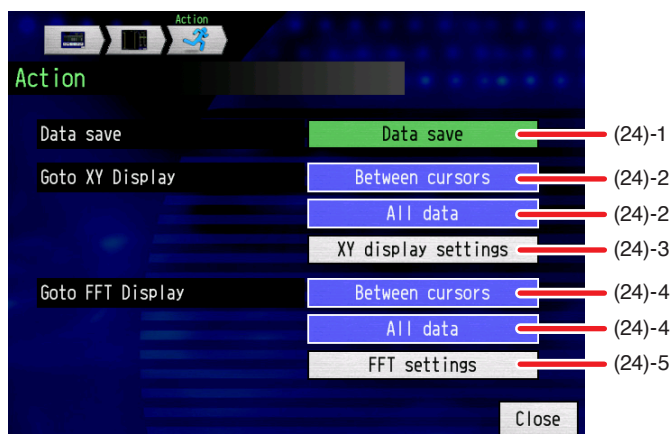

| Select items | Description |
|--------------|---|
| (24)-1 | Use the "Data save" to save the recorded data (See page 3-129). |
| (24)-2 | Use these buttons to display the Y-T display data between the cursors or all the data with the XY display (See page 3-115). |
| (24)-3 | Use the "XY display settings" to perform the XY display settings (See page 3-120). Always set them before X-Y display of the setting item (24)-2. |
| (24)-4 | Use these buttons to perform FFT analysis between the cursors or within the selected range of all the data (See page 3-124). |
| (24)-5 | Use the "FFT settings", perform the FFT settings (See page 3-124). Always set then before FFT analysis of the setting item (24)-4. |

* When you want to Y-T display after starting up the setting times (24)-2 and (24)-4, return to Action screen and then start up the "Goto XY Display"

(27) Output settings (DCO module settings)

Set the analog voltage output to the equipment to be received.

("Home" → "GL7000 setting" → "Data settings" → "Output settings" → "DCO module settings")

("Home" → "GL7000 setting" → "DCO module settings")

<Voltage Output Module (GL7-DCO)>

For the setting procedure for this module, refer to (4) Output settings in "3.6 Settings menu".

(The number in the following figure is expressed in the same number as the number of (4) Output settings in "3.6 Settings menu".)

<Output settings → DCO module settings>

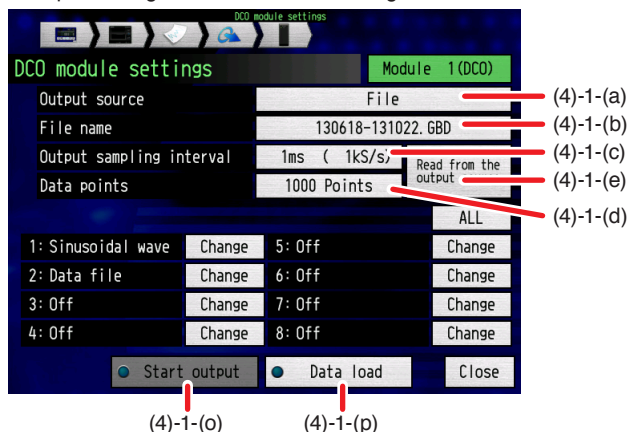

<When using Sine wave, Triangle wave, Ramp wave>



<When using Pulse wave>

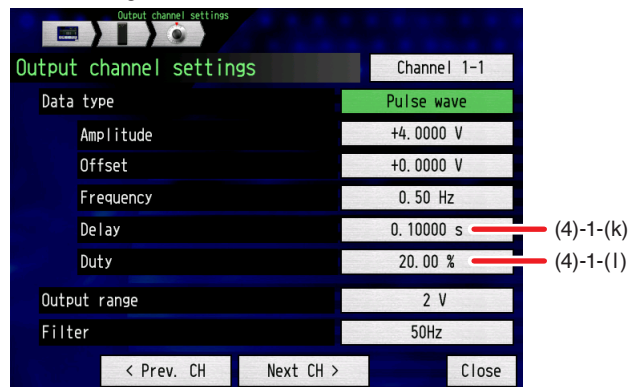

| Item select | | Examples of item | |
|-------------|-----|-----------------------------|--|
| (4)-1 | (a) | Output source | Built-in RAM, File |
| | (b) | File name | File selection |
| | (c) | Output sampling interval | 10ms (100kS/s), 20ms (50kS/s), 50ms (20kS/s), 100ms (10kS/s), 200ms (5kS/s), 500ms (2kS/s), 1ms (1kS/s), 2ms (500S/s), 5ms (200S/s), 10ms (100S/s), 20ms (50S/s), 50ms (20S/s), 100ms (10S/s), 125ms (8S/s), 200ms (5S/s), 250ms (4S/s), 500ms (2S/s), 1s (1S/s), 2s, 5s, 10s, 20s, 30s, 1min, 2min, 5min, 10min, 20min, 30min, 1h |
| | (d) | Data points | 1 to 128,000,000 points |
| | (e) | Read from the output source | Reading the file data conditions |

| Item select | | Examples of item | |
|-------------|------------------------------|---|---|
| (f) | Setting (ALL, 1CH to 8CH) | Data type | Off, Data file, DC, Sine wave, Triangle wave, Ramp wave, Pulse wave |
| (g) | | Amplitude | 0.000 to +20.000V |
| (h) | | Offset | -10.000 to +10.000V |
| (i) | | Frequency | 0.00 to 10,000.00Hz |
| (j) | | Phase | -360.0 to +360.0deg. |
| (k) | | Delay | 0.00000 to 100.00000sec. |
| (l) | | Duty | 0.00 to 100.00% |
| (m) | | Output range | 1, 2, 5, 10V |
| (n) | | Filter | Off, Line, 5 / 50 / 500Hz, 5 / 50kHz |
| (o) | Data load | Reading the analog voltage output data and conditions | |
| (p) | Start output | Analog voltage output start / output stop | |

⚠ CAUTION

Before operating the Start output, the following setting conditions must be set on the Output settings screen. (For details, refer to (4) Start output in "3.6 Settings menu" on page 3-58.)

- Start / Stop synchronization
- Repeat output
- Emergency stop alarm CH
- Output level at the time of Stop

When the Output level at the time of Stop is set to "Retain", the voltage value at the time of stop is output.

3.7 Web server functions

Operation and monitoring of the GL7000 can be done with a web browser.

• Supported web browsers

- Microsoft Internet Explorer 6.0 or later
- Netscape 6.2 or later
- Firefox 1.5 or later
- Opera 9.0 or later

• Functions carried out through web browsers

- Operating of GL7000
- Monitoring of GL7000's screen
- Magnified view of GL7000's display screen
- Link to the FTP
- Link to our website

• URL settings

Set the URL (Uniform Resource Locator) appropriately, according to the network environment in use. By setting as follows, the GL7000 can be accessed.

http://IP address/index.html

- http Protocol for accessing the server.
HTTP (Hyper Text Transfer Protocol)
- IP address Input the address of the monitoring GL7000
- index.html A file name. It's fixed as index.html

CHECKPOINT

- The port number can be omitted. If inputting, please set it to 80.
http://IP address:80/index.html
- WEB connections from multiple browsers can not occur. Please use 1 browser connection for each machine.

• Operation procedure

- (1) Start a web browser

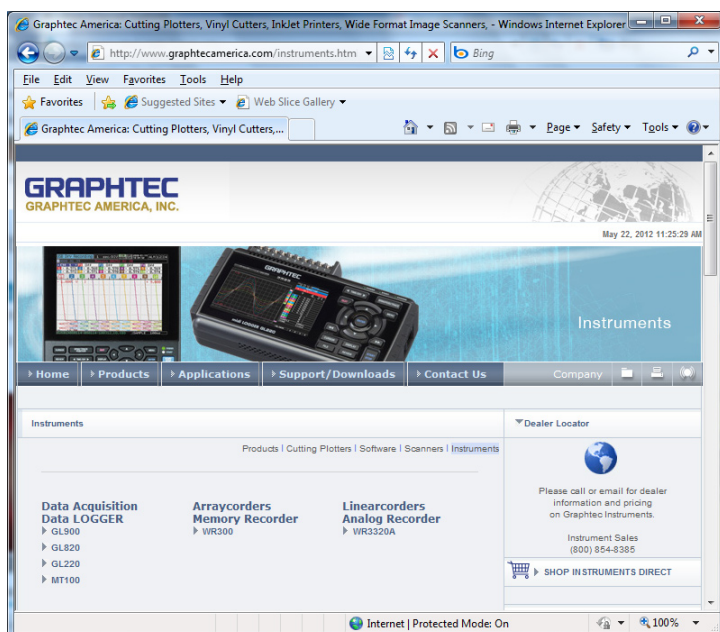

(2) Type in an URL (http://IP address/index.html) in the address field.

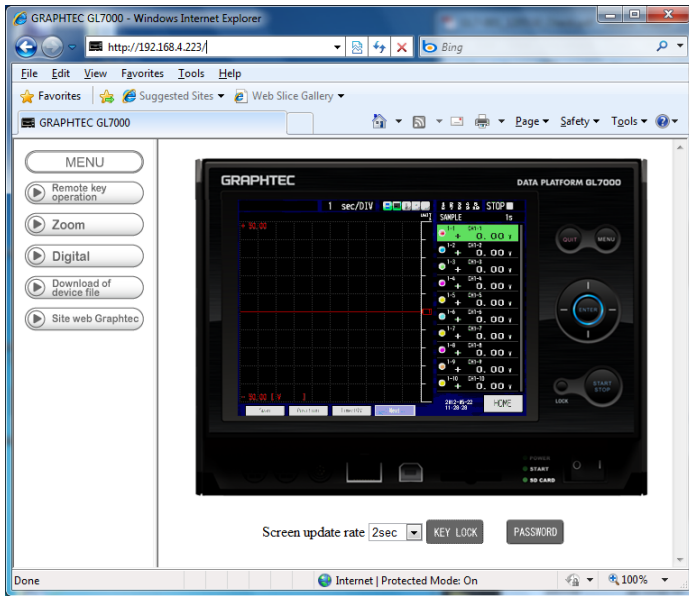

Remote key operation....GL7000 operations can be performed.

Zoom.....Only for zooming in on the LCD screen of the GL7000.

Digital.....Digital display of the GL7000 measurement value.

Download of device file

.....Using the FTP function to download data recorded with the GL7000 to the PC.

Site web GraphtecLinks to our company's homepage.

• Remote operations

The GL7000 can be remotely operated by clicking on the GL7000 operation key part or the button on the screen.



KEY LOCK.....Carries out key-lock and clears it.

PASSWORDClears password settings.

Screen update rateSets the refreshing rate of the screen.

The screen refresh rate can be set to 2, 5, 10 seconds.

• Screen display



Screen update rateSets the refreshing rate of the screen.
The screen refresh rate can be set to 2, 5, 10 seconds.

• Digital screen

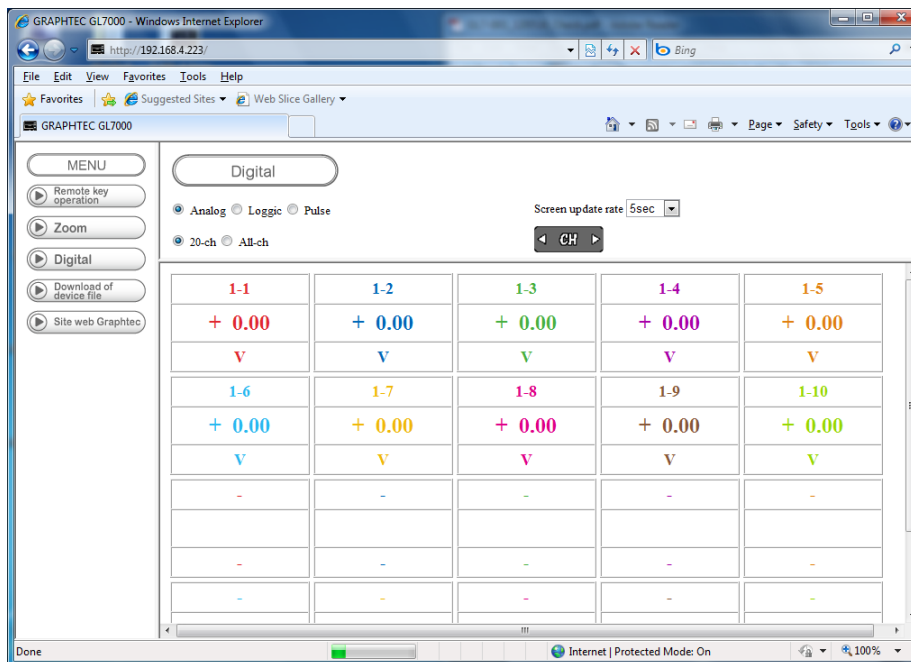

Screen update rateSets the refreshing rate of the screen.
The screen refresh rate can be set to 2, 5, 10 seconds.

- **Downloading GL7000 files**

GL7000 memory data, SD card data, and SSD data can be downloaded to PC.

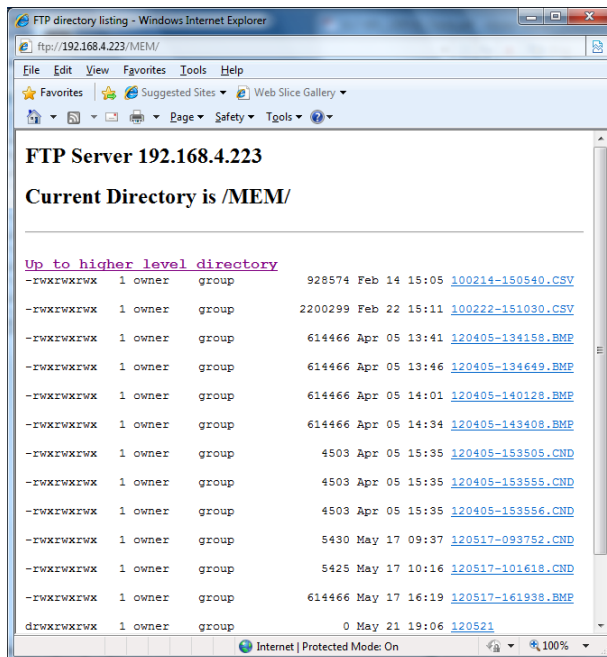

<FTP server functions>

When connection to FTP with Internet Explorer, because you're automatically logged in as anonymous it's limited to read-only.

When limited to read-only, the following operations can not be performed.

- Upload data
- Delete files/folders
- Create files/folders
- Change File name/folder name

For writing to the GL7000, the login account must be changed.

For account name and password, refer to the following.

| Account name | Password | Restrictions |
|--------------|----------|--------------|
| GL7000 | N/A | N/A |
| gl7000 | N/A | N/A |
| Anonymous | Optional | Read-only |

For updating the login account, perform the following operations.

<When using Internet Explorer 6>

Open the "Log On As" dialogue via "File" → "Login As..."

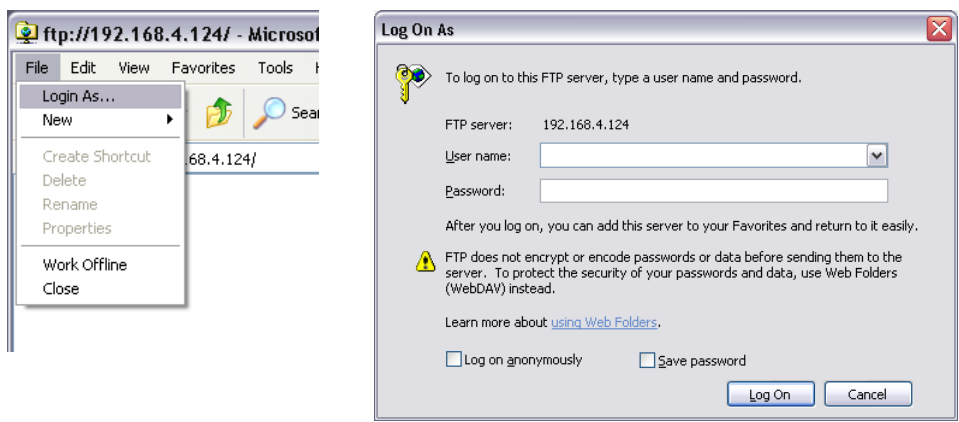

Input the account name in user name field. Leave the password field blank. Finally, press the "Log on" button.

<When using Internet Explorer 8>

Open Internet options via "Tools" → "Internet Options".

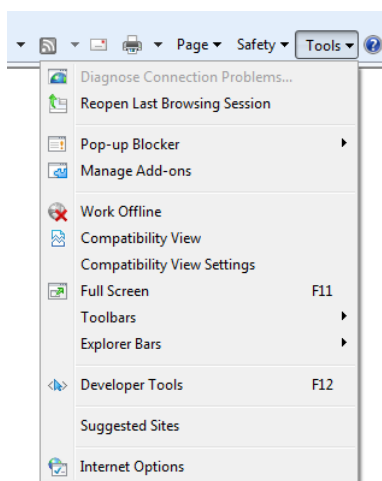

Select "Advanced" tab and check "Enable FTP folder view (Outside Internet Explorer)"

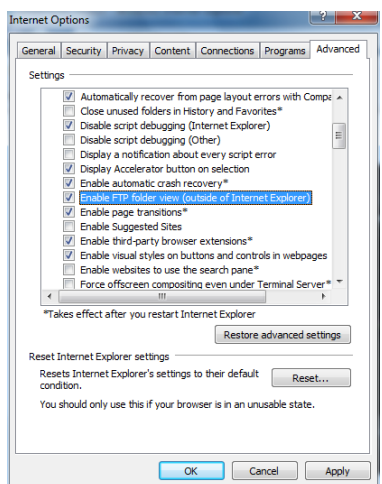

Press the "OK" button to close the Internet option dialogue.
Close Internet Explorer.

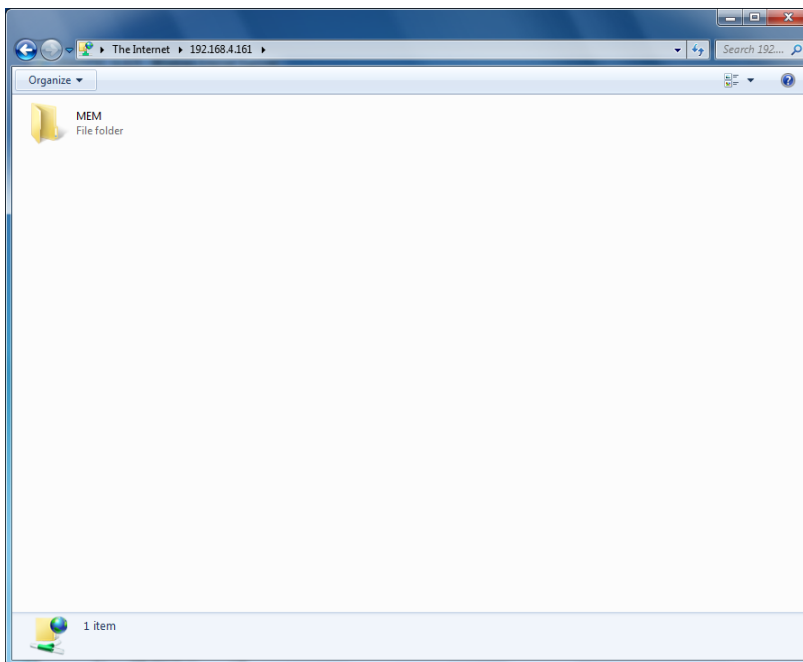

Open the "Log On As" dialogue via "File" → "Login As...".

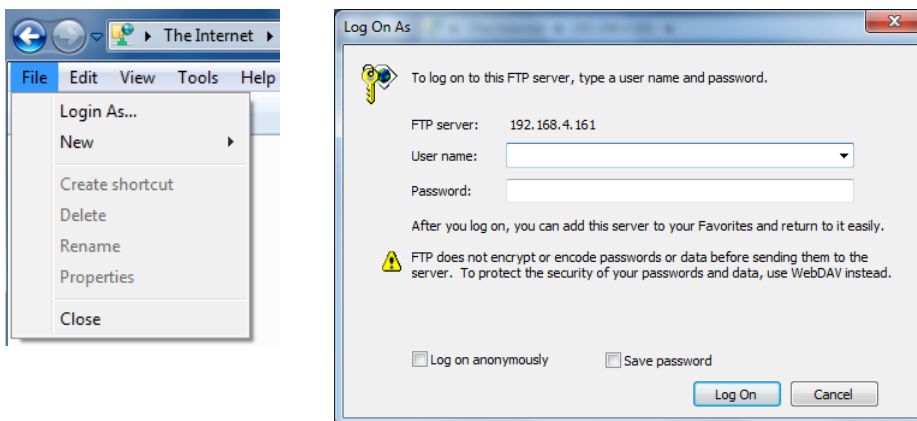

Input the account name in user name field. Leave the password field blank.
Finally, press the "Log On" button.

CHECKPOINT

If the "File" menu is not displayed in Explorer, check "Edit" → "Layout" → "Menu bar" to display the menu.

CHAPTER 4 Specification

This chapter describes the basic specifications for the GL7000.

- 4.1 Standard Specifications
- 4.2 Function Specifications
- 4.3 Function Module Specifications
- 4.4 Amplifier Module Specifications
- 4.5 Accessory/Option Specifications
- 4.6 Accessories
- 4.7 External view

4.1 Standard Specifications

Standard Specifications

| Item | Description |
|---|---|
| Number of Amplifier Modules | Max. 10 modules * The DC strain module can be installed up to 8 modules. * Function Modules like the Display Module and the SSD Module are not included in the 10 Modules mentioned above. * The Logic/Pulse amplifier can be set to either logical amplifier or pulse amplifier. The pulse amplifier can only be set for up to 2 modules (16ch/1 module). |
| External input/output | Start/Stop input, External trigger input, External sampling input, Trigger output. * When using the external input/output function, the I/O cable B-513 (optional) for GL series is required. |
| Alarm input/output | 10ch * The Alarm Module is a separate module from the main module. |
| PC I/F | Ethernet (10BASE-T/100BASE-TX), USB2.0 (compatible with high-speed), standard-included |
| Internal memory device | Built-in flash memory: approx. 2GB or more * The built-in RAM is equipped with standard in each Amplifier Module, which can be stored 2,000,000 data. Synchronization function is available in GL-Connection only. |
| External memory device | SD card (SDHC equivalent, maximum approx. 32GB) slot standard-included |
| Backup function | Setting Conditions: EEPROM/Clock: Lithium secondary battery |
| Clock accuracy (23°C environment) | ±0.002% (Lunar equation: approx. 50 seconds) |
| Synchronization between measurement modules | With Start and Trigger synchronizing functions * When using the synchronizing function, the optional coaxial cable B-559 is required. The synchronizing function is available in the GL-Connection only. |
| Time base accuracy | ±100ppm (23°C±2°C) |
| Usage environment | 0 to 45°C, 5 to 85% R.H. |
| Withstand voltage | Between AC power and housing: 1500 VAC at 1 minute |
| Insulation resistance | Between AC power and housing: 500 VDC at 20MΩ or more |
| Power supply | AC input: 100 to 240 V AC/50 to 60Hz |
| Power consumption | 85 VA |
| External dimension (approx.) [W × H × D] | Main modle: 193 × 141 × 160 mm (not including protruding parts) Alarm Module: 30 × 136 × 145 mm (not including protruding parts) |
| Weight (approx.) | Main modle: 2.2 kg Alarm Module: 350 g |
| Others | Vibration proof: Automobile parts Type 1 Class A equivalent |

Internal memory devices

| Item | Description |
|-----------------|--|
| Memory capacity | Built-in RAM: SD-RAM, 2,000,000 data (equipped with each Amplifier Module) SSD* ¹ : approx. 64GB (However, one file must be 2GB at the maximum) Built-in flash memory: Flash memory, 2GB or more (However, one file must be 2GB at the maximum.) SD card: Compatible with SDHC, maximum approx. 32GB (However, one file must be 2GB at the maximum) * Depending on the recording destination there is a limit to the sampling interval. |
| Memory contents | Built-in RAM: Measured data SSD* ¹ : Measured data, main module setting Conditions, Screen copy Built-in flash memory: Measured data, main module setting Conditions, Screen copy SD card: Measured data, main module setting Conditions, Screen copy |

*1: SSD Module (sold separately), GL7-SSD (optional) are required.

There is a limit to the highest sampling rate can be set for the number of modules to be used.

When setting the sampling interval to 1 μ s or 2 μ s, there is a limit to the number of pulse input channels. (For details, see "(1)-1 Sampling Interval" in page 3-49.)

PC I/F

| Item | Description |
|---|--|
| Interface types | Ethernet (10BASE-T/100BASE-TX) USB (High-speed) |
| Software functions | Data transfer to the PC (real-time memory) PC control of the main module |
| Ethernet functions (10BASE-T/100BASE-TX) | Web server functions: Displays the screen images of main module FTP server functions: SSD* ¹ , Built-in flash memory, Transfers and deletes files from the SD card memory. FTP client functions: Backup captured data to FTP server NTP client functions: Time synchronization with the NTP server. DHCP client functions: IP address automatic acquisition |
| USB functions | USB drive mode: SSD* ¹ , Built-in flash memory, Transfers and deletes of files from the SD card memory. * By flipping the machine slide switch, or turning on the power while pressing the [Start/ Stop] key on the Display Module, it goes into USB Drive Mode. |
| Real-time data transfer speed* ² | 1 msec/10ch fastest |

*1: SSD Module (sold separately), GL7-SSD (optional) are required.

*2: This depends on the number of transferred CH.

Trigger and Alarm functions

| Item | Description |
|------------------------------|---|
| Repeat Trigger | OFF, ON |
| Trigger types | Start : Data capture starts when a trigger is generated. Stop : Data capture stops when a trigger is generated. |
| Trigger conditions | Start : Off, Level, Alarm, External, Time, Date, Weekly Stop : Off, Level, Alarm, External, Time, Date, Weekly |
| Level trigger judgment modes | Combination : Level OR, Level AND, Edge OR, Edge AND Analog channel judgment mode : H (↑), L (↓), Window In, Window Out Logic channel judgment mode : H (↑), L (↓) Pulse channel judgment mode : H (↑), L (↓), Window In, Window Out |
| Alarm judgment modes | Detection method : Level OR, Level AND, Edge OR, Edge AND Analog channel judgment mode : H (↑), L (↓), Window In, Window Out Logic channel judgment mode : H (↑), L (↓) Pulse channel judgment mode : H (↑), L (↓), Window In, Window Out Detection cycle Voltage/Temperature amplifier : when the sampling speed is 5 seconds or more, the alarm is detected in 5 second intervals. When the sampling interval is less than 5 seconds, the alarm is detected at the sampling speed. Other amplifiers : The sampling rate is detected in 1 ms intervals for less than 1 ms. The sampling rate is detected in sampling rate between 2 ms and 5 sec. The sampling rate is detected in 5 sec. intervals for 5 sec. or more. |
| Pre-trigger | Number of specified points: 0 to the number of recordings. * This function is only possible when the recording destination is the built-in RAM. * Depending on the trigger combination, there may be cases where the pre-trigger cannot be used. |

Various functions

| Item | Description |
|------------------------------|--|
| Display | Analog waveforms, logic waveforms, pulse waveforms, digital values |
| Display modes | Y-T View (Digital display), X-Y View (Digital display), FFT View, Cursor Information View, Recorded Data View, Alarm Information View |
| EU (Scaling function) | Analog ch (Voltage Channel) : Each ch, 4-point setting Analog ch (temperature ch) : Each ch, 2-point setting (offset setting) Pulse ch : Each ch, 2-point setting (gain setting) Characters available : Alphabet, numbers, and other (μ and ε , etc.) |
| Calculation between Channels | Calculation type : Addition, subtraction, multiplication, and division Input target : Analog channels 1 through 100 Output target : Analog channels 1 through 100 * The fastest sampling interval that can be used for the Calculation between Channels function is 100 ms. |
| Statistical calculation | Types of operation : Average value, peak value, maximum value, minimum value Number of operations : maximum of 2 can be set simultaneously Calculation method : Real-time calculation and calculation between cursors (during replay) * Real-time calculation results are displayed in the Digital + Calculation Display screen. |
| Move functions | Type of moving : Move to first, Move to last, Move to center, Move to trigger, Move to selected position, Call other cursor. |
| Search functions | Function : Search the captured data for the required number of points Search Channel : Analog, Pulse, Logic, Alarm |
| Annotation input function | Function : A comment can be input for each channel Inputtable characters : Alphanumerics Number of characters : 31 half-width characters |
| Message/Marker functions | Function : The registered messages are recorded for any timing. Number of registration messages: Max. 8 Message : Unspecified message is input before or during recording Marker : alarm, blackout |
| Resume functions | Function : If the power goes off and is returned during data recording, recording will start again from the conditions that were present before the power went off. When GL7000 is in FFT mode or the Voltage Output Module is used, this function is not enabled. Users must be operated manually in each case. |
| FFT function | Analysis frequency : 0.08, 0.2, 0.4, 1.6, 2, 3.2, 4, 8, 2, 40, 80, 200, 400, 800Hz, 2, 4, 8, 20, 40, 80, 200, 400kHz Number of analysis points : 500, 1000, 2000, 4000, 10000 Time window : Rectangular, Hanning, Hamming, Blackman, Flattop, Exponential Average mode : Summation, Exponential, Peak hold Analysis CH : 4-ch Analysis function : Y-T, Linear, Power, PSD, Cross, TRF, Coherence, COP Display : 1-divided, 2-divided, Nyquist |

External Input/Output functions

| Item | Description |
|-----------------------------|--|
| Input/output types | <ul style="list-style-type: none"> • Start/Stop input (1ch) • External trigger input (1ch) • External sampling input (1ch) • Trigger input (1ch) • Alarm output (10ch) • Auto-balancing input (1CH) • BUSY signal output (1CH) <p>* The Start/Stop input is performed at a level action.</p> <p>* For input/output other than alarm output, the output cable B-513 (optional) for GL series is necessary.</p> <p>* The alarm output is attached to the included Alarm Module.</p> <p>* When the DC strain module is installed, the auto-balancing input and BUSY signal output are performed.</p> |
| Input specifications | <p>Max. input voltage : 0 to +24 V (single-ended ground input)</p> <p>Input signal : Non-voltage contact (a contact, b contact, NO, NC), Open collector, Voltage input</p> <p>Input threshold voltage : approx. +2.5 V</p> <p>Hysteresis : approx. 0.5 V (+2.5 to + 3 V)</p> <p>* For more information about the output circuit, see page 2-46.</p> |
| Alarm output specifications | <p>Output form: Open collector output (pull-up resistance 10kΩ)</p> <p><Maximum rating of the output transistor></p> <ul style="list-style-type: none"> • Voltage between collector and GND : 50 V • Collector current : 2.0 A • Collector dissipation : 0.6 W <p>* This specification is a maximum rating of the transistor used in the output circuit. When using this, ensure that the margin is sufficient.</p> <p>For details on the output circuit, see page 2-46.</p> |
| External sampling input | <p>Max. input frequency</p> <p>Built-in RAM : 1 MHz</p> <p>SSD*¹ recording : 1 kHz</p> <p>Built-in flash memory recording : 1 kHz</p> <p>SD card recording : 1 kHz</p> <p>Temporal error : Depending on each amplifier specifications</p> <p>* Until the maximum sampling interval is reached for each amplifier errors may appear.</p> |

*1: SSD Module (sold separately), GL7-SSD (optional) are required.

There is a limit to the highest sampling rate can be set for the number of modules to be used.

When setting the sampling interval to 1 μs or 2 μs, there is a limit to the number of pulse input channels. (For details, see "(1)-1 Sampling Interval" in page 3-49.)

Synchronization function

| Item | Description |
|---------------------------|---|
| Synchronization function | <ul style="list-style-type: none"> • Synchronizes the Start/Stop, trigger, and sampling between multiple units. • By connecting a sync cable, Master/Slave is automatically identified. • Part of the function for the Start/Stop switch and trigger combination etc. are only valid for the master unit. • The number of Amplifier Modules that can be connected to the master and slave unit conform to the basic specifications. |
| Number of synchronization | Max. 5 units |
| Cable | Sync cable, B-559 (optional) |

* Synchronization function is available in GL-Connection only.

4.3 Function Module Specifications

Display Module (GL-DISP: optional)

| Item | Description |
|---|--|
| Monitor | 5.7" TFT color liquid crystal display (VGA: 640 × 480 dot) |
| Operating portion | Capacitive touch-panel and key shared use * Almost all operations can be performed by either the touch-panel or the keys. |
| Touch-panel | Input method: Finger or "electrostatic" special pen |
| Display character | Japanese, English, French, German, Chinese, Korean |
| Backlight life | 50,000 hours (when brightness has decreased to 40%), changes according to use environment. |
| Backlight | Screen saver function (10, 30 sec.; 1, 2, 5, 10, 30, 60 min.) |
| Display screen | Waveform + digital screen, full waveform screen, digital + operation screen, X-Y display |
| Connection cable | LAN cable (Straight, CAT5 or above, Cable length:10 m or less) * Please purchase a commercially available product. |
| Accessories | Tilting table: 1 unit, Monitor connection cable (40 cm): 1 pc., Screws (M4 × 6): 3 pcs. Flat head screws (M4 × 10): 2 pcs. (Spare), Ground cable: 1 pc. |
| External dimensions (approx.) [W × D × H] | 187 × 34.5 × 119 mm (Not including protruding parts) |
| Weight (approx.) | 530 g |

* Since the touch-panel in this main module is a capacitive touch-panel, it does not respond by touching it with a pen. Touch with your fingers without glove.

* Please note that if the touch-panel is operated with an object with a sharp edge, it may scratch and damage the touch-panel.

* Do not touch when your hands are wet.

SSD Module (GL7-SSD: optional)

| Item | Description |
|---|---|
| SSD | 2.5-inch SSD HDD (SATA I/F) |
| Recording capacity | Approx. 64GB (However, 1 file can be up to 2GB in size) |
| Sampling interval | Module 1 to 2 : 1 μsec fastest Module 3 to 4 : 2 μsec fastest Module 5 to 10: 5 μsec fastest * Depending on the amplifier in use, there may be limitations to the sampling interval. It is limited to the furthest amplifier in use. * There is a limit to the highest sampling rate can be set for the number of modules to be used. When setting the sampling interval to 1 μs or 2 μs, there is a limit to the number of pulse input channels. (For details, see "(1)-1 Sampling Interval" in page 3-49.) |
| External dimensions (approx.) [W × D × H] | 49.2 × 136 × 160 mm (Not including protruding parts) |
| Weight (approx.) | 770 g |
| Vibration proof | Automobile parts Type 1 Class A equivalent |

4.4 Amplifier Module Specifications

Voltage Module (For voltage measurement) (GL7-V: optional)

| Item | Description |
|--|--|
| Number of input channels | 10 channels/1 module |
| Input terminal shape | M3 screw type terminal |
| Input method | All-ch insulation, simultaneous sampling, unbalanced input |
| Sampling interval | 1 ms fastest |
| Built-in RAM | 2,000,000 data |
| Measurement range | Voltage: 100, 200, 500 mV, 1, 2, 5, 10, 20, 50, 100, 1-5V.F.S. |
| Measurement accuracy (23 ±5°C) • 30 minutes or more after power-up • Filter Line • GND connection | Voltage: ±0.25% of F.S. |
| A/D converter | System : Sequential comparison system Resolution: 16-bit (Effective ability: approximate ± range 1/40,000) |
| Temperature coefficient | Gain: ±0.01% of F.S./°C Zero: ±0.02% of F.S./°C |
| Input resistance | 1 MΩ ±5% |
| Input signal source resistance | 1 kΩ or less |
| Maximum input voltage | Input terminal +/- interval: 100 mv to 1 V range → 60 Vp-p : 2 V to 100 V range → 100 Vp-p Input terminal (-)/Input terminal (-) interval : 60 Vp-p Input terminal (-)/GND terminal interval : 60 Vp-p * For details, see page 2-30. |
| Withstand voltage | Input terminal (-)/Input terminal interval : 1000Vp-p for 1 minute Input terminal (-)/GND terminal interval : 1000Vp-p for 1 minute * For details, see page 2-30. |
| Insulation resistance | Input terminal (-)/GND terminal interval: 50 MΩ or more (at 500 VDC) |
| Common mode rejection | 90 dB or more (50/60 Hz signal source 300 Ω or less) |
| S/N (Noise) | 48 dB or more (+/- at short) |
| Frequency response | DC to 1 kHz (+1, -3 dB) |
| Filter | L.P.F. : OFF, Line (1.5 Hz), 5 Hz, 50 Hz, 500 Hz Attenuation: -3 dB (-5.2 dB to -1.4 dB)/6 dB oct |
| External dimensions (approx.) [W × D × H] | 49.2 × 136 × 160 mm (Not including protruding parts) |
| Weight (approx.) | 840 g |

Voltage/Temperature Module (For temperature measurement) (GL7-M: optional)

| Item | Description | | | | | | | | | | | | | | | | | | | | | | | | | | | | | | | | | | | | | | | | | | | | | | |
|--|--|--|------------------------------------|----------------------|-----|---|--|---|--|--|---|---|--|---|--|--|---|--|--|---|--|---|---|---|--|---|---------------------------------------|--|--|--|--------|-------|------------------------------------|-------------------|----------------------|-------|-----------------------------|------|--------|--------|----------------------------|------|--------|--------|----------------------------|--------|--------|
| Number of input channels | 10 channels/1 module | | | | | | | | | | | | | | | | | | | | | | | | | | | | | | | | | | | | | | | | | | | | | | |
| Input terminal shape | M3 screw type terminal | | | | | | | | | | | | | | | | | | | | | | | | | | | | | | | | | | | | | | | | | | | | | | |
| Input method | All-ch insulation, Scan method, Balanced input * All CH of the b terminal used when using the resistance bulb are all connected internally. | | | | | | | | | | | | | | | | | | | | | | | | | | | | | | | | | | | | | | | | | | | | | | |
| Sampling interval | 10 ms fastest | | | | | | | | | | | | | | | | | | | | | | | | | | | | | | | | | | | | | | | | | | | | | | |
| Built-in RAM | 2,000,000 data | | | | | | | | | | | | | | | | | | | | | | | | | | | | | | | | | | | | | | | | | | | | | | |
| Measurement range | <ul style="list-style-type: none"> Voltage: 20, 50, 100, 200, 500 mV, 1, 2, 5, 10, 20, 50, 1-5 V.F.S. Temperature <ul style="list-style-type: none"> Thermocouple: K, J, E, T, R, S, B, N, W (We5-26) Resistance Temperature Detector: Pt100, JPt100, Pt1000 (IEC751) Humidity: 0 to 100% R.H. (Voltage 0 to 1 V scaling conversion) * See B-530 (optional) | | | | | | | | | | | | | | | | | | | | | | | | | | | | | | | | | | | | | | | | | | | | | | |
| Measurement accuracy (23 ±5°C) <ul style="list-style-type: none"> 30 minutes or more after power-up Sampling 1 s Filter ON (10) GND connection | Voltage: ±0.1% of F.S. Temperature <ul style="list-style-type: none"> Thermocouple <table border="1"> <thead> <tr> <th>Thermocouple</th> <th>Measurement temperature range (°C)</th> <th>Measurement accuracy</th> </tr> </thead> <tbody> <tr> <td>R/S</td> <td> $0 \leq TS \leq 100$ $100 < TS \leq 300$ R: $300 < TS \leq 1600^{\circ}\text{C}$ S: $300 < TS \leq 1760^{\circ}\text{C}$ </td> <td> $\pm 5.2^{\circ}\text{C}$ $\pm 3.0^{\circ}\text{C}$ $\pm (0.05\% \text{ of rdg} + 2.0^{\circ}\text{C})$ $\pm (0.05\% \text{ of rdg} + 2.0^{\circ}\text{C})$ </td> </tr> <tr> <td>B</td> <td> $400 \leq TS \leq 600$ $600 < TS \leq 1820^{\circ}\text{C}$ </td> <td> $\pm 3.5^{\circ}\text{C}$ $\pm (0.05\% \text{ of rdg} + 2.0^{\circ}\text{C})$ </td> </tr> <tr> <td>K</td> <td> $-200 \leq TS \leq -100$ $-100 < TS \leq 1370^{\circ}\text{C}$ </td> <td> $\pm (0.05\% \text{ of rdg} + 2.0^{\circ}\text{C})$ $\pm (0.05\% \text{ of rdg} + 1.0^{\circ}\text{C})$ </td> </tr> <tr> <td>E</td> <td> $-200 \leq TS \leq -100$ $-100 < TS \leq 800^{\circ}\text{C}$ </td> <td> $\pm (0.05\% \text{ of rdg} + 2.0^{\circ}\text{C})$ $\pm (0.05\% \text{ of rdg} + 1.0^{\circ}\text{C})$ </td> </tr> <tr> <td>T</td> <td> $-200 \leq TS \leq -100$ $-100 < TS \leq 400^{\circ}\text{C}$ </td> <td> $\pm (0.1\% \text{ of rdg} + 1.5^{\circ}\text{C})$ $\pm (0.1\% \text{ of rdgv}0.5^{\circ}\text{C})$ </td> </tr> <tr> <td>J</td> <td> $-200 \leq TS \leq -100$ $-100 < TS \leq 100$ $100 < TS \leq 1100^{\circ}\text{C}$ </td> <td> $\pm 2.7^{\circ}\text{C}$ $\pm 1.7^{\circ}\text{C}$ $\pm (0.05\% \text{ of rdg} + 1.0^{\circ}\text{C})$ </td> </tr> <tr> <td>N</td> <td> $0 \leq TS \leq 1300^{\circ}\text{C}$ $-200 \leq TS < 0^{\circ}\text{C}$ </td> <td> $\pm (0.1\% \text{ of rdg} + 1.0^{\circ}\text{C})$ $\pm (0.1\% \text{ of rdg} + 2.0^{\circ}\text{C})$ </td> </tr> <tr> <td>W</td> <td>$0 \leq TS \leq 2000^{\circ}\text{C}$</td> <td>$\pm (0.1\% \text{ of rdgv}1.5^{\circ}\text{C})$</td> </tr> <tr> <td colspan="2">Reference junction compensation accuracy</td> <td>±0.5°C</td> </tr> </tbody> </table> * Use the thermocouple (T: 0.32φ), otherwise use 0.65φ Resistance Temperature Detector <table border="1"> <thead> <tr> <th>Types</th> <th>Measurement temperature range (°C)</th> <th>Impressed current</th> <th>Measurement accuracy</th> </tr> </thead> <tbody> <tr> <td>Pt100</td> <td>-200 to 850°C (F.S.=1050°C)</td> <td>1 mA</td> <td>±1.0°C</td> </tr> <tr> <td>JPt100</td> <td>-200 to 500°C (F.S.=700°C)</td> <td>1 mA</td> <td>±0.8°C</td> </tr> <tr> <td>Pt1000</td> <td>-200 to 500°C (F.S.=700°C)</td> <td>0.2 mA</td> <td>±0.8°C</td> </tr> </tbody> </table> | Thermocouple | Measurement temperature range (°C) | Measurement accuracy | R/S | $0 \leq TS \leq 100$ $100 < TS \leq 300$ R: $300 < TS \leq 1600^{\circ}\text{C}$ S: $300 < TS \leq 1760^{\circ}\text{C}$ | $\pm 5.2^{\circ}\text{C}$ $\pm 3.0^{\circ}\text{C}$ $\pm (0.05\% \text{ of rdg} + 2.0^{\circ}\text{C})$ $\pm (0.05\% \text{ of rdg} + 2.0^{\circ}\text{C})$ | B | $400 \leq TS \leq 600$ $600 < TS \leq 1820^{\circ}\text{C}$ | $\pm 3.5^{\circ}\text{C}$ $\pm (0.05\% \text{ of rdg} + 2.0^{\circ}\text{C})$ | K | $-200 \leq TS \leq -100$ $-100 < TS \leq 1370^{\circ}\text{C}$ | $\pm (0.05\% \text{ of rdg} + 2.0^{\circ}\text{C})$ $\pm (0.05\% \text{ of rdg} + 1.0^{\circ}\text{C})$ | E | $-200 \leq TS \leq -100$ $-100 < TS \leq 800^{\circ}\text{C}$ | $\pm (0.05\% \text{ of rdg} + 2.0^{\circ}\text{C})$ $\pm (0.05\% \text{ of rdg} + 1.0^{\circ}\text{C})$ | T | $-200 \leq TS \leq -100$ $-100 < TS \leq 400^{\circ}\text{C}$ | $\pm (0.1\% \text{ of rdg} + 1.5^{\circ}\text{C})$ $\pm (0.1\% \text{ of rdgv}0.5^{\circ}\text{C})$ | J | $-200 \leq TS \leq -100$ $-100 < TS \leq 100$ $100 < TS \leq 1100^{\circ}\text{C}$ | $\pm 2.7^{\circ}\text{C}$ $\pm 1.7^{\circ}\text{C}$ $\pm (0.05\% \text{ of rdg} + 1.0^{\circ}\text{C})$ | N | $0 \leq TS \leq 1300^{\circ}\text{C}$ $-200 \leq TS < 0^{\circ}\text{C}$ | $\pm (0.1\% \text{ of rdg} + 1.0^{\circ}\text{C})$ $\pm (0.1\% \text{ of rdg} + 2.0^{\circ}\text{C})$ | W | $0 \leq TS \leq 2000^{\circ}\text{C}$ | $\pm (0.1\% \text{ of rdgv}1.5^{\circ}\text{C})$ | Reference junction compensation accuracy | | ±0.5°C | Types | Measurement temperature range (°C) | Impressed current | Measurement accuracy | Pt100 | -200 to 850°C (F.S.=1050°C) | 1 mA | ±1.0°C | JPt100 | -200 to 500°C (F.S.=700°C) | 1 mA | ±0.8°C | Pt1000 | -200 to 500°C (F.S.=700°C) | 0.2 mA | ±0.8°C |
| Thermocouple | Measurement temperature range (°C) | Measurement accuracy | | | | | | | | | | | | | | | | | | | | | | | | | | | | | | | | | | | | | | | | | | | | | |
| R/S | $0 \leq TS \leq 100$ $100 < TS \leq 300$ R: $300 < TS \leq 1600^{\circ}\text{C}$ S: $300 < TS \leq 1760^{\circ}\text{C}$ | $\pm 5.2^{\circ}\text{C}$ $\pm 3.0^{\circ}\text{C}$ $\pm (0.05\% \text{ of rdg} + 2.0^{\circ}\text{C})$ $\pm (0.05\% \text{ of rdg} + 2.0^{\circ}\text{C})$ | | | | | | | | | | | | | | | | | | | | | | | | | | | | | | | | | | | | | | | | | | | | | |
| B | $400 \leq TS \leq 600$ $600 < TS \leq 1820^{\circ}\text{C}$ | $\pm 3.5^{\circ}\text{C}$ $\pm (0.05\% \text{ of rdg} + 2.0^{\circ}\text{C})$ | | | | | | | | | | | | | | | | | | | | | | | | | | | | | | | | | | | | | | | | | | | | | |
| K | $-200 \leq TS \leq -100$ $-100 < TS \leq 1370^{\circ}\text{C}$ | $\pm (0.05\% \text{ of rdg} + 2.0^{\circ}\text{C})$ $\pm (0.05\% \text{ of rdg} + 1.0^{\circ}\text{C})$ | | | | | | | | | | | | | | | | | | | | | | | | | | | | | | | | | | | | | | | | | | | | | |
| E | $-200 \leq TS \leq -100$ $-100 < TS \leq 800^{\circ}\text{C}$ | $\pm (0.05\% \text{ of rdg} + 2.0^{\circ}\text{C})$ $\pm (0.05\% \text{ of rdg} + 1.0^{\circ}\text{C})$ | | | | | | | | | | | | | | | | | | | | | | | | | | | | | | | | | | | | | | | | | | | | | |
| T | $-200 \leq TS \leq -100$ $-100 < TS \leq 400^{\circ}\text{C}$ | $\pm (0.1\% \text{ of rdg} + 1.5^{\circ}\text{C})$ $\pm (0.1\% \text{ of rdgv}0.5^{\circ}\text{C})$ | | | | | | | | | | | | | | | | | | | | | | | | | | | | | | | | | | | | | | | | | | | | | |
| J | $-200 \leq TS \leq -100$ $-100 < TS \leq 100$ $100 < TS \leq 1100^{\circ}\text{C}$ | $\pm 2.7^{\circ}\text{C}$ $\pm 1.7^{\circ}\text{C}$ $\pm (0.05\% \text{ of rdg} + 1.0^{\circ}\text{C})$ | | | | | | | | | | | | | | | | | | | | | | | | | | | | | | | | | | | | | | | | | | | | | |
| N | $0 \leq TS \leq 1300^{\circ}\text{C}$ $-200 \leq TS < 0^{\circ}\text{C}$ | $\pm (0.1\% \text{ of rdg} + 1.0^{\circ}\text{C})$ $\pm (0.1\% \text{ of rdg} + 2.0^{\circ}\text{C})$ | | | | | | | | | | | | | | | | | | | | | | | | | | | | | | | | | | | | | | | | | | | | | |
| W | $0 \leq TS \leq 2000^{\circ}\text{C}$ | $\pm (0.1\% \text{ of rdgv}1.5^{\circ}\text{C})$ | | | | | | | | | | | | | | | | | | | | | | | | | | | | | | | | | | | | | | | | | | | | | |
| Reference junction compensation accuracy | | ±0.5°C | | | | | | | | | | | | | | | | | | | | | | | | | | | | | | | | | | | | | | | | | | | | | |
| Types | Measurement temperature range (°C) | Impressed current | Measurement accuracy | | | | | | | | | | | | | | | | | | | | | | | | | | | | | | | | | | | | | | | | | | | | |
| Pt100 | -200 to 850°C (F.S.=1050°C) | 1 mA | ±1.0°C | | | | | | | | | | | | | | | | | | | | | | | | | | | | | | | | | | | | | | | | | | | | |
| JPt100 | -200 to 500°C (F.S.=700°C) | 1 mA | ±0.8°C | | | | | | | | | | | | | | | | | | | | | | | | | | | | | | | | | | | | | | | | | | | | |
| Pt1000 | -200 to 500°C (F.S.=700°C) | 0.2 mA | ±0.8°C | | | | | | | | | | | | | | | | | | | | | | | | | | | | | | | | | | | | | | | | | | | | |
| Reference junction compensation | Internal/External switching | | | | | | | | | | | | | | | | | | | | | | | | | | | | | | | | | | | | | | | | | | | | | | |
| A/D converter | System : ΔΣsystem Resolution : 16-bit (Effective ability: approximate ± range 1/40,000) | | | | | | | | | | | | | | | | | | | | | | | | | | | | | | | | | | | | | | | | | | | | | | |
| Temperature coefficient | Gain: 0.01% of F.S./°C Zero: 0.02% of F.S./°C * Zero is generated when using the sampling 10, 20, or 50 ms. | | | | | | | | | | | | | | | | | | | | | | | | | | | | | | | | | | | | | | | | | | | | | | |
| Input resistance | 1 MΩ±5% | | | | | | | | | | | | | | | | | | | | | | | | | | | | | | | | | | | | | | | | | | | | | | |
| Input signal source resistance | 300 Ω or less | | | | | | | | | | | | | | | | | | | | | | | | | | | | | | | | | | | | | | | | | | | | | | |
| Maximum input voltage | Input terminal +/- interval: 60 Vp-p Input terminal (-)/Input terminal (-) interval: 60 Vp-p Input terminal (-)/GND terminal interval: 60 Vp-p * For details, see "(2) Voltage/Temperature module" in page 2-31. | | | | | | | | | | | | | | | | | | | | | | | | | | | | | | | | | | | | | | | | | | | | | | |
| Withstand voltage | Input terminal (-)/Input terminal (-) interval: 350 Vp-p for 1 minute Input terminal (-)/GND terminal interval: 350 Vp-p for 1 minute * For details, see "(2) Voltage/Temperature module" in page 2-31. | | | | | | | | | | | | | | | | | | | | | | | | | | | | | | | | | | | | | | | | | | | | | | |

Logic/Pulse Amplifier Module (Logic/Pulse) (GL7-L/P: optional)

| Item | Description |
|---|---|
| Number of input channels | 16 channels/1 module |
| Input terminal shape | Dedicated connector (1 group per 4-ch) |
| Input method | Non-isolated, All-ch insulation, simultaneous sampling, unbalanced input |
| Sampling interval | Logic: 1 μ sec fastest Pulse: 100 μ sec fastest |
| Built-in RAM | 2,000,000 data |
| Functions | Logic/Pulse * Switching logic/pulse for each unit The maximum use of the Logic function is 7 modules (112ch). The maximum use of the Pulse function is 2 modules (32ch). The maximum number of connections for each type of amplifier module to the GL7000 is up to 10 modules (112ch maximum). |
| Mode | Pulse : Rotation/Accumulating/Instant |
| Revolve mode | Function : This mode counts the pulses for every sampling interval, and then converts them to the RPM. Span : 50, 500, 5000, 50 k, 500 k, 5 M, 50 M, 500 M .RPM/F.S. |
| Counts mode | Function : Mode for displaying the number of pulses accumulated for every sample interval from the beginning of the recording. Span : 50, 500, 5000, 50 k, 500 k, 5 M, 50 M, 500 M C/F.S. |
| Instant mode | Function: Mode for displaying the pulse count for every sampling interval. The pulse count is reset for every sampling interval. Span : 50, 500, 5000, 50 k, 500 k, 5 M, 50 M, 500 M C/F.S. |
| Maximum input frequency | 1 MHz |
| Maximum number of counts | 15 MC (24-bit counter) |
| Input specifications | Max. input voltage : 0 to +24 V (single-ended ground input) Input signal : Non-voltage contact (a contact, b contact, NO, NC), Open collector, Voltage input Input threshold voltage : approx. +2.5 V Hysteresis : approx. 0.5 V (approx. +2.5 V to +3 V) |
| Filter | OFF, ON (50 Hz, approx. -3 dB) |
| External dimensions (approx.) [W x D x H] | 49.2 x 136 x 160 mm (Not including protruding parts) |
| Weight (approx.) | 700 g |







High-voltage Module (For high-voltage measurements) (GL7-HV: optional)

| Item | Description |
|---|---|
| Number of input channels | 2ch/1 module |
| Input terminal shape | Insulated BNC cable |
| Input method | All-ch insulation, simultaneous sampling, unbalanced input |
| Sampling interval | 1 μ sec fastest |
| Built-in RAM | 2,000,000 data |
| Input coupling | DC, AC, DC-RMS, AC-RMS |
| Measurement range | DC/AC: 2, 5, 10, 20, 50, 100, 200, 500, 1000 V F.S. DC-RMS, AC-RMS: 1, 2, 5, 10, 20, 50, 100, 200, 500Vrms F.S. Crest Factor: (Range between 1 and 200Vrms) 4 or less (Range of 500 Vrms) 2 or less |
| Measurement accuracy (23 \pm 5 $^{\circ}$ C) • 30 minutes or more after power-up • Filter Line (DC) • GND connection | DC/AC: \pm 0.25% of F.S. DC-RMS: Sine wave \pm 0.5% of F.S. (20 Hz \leq F \leq 1 kHz) \pm 1.5% of F.S. (1 kHz < F \leq 20 kHz) AC-RMS: Sine wave \pm 0.5% of F.S. (100 Hz \leq F \leq 1 kHz) \pm 1.5% of F.S. (1 kHz < F \leq 20 kHz) Response time: 500ms or less (Crest Factor 4 or less) * For information about the crest factor, refer to the next page. |
| A/D converter | System: sequential comparison system Resolution: 16-bit Effective Resolution (DC, AC) : Approx. \pm Range 1/40,000 (DC-RMS, AC-RMS) : Approx. Range 1/20,000 |
| Temperature coefficient | Gain: 0.01% of F.S./ $^{\circ}$ C Zero: 0.02% of F.S./ $^{\circ}$ C |
| Input resistance | 1 M Ω \pm 5% |
| Input signal source Resistance | 1 k Ω or less |
| Maximum input voltage | Input terminal (+)/Input terminal (-) interval: 1000 Vp-p Input terminal (-)/Input terminal (-) interval: 300 VACrms Input terminal (-)/GND terminal interval: 300 VACrms * For details, see "(5) High Voltage module" in page 2-36. |
| Withstand voltage | Input terminal (-)/Input terminal (-) interval: 2300 VACrmsfor 1 minute Input terminal (-)/GND terminal interval: 2300 VACrmsfor 1 minute * For details, see "(5) High Voltage module" in page 2-36. |
| Insulation resistance | Input terminal (-)/GND terminal interval: 50 M Ω or more (at 500 VDC) |
| Common mode rejection | 90 dB or more (50/60 Hz signal source 300 Ω or less) |
| S/N (Noise) | 48 dB or more (+/- at short) |
| Frequency response | DC Coupling: DC to 200 kHz (+1/-3 dB) AC Coupling: 4 Hz to 200 kHz (+1/-4.5 dB) |
| Filter | L.P.F.: OFF, Line (1.5Hz), 5Hz, 50Hz, 500Hz, 5kHz, 50kHz Attenuation: -3 dB (-5.2 dB to -1.4 dB)/6 dB oct |
| External dimensions (approx.) [W x D x H] | 49.2 x 136 x 160 mm (Not including protruding parts) |
| Weight (approx.) | 740 g |

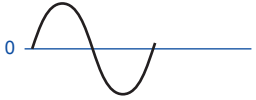
Overview of crest factor

Crest factor is represented by the ratio of the peak value to the effective value of each range. This parameter is necessary to measure the effective value.

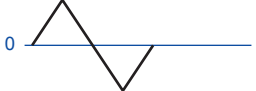
$$\text{Crest factor} = \frac{\text{Peak value}}{\text{Effective value}}$$

| Waveform | | Effective value of input waveform | True effective value (displayed value) | Crest Factor |
|--|---|-----------------------------------|--|----------------------|
| Sine wave Sine curve |  | 1 | 1 | 1.414 |
| Full-wave rectification Sine wave Sine curve |  | 1 | 0.435 | 1.414 |
| Half-wave rectification Sine wave Sine curve |  | 1 | 0.771 | 2 |
| Square wave |  | 1 | 1 | 1 |
| Triangular wave |  | 1 | 0.707 | 1.732 |
| Pulse wave (duty = 50%) |  | 1 | 0.707 | 1.414 |
| Pulse wave |  | 1 | $\sqrt{1 - \frac{S}{T}}$ | $\sqrt{\frac{T}{S}}$ |

DC Strain Module (For Strain/voltage/resistance measurement)(GL7-DCB: optional)

| Item | Description |
|---|--|
| Input ch number | 4 ch/1 module |
| Input terminal shape | DSUB 9-pin (female) |
| Input method | All ch insulation, simultaneous sampling, balanced input |
| Sampling interval | 10 μ s to 1 hour |
| Built-in RAM | 2,000,000 data |
| Input type | Strain, voltage, resistance values (including potentiometer) |
| Measurement range | Strain gauge/Strain sensor: 400, 500, 800, 1000, 2000, 4000, 5000, 8000, 10000, 20000 $\mu\epsilon$ ($\mu\epsilon$: 10^{-6} Strain) 0.2, 0.25, 0.4, 0.5, 1, 2, 2.5, 4, 5, 10 mV/V * The range depends on the bridge voltage. Voltage: 1, 2, 5, 10, 20, 50, 100, 200, 500 mV, 1, 2, 5 V Resistance: 1, 2, 5, 10, 20, 50, 100, 200, 500 Ω , 1, 2, 5, 10, 20, 50 k Ω |
| Measurement accuracy *1 (23°C \pm 5°C) | Strain: \pm (0.2% of F.S. +10 $\mu\epsilon$) Voltage: \pm (0.2% of F.S. +10 μ V) Resistance: \pm 0.5% of F.S. *1: After power-on, more than 30 minutes, sampling 1 sec., filter line, GND |
| A/D converter | System: sequential comparison system Resolution: 16-bit (Effective Resolution: Approx. \pm Range 1/40,000) |
| Gauge factor | 2.0 constant |
| Sensor supported | Strain: [Strain gauge transducer] 4-wire full bridge, 6-wire full bridge (Available for remote sensing) [Strain gauge] 4-wire full bridge, 6-wire full bridge (3/4-wire: available for remote sensing) 3 or 4 or 5-wire 1/2bridge (4/5-wire: available for remote sensing) 4 or 6-wire full bridge (6-wire: available for remote sensing) Resistance: Potentiometer, resistance |
| Internal gauge resistance | 50 to 10 k Ω (Bridge voltage 1 V: 50 Ω to 10 k Ω , 2 V: 100 Ω to 10 k Ω , 2.5 V: 120 Ω to 10 k Ω , 5 V/10V: 350 Ω to 10 k Ω) |
| Internal gauge resistor | 1/4bridge or 1/2bridge: (available for 120 Ω and 350 Ω gauges) * When the internal gauge resistance is 120 Ω , the bridge voltage 1, 2, 2.5 V are available. |
| Bridge voltage | DC 1, 2, 2.5, 5, 10 V * When the bridge voltage is 5 V or more, 350 Ω or more gauge is available. |
| Constant current bridge power supply | 0.1 to 20 mA (Voltage supported: Max.10V) |
| Balancing | Method: Auto-balancing (Range: \pm 10,000 $\mu\epsilon$)*Strain input only |
| Remote Sensing | 3 or 4-wire 1/4bridge, 4 or 5-wire 1/2 bridge, and 6-wire full bridge are available. |
| Shunt calibration | Internal approximate 60 k Ω (120 Ω gauge), approximate 175 k Ω (350 Ω gauge) |
| Temperature coefficient | Gain: \pm 0.02% of F.S./ $^{\circ}$ C 0 point: \pm 1.2 $\mu\epsilon$ / $^{\circ}$ C |
| Input resistance | 10 M Ω \pm 5% |
| Maximum input voltage | Differential input: DC10 V Common-mode voltage: 10 VACrms Input terminal(-) /Input terminal (-) interval : 10 Vp-p Input terminal (-)/GND terminal interval : 60Vp-p * For details, see "(6) DC Strain Module" in page 2-37. |
| Withstand voltage | Input terminal (-)/GND terminal interval : 1000Vp-p 1 minute * For details, see "(6) DC Strain Module" in page 2-37. |
| Insulation resistance | Input terminal (-)/GND terminal interval: 100 M Ω or more (at DC500 V) |
| Common mode rejection ratio | 80 dB or more (50/60 Hz signal source 300 Ω or less) |
| Noise | 50 $\mu\epsilon$ or less (DC2V, 350 Ω) |
| Frequency response | DC to 20 kHz |
| Filter | L.P.F.: OFF, Line (1.5 Hz) 3, 6, 10, 30, 50, 60,100, 300, 500 Hz, 1, 3, 5, 10kHz at -30 dB/oct A.A.F.: OFF/ON (Anti-aliasing filter) |
| TEDS | Standards: Conforms to IEEE1451.4 Class2 (Template No. 33) Information: Readout and auto-set for sensor data |
| Accessorie | DSUB (male) connector : 4 |
| External dimensions (approx.) [W x D x H] | 49.2 x 136 x 160 mm (not including protruding parts) |
| Weight (approximate) | 840 g |

Charge Module (For Acceleration measurement)(GL7-CHA: optional)

| Item | Description |
|--|--|
| Input ch number | 4 ch/1 module |
| Input terminal shape | BNC terminal (non-isolated) Miniature connector (#10-32UNF) * Only one terminal is available for each channel. |
| Input method | Insulation, simultaneous sampling, unbalanced input |
| Sampling interval | 10 μ s to 1 hour |
| Built-in RAM | 2,000,000 data |
| Input coupling | Off, Charge, IEPE, DC, AC, Charge-RMS, IEPE-RMS, DC -RMS, AC-RMS |
| Measurement range | Acceleration sensor: 1, 2, 10, 20, 50, 100, 200, 500 m/s^2 1000, 2000, 5000, 10000, 20000, 50000 m/s^2 Voltage input: AC, DC : 50, 100, 200, 500 mV, 1, 2, 5, 10 V RMS: 20, 50, 100, 200, 500 mVrms, 1, 2, 5 Vrms Crest Factor: (2 Vrms range or less) 4 or less, (5 Vrms range) 2 or less |
| Sensor sensitivity | Charge input: 0.01 pC/(m/s^2) to 999.9 pC/(m/s^2) Voltage input: 0.01 mV/(m/s^2) to 999.9 mV/(m/s^2) |
| Measurement accuracy *1 (23°C \pm 5°C) | Charge input: \pm 0.9% of F.S. [Sensor sensitivity] x [Setting range] \geq 20 pC Voltage input: \pm 0.25% of F.S. [Sensor sensitivity] x [Setting range] \geq 200 mV *1: After power-on, more than 30 minutes, sampling 1 sec., filter line, GND |
| A/D converter | System: sequential comparison system Resolution: 16-bit (Effective Resolution: Approx. \pm Range 1/40,000) |
| Temperature coefficient | Gain: \pm 0.01% of F.S./°C Zero: \pm 0.02% of F.S./°C |
| Input resistance | 100 k Ω \pm 5% |
| Power supply | 22 V \pm 10%, 4 mA, 8 mA \pm 20% |
| Max. input charge | 50,000 pC |
| Maximum input voltage | Input terminal(+) / Input terminal (-) interval: 25 Vp-p Input terminal(-) / Input terminal (-) interval: 25 Vp-p Input terminal (-)/GND terminal interval: 25 Vp-p * For details, see "(7) Charge Module" in page 2-42. |
| Withstand voltage | Input terminal(+) / Input terminal (-) interval : 300 Vp-p 1 minute Input terminal (-)/GND terminal interval: 300 Vp-p 1 minute * For details, see "(7) Charge Module" in page 2-42. |
| Insulation resistance | Input terminal (-)/GND terminal interval: 50 M Ω or more (at DC500 V) |
| Common mode rejection ratio | 80 dB or more (50/60 Hz signal source 300 Ω or less) |
| S/N (Noise) | 48 db or more (+/- at short) |
| Frequency response | Charge-type: 1.5 Hz to 45 kHz Voltage-type: 1 Hz to 45 kHz |
| Filter | H.P.F.: OFF, 0.15, 1, 10 Hz L.P.F.: OFF, Line (1.5 Hz) 3, 6, 10, 30, 50, 60 Hz, 100, 300, 500 Hz, 1, 3, 5, 10 kHz at -30 dB/oct A.A.F.: OFF, ON (Anti-aliasing filter) |
| TEDS | Standards: Conforms to IEEE1451.4 Class1 (Template No. 25) Information: Readout and auto-set for sensor data |
| External dimensions (approx.) [W x D x H] | 49.2 x 136 x 160 mm (not including protruding parts) |
| Weight (approximate) | 850g |

Voltage Output Module (For output voltage measurement) (GL7-DCO: optional)

| Item | Description |
|--|---|
| Output ch number | 8 ch/1 module |
| Output terminal shape | SMA connector |
| Output method | All channels common ground |
| Sampling interval | 10 fastest |
| Output objects | Off, Data file (Recorded data in the module to be output, Simple arbitrary waveform Note 1) DC, Sine wave, Traiangle wave, Ramp wave, Pulse wave <Equipment to be output> Recorded data module that can output the voltage <ul style="list-style-type: none"> • Voltage module (GL7-V) • Voltage/Temperature module (GL7-M) • High speed voltage module (GL7-HSV) • High voltage module (GL7-HV) • DC Strain module (GL7-DCB) • Charge module (GL7-CHA) < Output Conditions > <ul style="list-style-type: none"> • The sample interval is 10 s or more • While the waveform is output from the output module, the data measured in the other amplifier module can be recorded.Data type • Not possible to output the data of Temperature / Humidity and Logic / Pulse Note 1: Using the GL-Wave Editor supplied with the GL-Connection, the CSV waveform data can be generated arbitrarily. * Microsoft EXCEL (Office 2003 or later) must be installed." |
| Output range | ±1, 2, 5, 10 V/F.S. |
| Output accuracy (23°C ±5°C) | ±0.25% of F.S. * At least 30 minutes after turning on the power. |
| D/A converter | Resolution: 16-bit (Effective ability: Approximate ± range 1/20,000) |
| Temperature coefficient | Gain: ±0.01% of F.S./°C Zero: ±0.02% of F.S./°C" |
| Allowable load resistance | 1kΩ or more |
| Maximum output current | Maximum output current ±10 mA/ch However, total ±40 mA or less of the output current per 1 module should be used. |
| Output impedance | 1Ω or less |
| S/N (Noise) | 48 dB or more (at OV output) |
| Filter | L. P. F : OFF, Line (1.5 Hz), 5 Hz, 50 Hz, 500 Hz, 5 kHz, 50 kHz *This filter is a smoothing filter to remove noise of the D/A converter. |
| External dimensions (approx.) [W × D × H] | 49.2 × 136 × 160 mm (not including protruding parts) |
| Weight (approximate) | 770g |

4.5 Accessory/Option Specifications

Control software (GL-Connection)

| Item | Description |
|--|--|
| OS supported | Windows 8 (32/64-Bit) / Windows 7 (32/64-Bit) (StarterEdition not available) / Vista (32/64-Bit) / XP (SP2 or higher) |
| Functions | Controlling main module, real-time recording data, conversion, data replay |
| Number of main module connected | Max. 10 modules* ¹ |
| Number of channels per one main module | Max. 112 channels* ¹ |
| Max. number of channels | 1120 channels* ¹ |
| Setting range | Amplifier settings, recording settings, trigger/alarm settings, report settings, others |
| Captured data | Built-in RAM (binary) SSD (CSV, binary) Built-in flash memory (CSV, binary) SD card (CSV, binary) * For CSV data, the corresponding high speed sampling interval will be up to 1 msec. (For 1CH) * The recorded data cannot save the built-in RAM or SSD in real time. After recorded, the data is saved in PC while replaying on the GL7000. |
| Display | Analog waveforms, logic waveforms, pulse waveforms, digital values |
| Display modes | Y-T View (displayed in the digital value), X-Y View (in real time), FFT View, Cursor Information View, Recorded Data View, Alarm Information View * Digital display can be attained by maximizing the digital part of the Y-T. |
| File conversion | Between cursors, All data, Thinning function |
| Mailing functionality | A mail is sent to a specified address when an alarm occurs |
| Statistics display | During recording: maximum value, minimum value, Average value, peak value During replaying: maximum value, minimum value, Average value, peak value, RMS |
| Search function | Level search : Searches at any channel or any level. Alarm search: Searches at any channel or any alarm. Time move : Move to first, Move to last, Move to center, Move to trigger, Move to absolute time, Move to Relative time, Move to data points, Move to mark. |
| Screen lock function | Locks the operation (with arbitrary password setting function) |
| Data output function | PC file data (GBD/CSV), Module file data (GBD), DC, Sinusoidal wave, Triangular wave, Ramp wave, Pulse wave * GL-Connection version 1.40 or later * When the Voltage Output Module is installed, this function is available |

*1: There are limitations to real-time transfer. The more the number of channels increases, the more limited the real-time display of the sampling interval becomes.

The number of DC strain modules that can be installed is up to 8 modules.

Standard accessories

| Item | Description | Quantity |
|---------------------|---|----------|
| Alarm Output Module | This is installed in the main module at shipping. | 1 |
| Quick Start Guide | GL7000-UM-85X | 1 |
| CD-ROM | User's Manual (PDF), Application software | 1 |
| Face cover | This is installed in the main module at shipping. | 1 |
| AC cable | | 1 |

Humidity sensor: B-530 (optional)

| Item | Description | | | | | | | | | | | | | | | | | | |
|---|--|-------------------------|----------------------|-----------|---------|------------|---------|------------|---------|------------|---------|------------|---------|------------|---------|------------|---------|------------|---------|
| Allowable temperature range | -25 to +80°C | | | | | | | | | | | | | | | | | | |
| Allowable temperature range | 0 to 100% R.H. | | | | | | | | | | | | | | | | | | |
| System | Electric capacity type | | | | | | | | | | | | | | | | | | |
| Relative humidity measurement accuracy (5 to 98% R.H.) | <table border="1"> <thead> <tr> <th>Measurement environment</th> <th>Measurement accuracy</th> </tr> </thead> <tbody> <tr> <td>0 to 10°C</td> <td>±5%R.H.</td> </tr> <tr> <td>10 to 20°C</td> <td>±4%R.H.</td> </tr> <tr> <td>20 to 30°C</td> <td>±3%R.H.</td> </tr> <tr> <td>30 to 40°C</td> <td>±4%R.H.</td> </tr> <tr> <td>40 to 50°C</td> <td>±5%R.H.</td> </tr> <tr> <td>50 to 60°C</td> <td>±6%R.H.</td> </tr> <tr> <td>60 to 70°C</td> <td>±7%R.H.</td> </tr> <tr> <td>70 to 80°C</td> <td>±8%R.H.</td> </tr> </tbody> </table> | Measurement environment | Measurement accuracy | 0 to 10°C | ±5%R.H. | 10 to 20°C | ±4%R.H. | 20 to 30°C | ±3%R.H. | 30 to 40°C | ±4%R.H. | 40 to 50°C | ±5%R.H. | 50 to 60°C | ±6%R.H. | 60 to 70°C | ±7%R.H. | 70 to 80°C | ±8%R.H. |
| | Measurement environment | Measurement accuracy | | | | | | | | | | | | | | | | | |
| | 0 to 10°C | ±5%R.H. | | | | | | | | | | | | | | | | | |
| | 10 to 20°C | ±4%R.H. | | | | | | | | | | | | | | | | | |
| | 20 to 30°C | ±3%R.H. | | | | | | | | | | | | | | | | | |
| | 30 to 40°C | ±4%R.H. | | | | | | | | | | | | | | | | | |
| | 40 to 50°C | ±5%R.H. | | | | | | | | | | | | | | | | | |
| | 50 to 60°C | ±6%R.H. | | | | | | | | | | | | | | | | | |
| | 60 to 70°C | ±7%R.H. | | | | | | | | | | | | | | | | | |
| 70 to 80°C | ±8%R.H. | | | | | | | | | | | | | | | | | | |
| Response time | 15 sec. (90% response when membrane filter installed) | | | | | | | | | | | | | | | | | | |
| Sensor output | 0 to 1 V DC | | | | | | | | | | | | | | | | | | |
| Outside diameter | φ14 mm×80 mm (excluding cable) | | | | | | | | | | | | | | | | | | |
| Cable Length | 3 m | | | | | | | | | | | | | | | | | | |
| Sensor power | +5 to 16 VDC | | | | | | | | | | | | | | | | | | |
| Consumption current | Approx. 4 mA | | | | | | | | | | | | | | | | | | |

4.6 Accessories

Optional Accessories

| Item | Model | Description |
|--|----------------|--|
| Sync cable for GL7000 | B-559 | Sync cable between devices |
| Probe for logic/pulse | RIC-10 | 4ch input (Set of alligator clip and IC clip) |
| BNC-BNC cable | RIC-112 | 1.5 m, 60VDC or less |
| BNC-Banana cable | RIC-113 | 1.5 m, 60VDC or less |
| BNC-Alligator cable | RIC-114 | 1.5 m, 60VDC or less |
| Safe probe | RIC-141A | 1:1 42pF, Length 1.2 m, 300VDC, CAT II |
| Insulated BNC-BNC cable | RIC-142 | Length 1.5 m, 1000 VDC, CAT II |
| Insulated BNC-Banana cable | RIC-143 | Length 1.6 m, 600 VDC, CAT II |
| Alligator clip (small) *2 | RIC-144A | Aperture: 11 mm, 300 VDC, CAT II, MAX15A |
| Alligator clip (Middle) *2 | RIC-145 | 20 mm, 1000 VDC, CAT III, MAX32A |
| Grabber Clips*2 | RIC-146 | Aperture: 5 mm, 1000 VDC, CAT III, MAX1A |
| Input/output cable for GL | B-513 | 2 m, Bare tips |
| Humidity sensor*1 | B-530 | 3 m, With a dedicated power connector |
| Humidity sensor power box | B-542 | Humidity sensor, 10-wiring, Built to order |
| M3 screws with flat washers | B-543 | 60 pcs. |
| Shunt resistance 250Ω | B-551 | 250Ω, Rated power of 1W, Maximum service voltage of 15.8 V, Built to order |
| DSUB-Screw terminals conversion connector | B-560 | DSUB connecting conversion connector for DC Strain Module |
| DSUB-NDIS conversion cable | B-561 | DSUB-NDIS conversion cable for DC Strain Module only |
| SMA-BNC conversion cable | B-562 | SMA-BNC conversion cable (2 m) for Voltage Output Module |
| Extra fine K-type thermocouple (TC200/TD1000), 5 per set | ST-55K-TC-1.2M | Tip wire \varnothing 0.127, 0.5 x 0.7 x 200 mm, Relay section 1 m, 5 per set |
| Needle-shape K-type thermocouple | RIC-410 | -100 to 300°C, Class 1, Cord length: 1.1 m |
| Stationery-surface K-type thermocouple | RIC-420 | -30 to 400°C, Class 2, Cord length: 1.1 m |
| L-type stationery-surface K-type thermocouple | RIC-430 | -30 to 600°C, Class 2, Cord length: 1.1 m |

*1: Allowable temperature range: -25 to +80°C

*2: One each for red and black, Connect to RIC-143

4.7 External view

GL7000 Main Module + Alarm Module

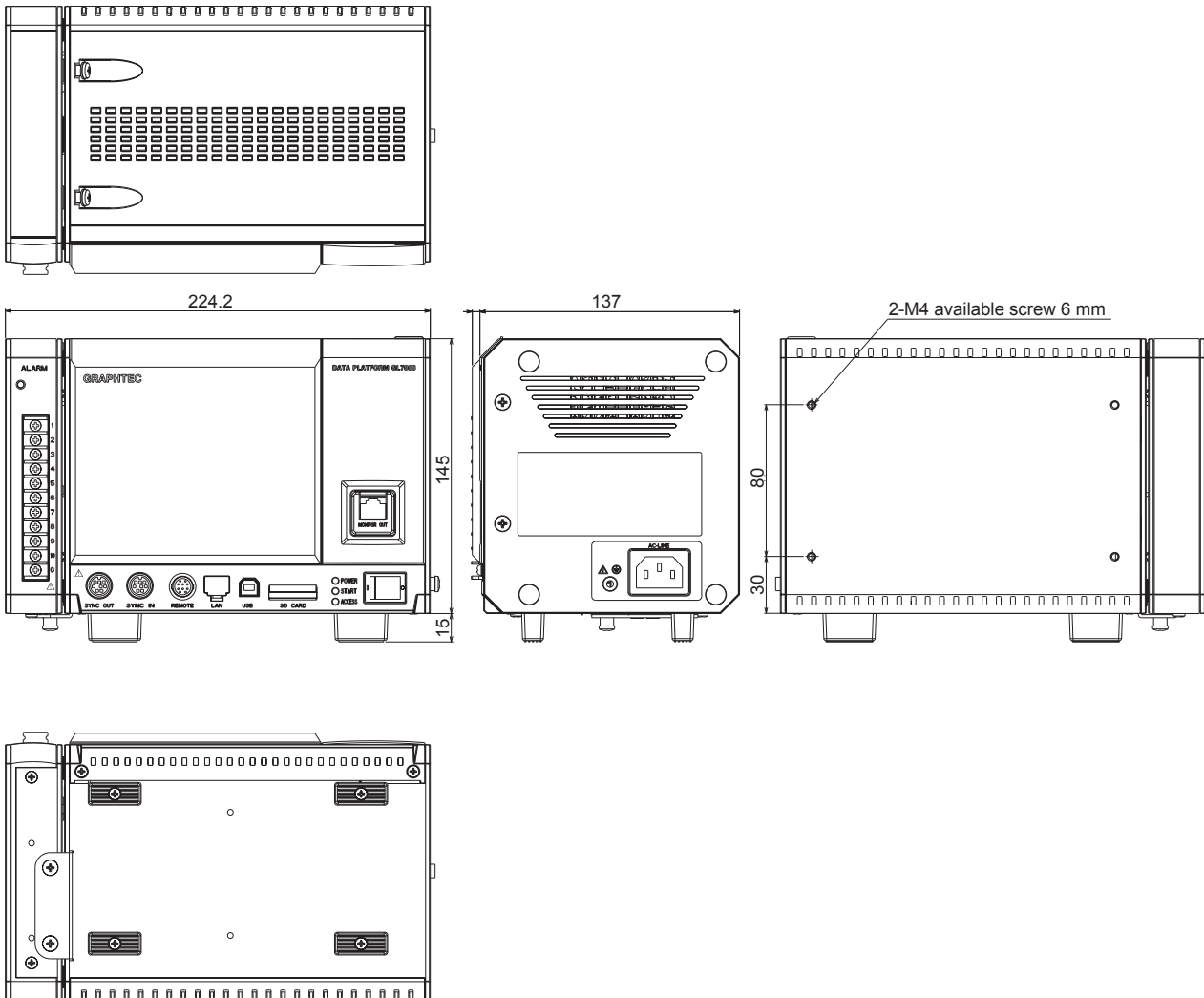

Unit: mm
Dimensional accuracy: ± 5 mm

Display Module (GL7-DISP) : Optional

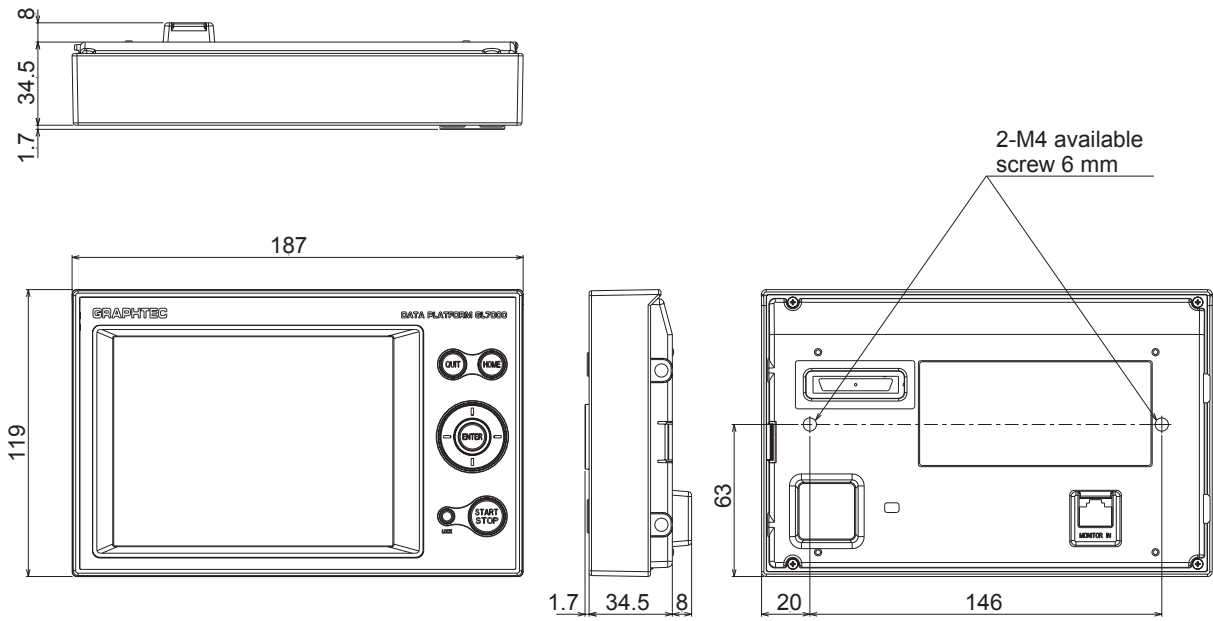

Unit: mm
Dimensional accuracy: ± 5 mm

SSD Module: (GL7-SSD) : Optional

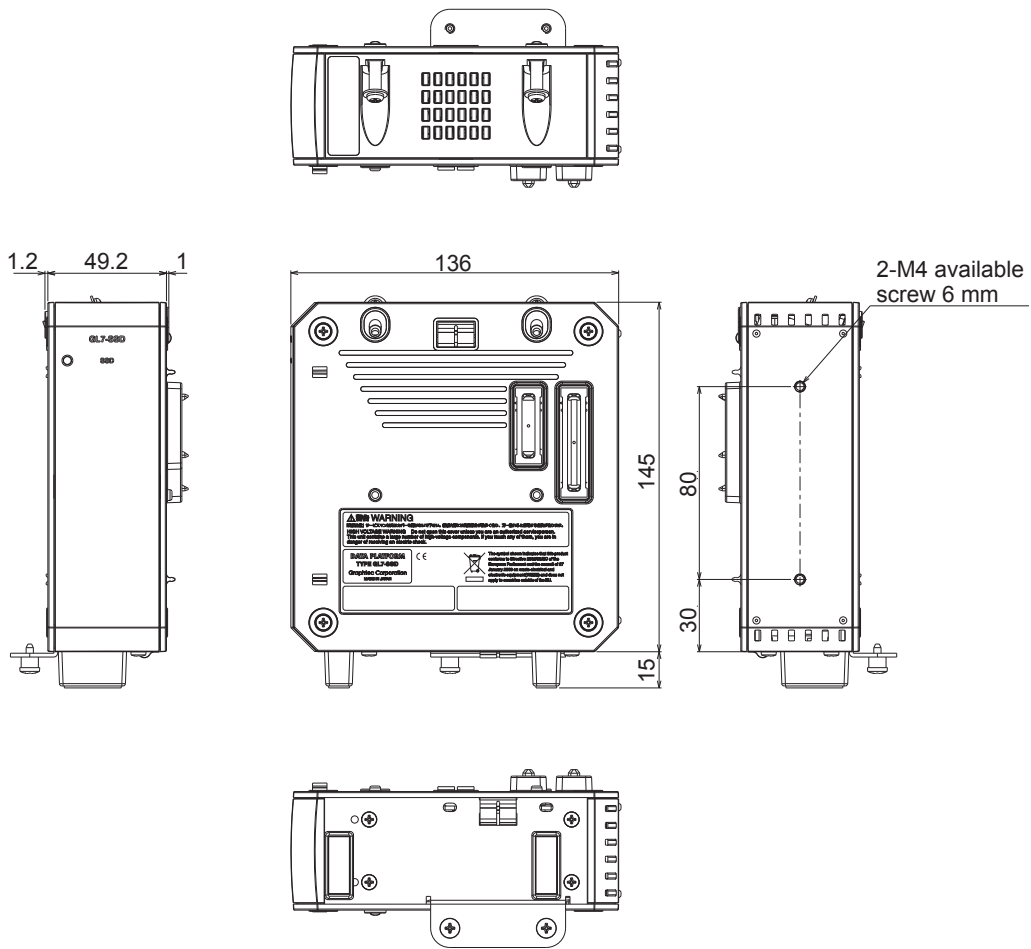

Unit: mm
 Dimensional accuracy: ±5 mm

Voltage Module: (GL7-V) : Optional

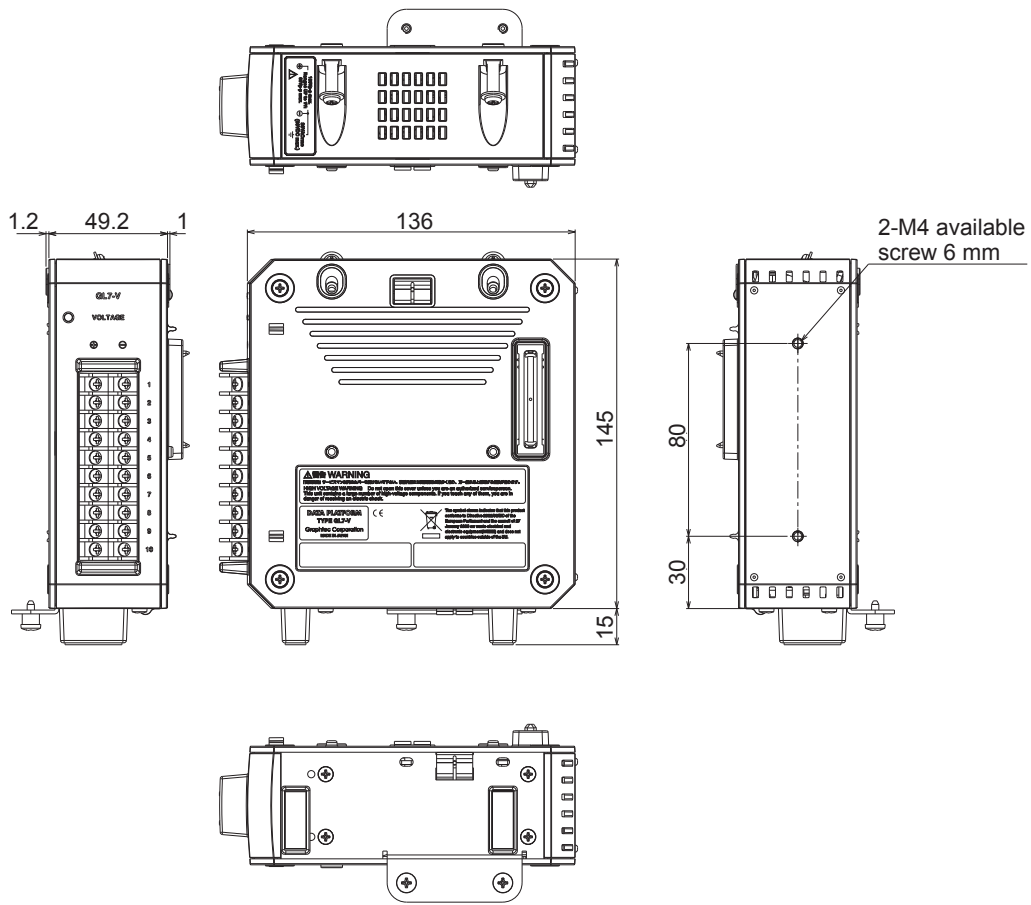

Unit: mm
Dimensional accuracy: ±5 mm

High Speed Voltage Module: (GL7-HSV) : Optional

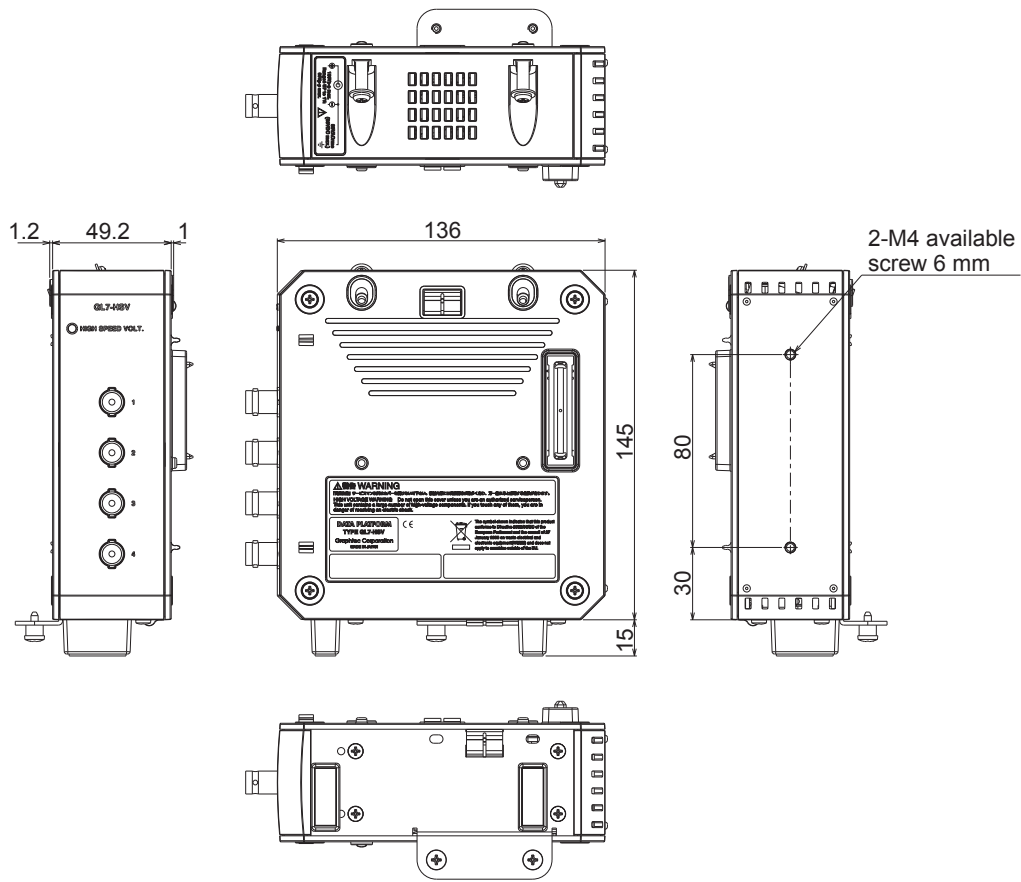

Unit: mm
 Dimensional accuracy: ±5 mm

Voltage/Temperature Module: (GL7-M) : Optional

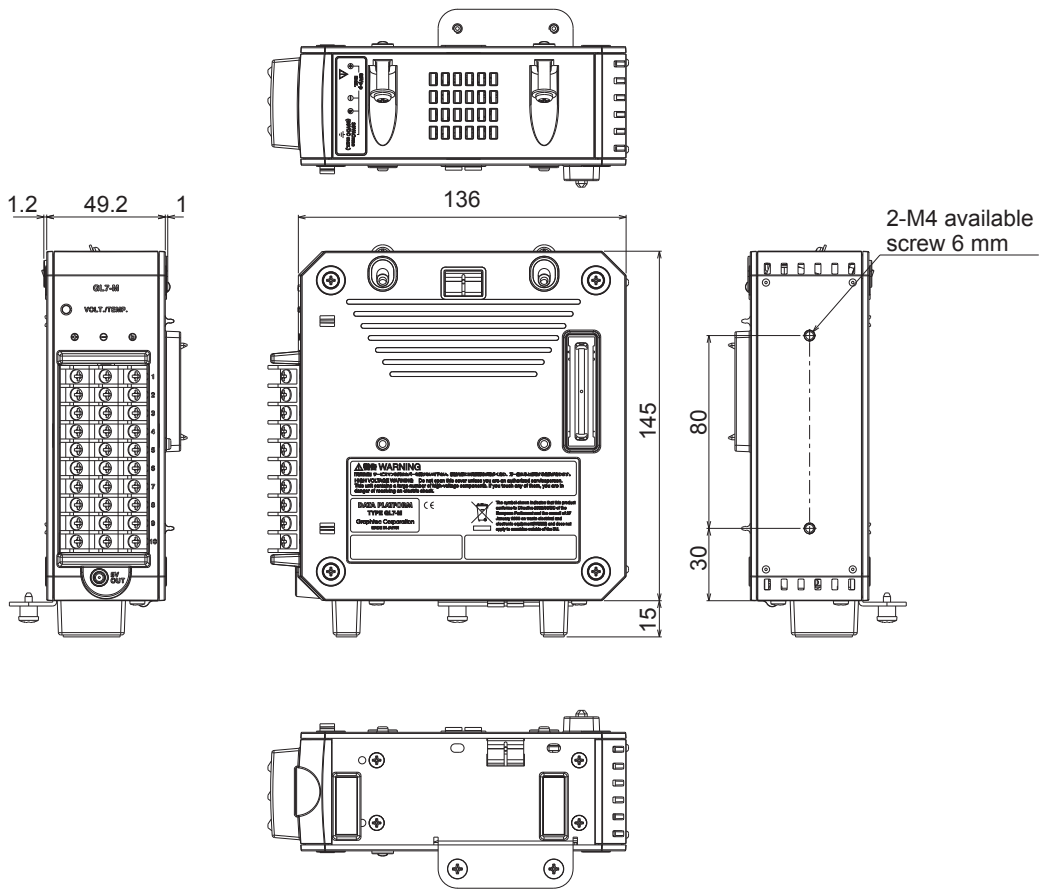

Unit: mm
Dimensional accuracy: ±5 mm

Logic/Pulse Module: (GL7-L/P) : Optional

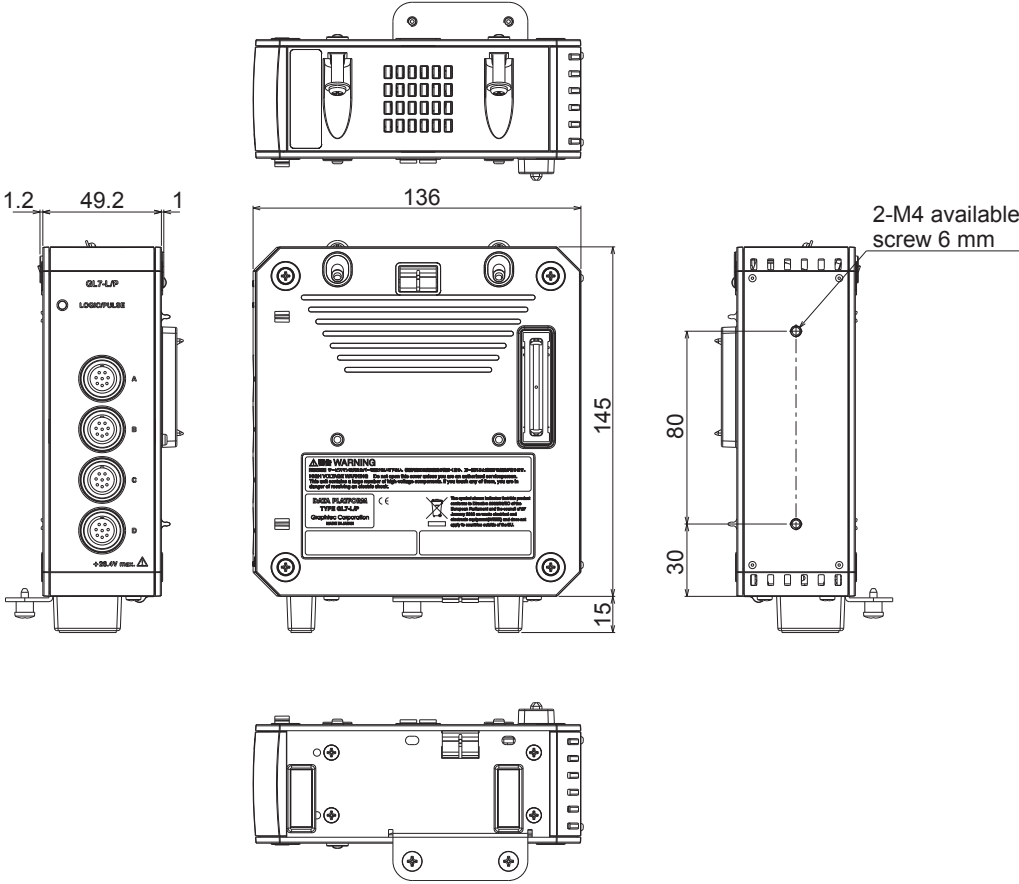

Unit: mm
Dimensional accuracy: ±5 mm

High-voltage Module: (GL7-HV) : Optional

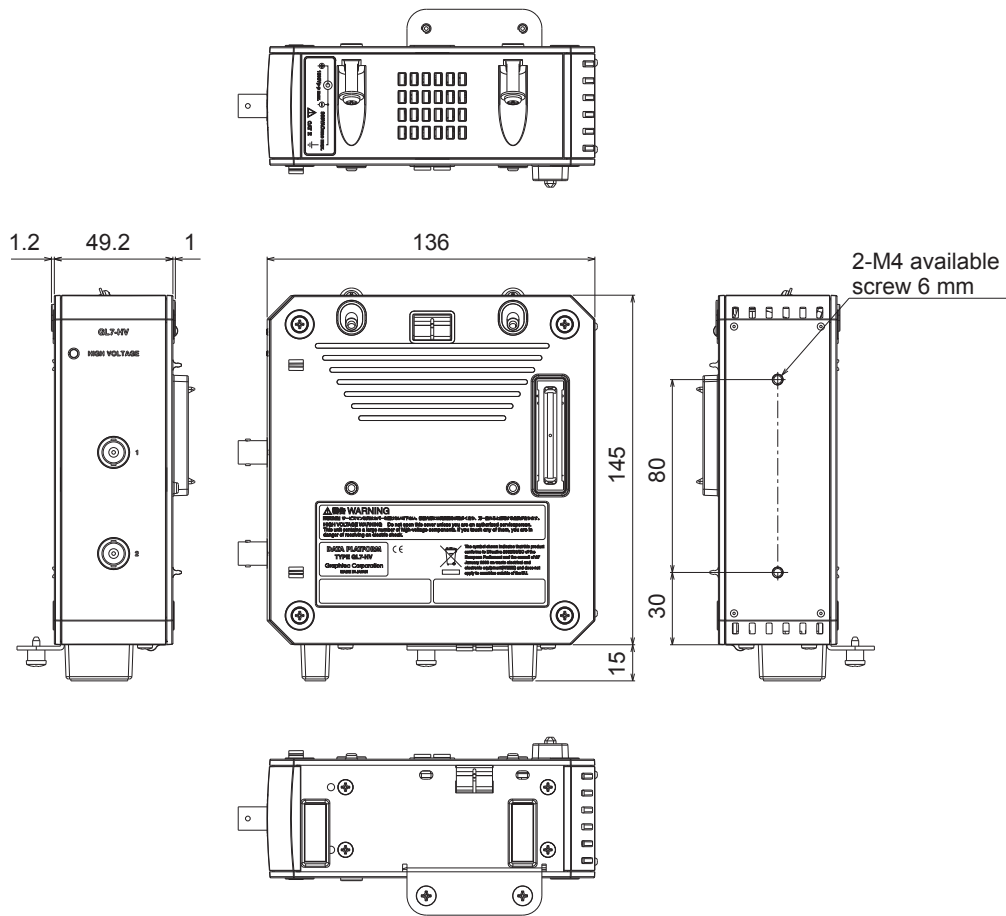

Unit: mm
Dimensional accuracy: ± 5 mm

Charge Module (GL7-CHA): Optional

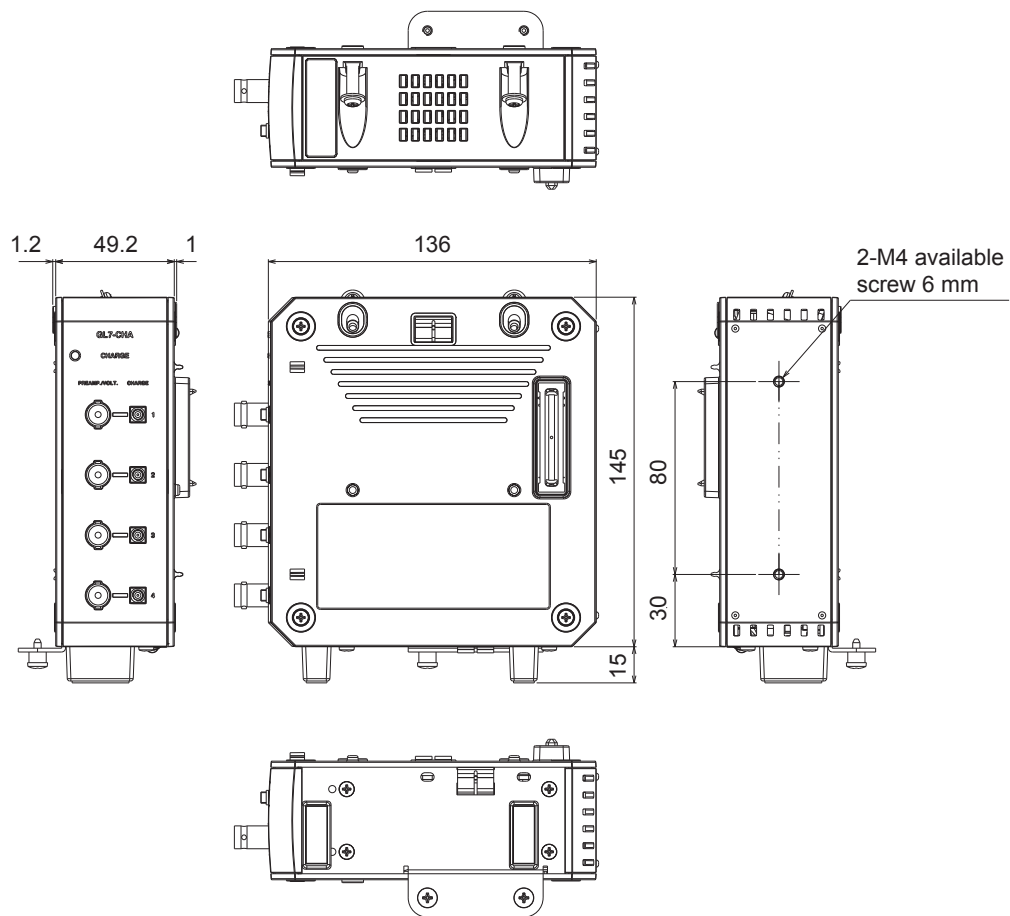

Unit: mm
Dimensional accuracy: ± 5 mm

Voltage Output Module (GL7-DCO): Optional

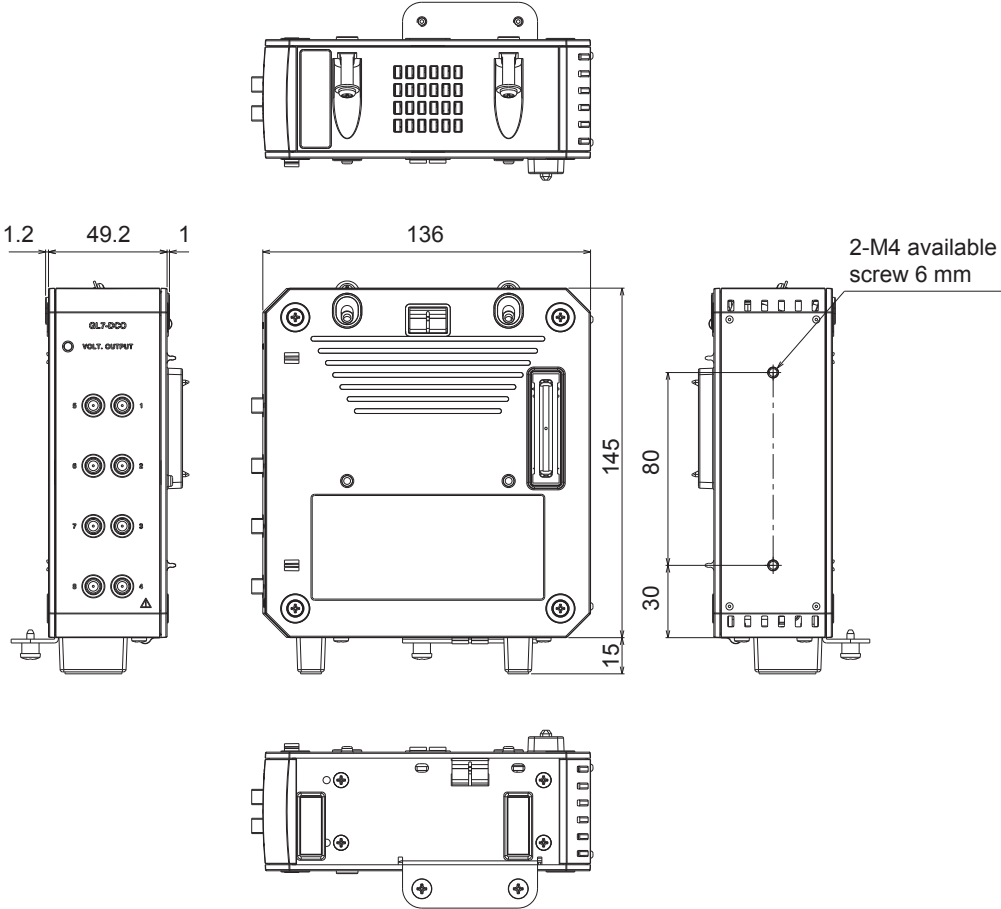

Unit: mm
Dimensional accuracy: ±5 mm

INDEX

Sign

2 screen replaying **3-46**

A

A-cursor **3-138**
 Accessories **2-2, 4-20**
 AC Line cycle **3-76**
 AC Line filter **3-50**
 AC power **2-28**
 Action screen **3-141**
 Adjust mode **3-74**
 Alarm displays **3-4**
 Alarm hold **3-67**
 Alarm level settings **3-110**
 Alarm port number **3-65**
 Amplifier Module Specifications **4-9**
 Amplifier settings **3-8**
 Amplitude **3-61**
 Annotation **3-101**
 Apply **3-73**
 Auto save **3-52**

B

B-cursor **3-138**
 Backup destination **3-57**
 Backup intervals **3-57**
 Backup settings **3-57**
 Bridge circuit **2-41**
 Built-in flash memory access displays **3-3**
 Burnout alarm **3-67**

C

Caic. settings **3-118**
 Calculation between channels **3-102**
 Call other cursor **3-138**
 Capture point **3-51**
 Changing the Display Language **1-6**
 Channel **3-139**
 Channel displays **3-11**
 Channel type **3-139**
 Charge Module **2-15, 2-42, 4-16**
 Clock **3-5**
 Close button **3-8, 3-10, 3-12**
 Combination **3-106, 3-110**
 Common Process Screens **3-24**
 Connecting the Power Cable **2-28**
 Connection test **3-72, 3-74**
 Connect to Analog Signal Input Terminal **2-30**
 Control software **4-18**
 Cursor **3-8**

Cursor position **3-137**

Cursor sync **3-138**

D

Data load **3-62, 3-63**
 Data points **3-59**
 Data recording functions **4-4**
 Data relapyng screen **3-129**
 Data save **3-54, 3-130**
 Data search **3-139**
 Data type **3-60**
 Data with CSV format **3-143**
 Date **3-73**
 Date/Time settings **3-73**
 Date setting **3-66**
 DCO module settings **3-59**
 DC Strain Module **2-14, 2-37, 4-15**
 Delay **3-61**
 Demo waveform **3-77**
 Destination **3-50**
 Detection of the trigger **3-107**
 Digital displays **3-4**
 Direction keys **3-40**
 Display mode **3-116**
 Display Module **2-6**
 Display module **4-8**
 Display settings **3-114**
 DNS address **3-70**
 Duty **3-61**

E

Each Operating Mode **3-44**
 Edge action **3-106**
 Emergency stop alarm CH output **3-63**
 ENTER **3-40**
 Enter a character **3-26**
 EU **3-100**
 Explanation of symbols used on the equipment **1-6**
 External Input/Output functions **4-7**
 External view **4-21**

F

FFT Display **3-122**
 FFT display **3-125**
 File name **3-59, 3-129, 3-130, 3-132, 3-133, 3-136**
 File operations **3-28, 3-129**
 File type **3-131, 3-136**
 Filter **3-61, 3-97**
 Format **3-119**
 Free running **3-44**

| | |
|--------------------------------|------|
| Frequency | 3-61 |
| FTP server | 3-71 |
| FTP server settings | 3-71 |
| Function buttons | 3-5 |
| Function Module Specifications | 4-8 |
| Function Specifications | 4-4 |

G

| | |
|-----------------------------|------|
| Gateway | 3-70 |
| GL input/output cable | 2-45 |
| GL input and output cabling | 2-46 |
| GND terminal | 2-29 |

H

| | |
|-------------------------------------|------------|
| High-voltage Module | 2-36, 4-13 |
| High Speed Voltage Amplifier Module | 4-11 |
| High Speed Voltage Module | 2-10, 2-33 |
| High voltage Module | 2-13 |
| HOME | 3-39 |
| HOME button | 3-4 |
| HOME screen | 3-7 |
| Humidity sensor: B-530 | 4-19 |
| Hysteresis | 3-108 |
| Hysteresis level | 3-108 |

I

| | |
|---|-------|
| I/F, USB settings | 3-68 |
| ID Name | 3-70 |
| Information | 3-77 |
| Input | 3-91 |
| Input settings | 3-78 |
| Installation location | 2-26 |
| Installation space | 2-26 |
| Installing and removing the Module | 2-17 |
| Installing the amplifier module for measurement | 2-22 |
| Installing the Display Module | 2-17 |
| Install SSD Module | 2-25 |
| Inter-CH operation settings | 3-102 |
| Internal equivalent circuit in input/output circuit | 2-46 |
| Internal memory devices | 4-3 |
| Internet time | 3-73 |
| IP address | 3-70 |
| IP address auto acquire | 3-69 |
| IP settings | 3-69 |

K

| | |
|-------------------|------|
| Keep alive | 3-70 |
| Key-lock | 3-43 |
| Key-lock displays | 3-4 |
| Key click | 3-77 |
| Key Operations | 3-39 |

L

| | |
|---|--------------|
| Language | 3-77 |
| LCD brightness | 3-75 |
| Level | 3-140 |
| Level/Upper limit value/Lower limit value | 3-108, 3-111 |
| Level action | 3-106 |
| Level settings | 3-65 |
| Load | 3-133 |
| LOCAL | 3-42 |
| LOCK | 3-42 |
| Logic/Pulse Amplifier Module | 4-12 |
| Logic/Pulse Module | 2-12, 2-34 |
| Logic settings | 3-65 |

M

| | |
|--|---------------------|
| Machine settings | 3-7 |
| Main module Nomenclature and Functions | 2-4 |
| Marker | 3-56 |
| Marker settings | 3-56 |
| Marking | 3-56 |
| Menu screen | 3-10 |
| Menu tree | 3-13 |
| Mode | 3-107, 3-111, 3-139 |
| Module Specifications | 4-8 |
| Move | 3-138 |
| Move date/time | 3-138 |
| Move position | 3-138 |
| Move to center | 3-137 |
| Move to first | 3-137 |
| Move to last | 3-138 |
| Move to selected position | 3-138 |
| Move to trigger | 3-138 |

N

| | |
|----------------------------------|----------------------|
| Name type | 3-130, 3-132, 3-136 |
| Navigator | 3-7, 3-9, 3-10, 3-11 |
| New line Code | 3-68 |
| Next CH button | 3-12 |
| Next search | 3-140 |
| Noise Countermeasures | 2-48 |
| Nomenclature | 3-2 |
| Notes on Temperature Measurement | 1-5 |
| Notes on Using the Monitor | 1-5 |
| NTP server | 3-74 |
| Number of pulses per revolution | 3-92 |
| Numerical entry | 3-24 |

O

| | |
|------------------------|-----------|
| Offset | 3-61 |
| Operate the XY display | 3-121 |
| Operating Environment | 1-3 |
| Optional Accessories | 2-3, 4-20 |

- Optional Modules 2-2
 - Other settings 3-75, 3-103
 - Output 3-111
 - Output level at the time of Stop 3-63
 - Output range 3-61
 - Output sampling interval 3-59
 - Output settings 3-58
 - Output settings (DCO module settings) 3-144
 - Output source 3-59
- P**
- Pass word 3-71
 - PASV Mode 3-71
 - PC I/F 4-3
 - Pen display 3-5
 - Phase 3-61
 - Port number 3-70, 3-71
 - Power on start 3-75
 - Pretrigger points 3-67
 - Prev. search 3-140
 - Previous CH button 3-12
 - Pulse span settings 3-117
- Q**
- QUIT 3-42
- R**
- Range 3-93
 - Read from the output source 3-60
 - Recording 3-45
 - Recording bar 3-6
 - Record settings 3-48
 - Remote displays 3-3
 - REMOTE Functions 2-47
 - Repeat 3-66
 - Repeat interval 3-66
 - Repeat output 3-63
 - Replay 3-129
 - Replaying 3-47
 - Replay setting screen 3-129
 - Restart network 3-70
 - Ring capture 3-53
- S**
- Safety Precautions ii
 - Sample interval 3-4, 3-49
 - Save 3-131, 3-132, 3-136
 - Save/Load current settings 3-132
 - Save folder 3-57
 - Save Range 3-131
 - Scale display 3-6
 - Scaling settings 3-100
 - Screen saver 3-75
 - Screenshot 3-136
 - SD card access displays 3-3
 - Set the channel to be displayed 3-119
 - Settings Menu 3-48
 - Settings screen 3-11
 - Simple message 3-2
 - Simple Waveform Setting 3-112
 - Slope 3-92
 - Slope of the pulse 3-92
 - Source 3-129
 - Span 3-101
 - Span/Position/Trace 3-113
 - Span settings 3-116
 - SSD access displays 3-3
 - SSD Module 2-8, 4-8
 - Standard accessories 4-18
 - Standard Specifications 4-2
 - START/STOP 3-40
 - Start/Stop 3-106
 - Start/Stop synchronization 3-63
 - Start output 3-62, 3-63
 - Start source 3-65
 - Statistical calculation 3-142
 - Status mark 3-4
 - Stop source 3-65
 - Strain gauge 2-41
 - Subnet mask 3-70
 - Swapping out the SD card 3-134
 - Synchronization function 4-7
 - Synchronized interval 3-74
 - System information 3-77
- T**
- Temperature setting 3-76
 - Tilting table 2-7
 - Time 3-73
 - Time/DIV 3-3, 3-113
 - Time settings 3-66
 - Time zone 3-74
 - Title 3-10, 3-11
 - To Ensure Safe and Correct Use i
 - Touch-panel Functions 3-22
 - Trace settings 3-117
 - Trigger/Alarm settings 3-64
 - Trigger and Alarm functions 4-5
 - Trigger level settings 3-105
 - Turning on the Power 2-28
- U**
- USB Drive Mode 3-41
 - USB Drive mode select 3-68

INDEX

| | |
|---------------------|-------------|
| USB ID | 3-68 |
| User name | 3-71 |

V

| | |
|--------------------------------------|-------------------------|
| Various functions | 4-6 |
| Various icons | 3-8, 3-10 |
| Various setting buttons | 3-12 |
| Voltage/Temperature Module | 2-11, 2-31, 4-10 |
| Voltage Module | 2-9, 2-30, 4-9 |
| Voltage Output Module | 2-16, 2-44, 4-17 |

W

| | |
|-------------------------------------|--------------|
| Waveform + Digital Screen | 3-2 |
| Waveform display | 3-5 |
| Waveform setting | 3-112 |
| Web server functions | 3-146 |
| Weekly settings | 3-66 |

X

| | |
|-------------------------------|--------------|
| XY display settings | 3-120 |
|-------------------------------|--------------|

Z

| | |
|------------------------|---------------------|
| Zone setting | 3-113, 3-117 |
|------------------------|---------------------|

Specifications are subject to change without notice.

GL7000 Series User's Manual

GL7000-UM-154

June 21 2013 1st edition-01

GRAPHTEC CORPORATION

GRAPHTEC