

Coupling Decoupling Networks (CDN)

The TBCDN-M2 is a Coupling Decoupling Network for conducted immunity testing according to IEC 61000-4-6. The TBCDN-M2 is compliant with IEC 61000-4-6 Annex D2. It is designed to inject common mode disturbance signals in the frequency range from 150 kHz to 230 MHz into unscreened AC and DC power supply lines.

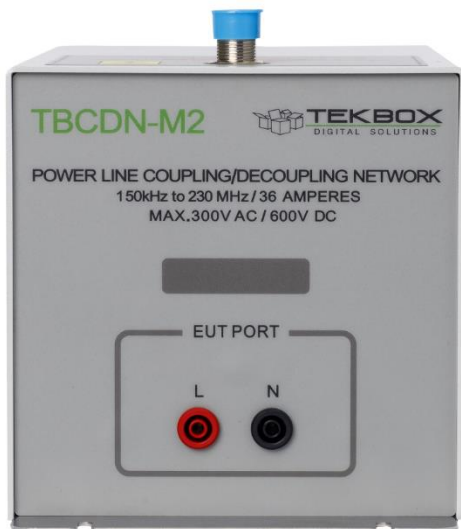

Coupling Decoupling Networks (CDN)

1 Specifications

Maximum supply voltage:	300V AC, 600V DC
Maximum current:	36A
Frequency range:	150 kHz – 230 MHz
Maximum RF input power:	6.5W CW
Maximum RF input voltage:	32 V
Common mode impedance:	150 kHz – 24 MHz: $150 \Omega \pm 20 \Omega$ 24 MHz – 80 MHz: $150 \Omega + 60 \Omega / - 45 \Omega$ 80 MHz – 230 MHz: $150 \Omega \pm 60 \Omega$
Voltage Division ratio:	150 kHz – 80 MHz: $9.5 \text{ dB} \pm 1 \text{ dB}$ 80 MHz – 230 MHz: $9.5 \text{ dB} + 3 \text{ dB} / - 2 \text{ dB}$
RF input connector:	N – female
EUT / AE connectors:	4 mm banana safety jacks, 4mm slots in base plate for GND connection
Housing material:	powder coated aluminium, stainless steel base plate
Dimensions:	300 x 150 x 150 mm
Weight:	ca. 2.5 kg
Included:	individual test protocol with voltage division ratio and common mode impedance
Optional accessories:	30mm adapter panel with shorting bars and N connector 50 Ω to 150 Ω N-male to N-female adapter

2 Informative schematic

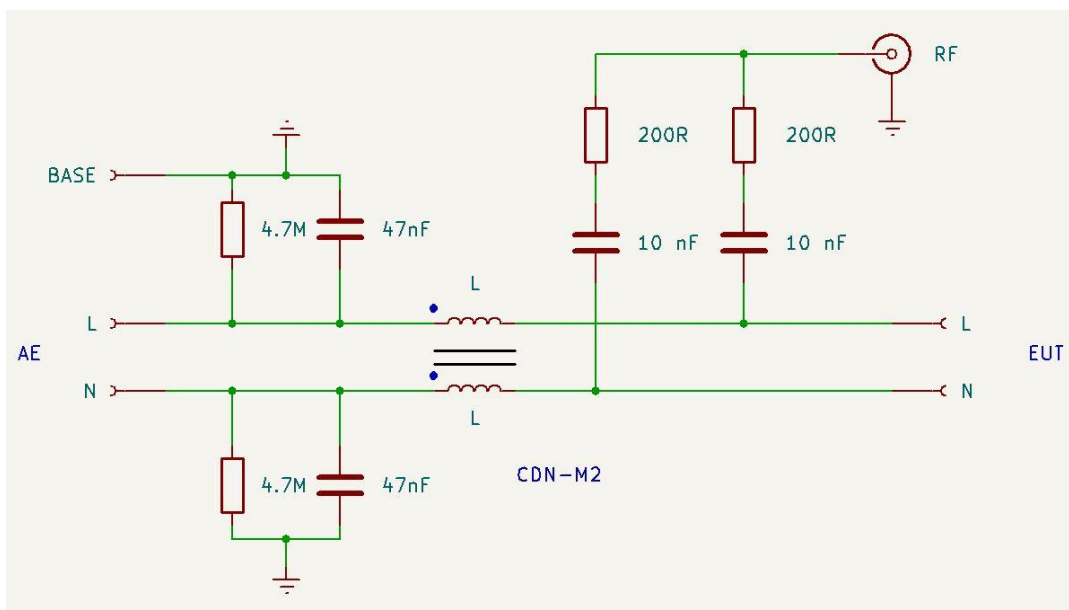

Coupling Decoupling Networks (CDN)

3 Typ. EUT common mode impedance

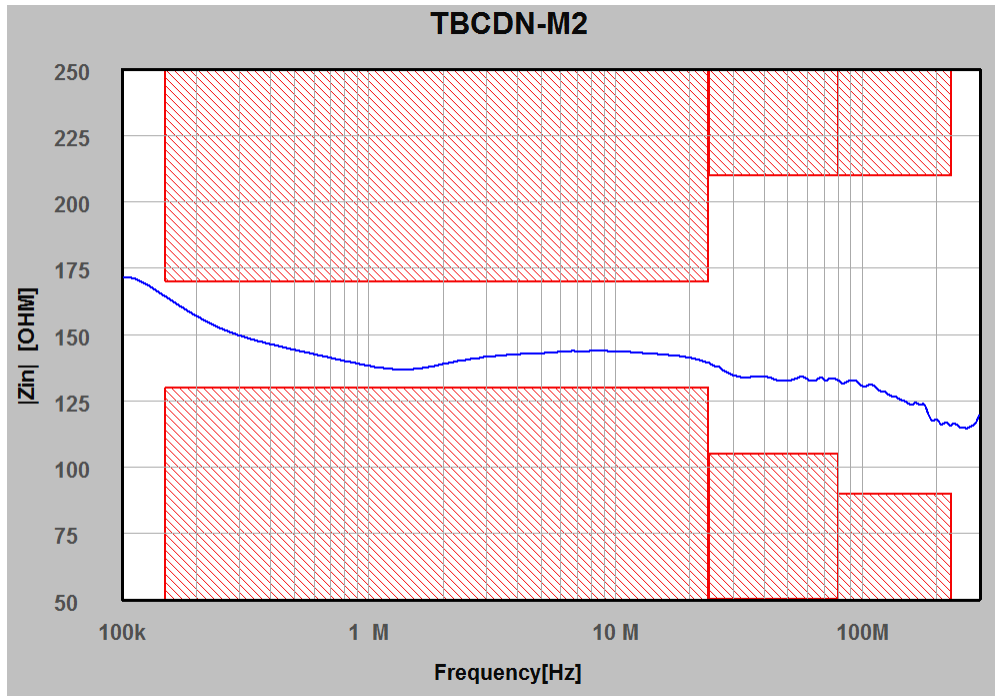

4 Typ. Voltage Division Ratio

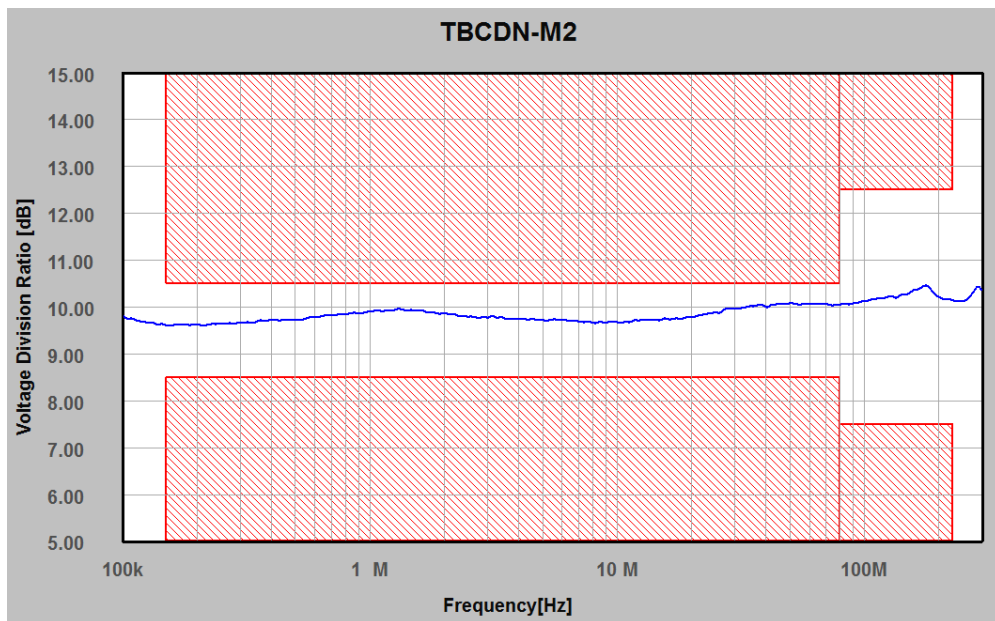

Coupling Decoupling Networks (CDN)

5 EUT Input Phase (common mode, informative)

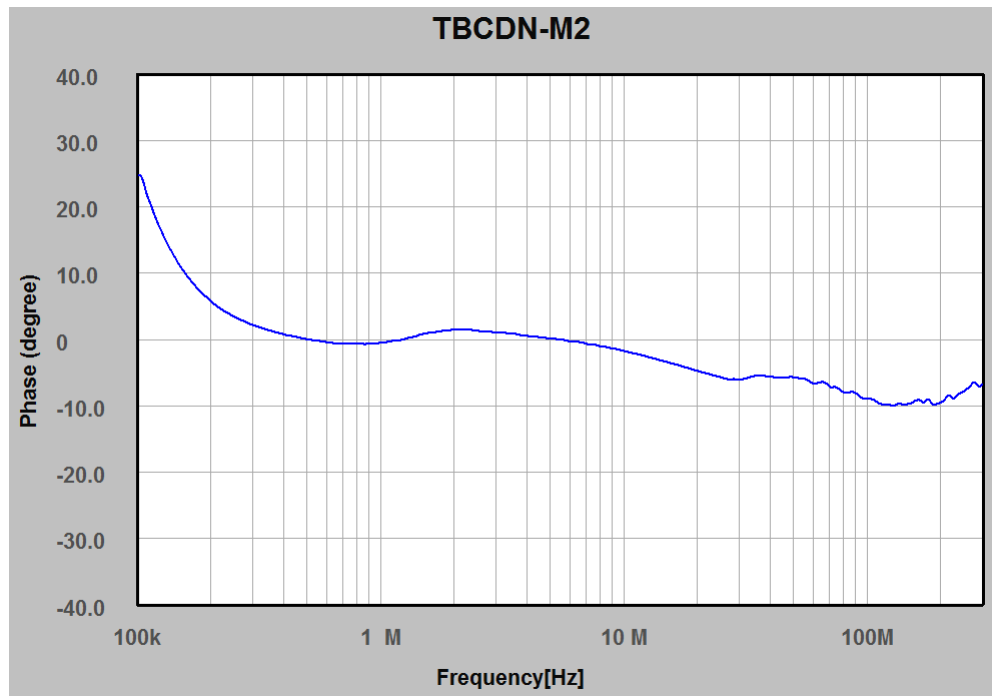

6 Introduction

Similar as LISNs being the central components for conducted emission testing, CDNs are essential for conducted immunity test set ups. CDNs are used to couple RF into cables.

Whereas the CISPR standards specify conducted emission measurements, IEC 61000-4-6 is the main standard for conducted immunity testing. IEC 61000-4-6 specifies three coupling devices:

- Coupling Decoupling Networks (CDN)
Coupling via CDN is the most common test method. It requires least power. It is always used, when appropriate CDNs for the type of signal are available.
- EM Clamps
The EM-Clamp is used, when a CDN is not possible, e.g. for shielded or complex cables. The clamp and the separate decoupling clamp are placed around the cable.
- Bulk current injection clamps
Similar use as EM-clamp. A monitoring of the injected current is strongly recommended.

Coupling and decoupling devices shall be used for appropriate coupling of the disturbing signal (over the entire frequency range, with a defined common mode impedance at the EUT port to the various cables connected to the EUT and for preventing applied test signals from affecting other devices, equipment and systems that are not under test.

The preferred coupling and decoupling devices are the CDNs, for reasons of test reproducibility and protection of the AE. Furthermore, CDNs require significantly lower RF power, to achieve the same test levels, compared to EM clamps or BCI clamps. The main coupling and decoupling device parameter, the common mode impedance seen at the EUT port, is specified in the table below:

Coupling Decoupling Networks (CDN)

	Frequency band		
Parameter	150 kHz – 24 MHz	24 MHz – 80 MHz	80 MHz – 230 MHz
Common mode impedance	$150 \Omega \pm 20 \Omega$	$150 \Omega + 60 \Omega / - 45 \Omega$	$150 \Omega \pm 60 \Omega$

Usage of CDNs:

Line type	Examples	CDN - type
Power supply (AC and DC) and earth connection	AC mains DC in industrial installations Earth connection	CDN - Mx
Screened cables	Coaxial cables cables used for LAN and USB connections cables for audio systems	CDN - Sx
Unscreened balanced lines	ISDN lines telephone lines	CDN - Tx
Unscreened unbalanced lines	Any line not belonging to other groups	CDN – Afx or CDN - Mx

Coupling Decoupling network according to IEC 61000-4-6, example M1, M2, M3:

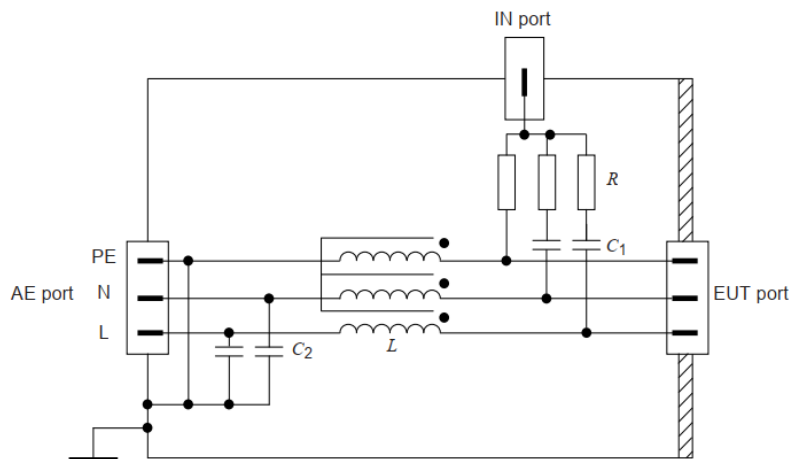

IEC 2627/13

CDN-M3, C_1 (typical) = 10 nF, C_2 (typical) = 47 nF, $R = 300 \Omega$, $L \geq 280 \mu\text{H}$ at 150 kHz

CDN-M2, C_1 (typical) = 10 nF, C_2 (typical) = 47 nF, $R = 200 \Omega$, $L \geq 280 \mu\text{H}$ at 150 kHz

CDN-M1, C_1 (typical) = 22 nF, C_2 (typical) = 47 nF, $R = 100 \Omega$, $L \geq 280 \mu\text{H}$ at 150 kHz

Figure D.2 – Example of simplified diagram for the circuit of CDN-M1/-M2/-M3 used with unscreened supply (mains) lines (see 6.2.2.2)

Coupling Decoupling Networks (CDN)

The performance of the CDN shall not be unduly degraded by saturation of the magnetic material due to current drawn by the EUT. Wherever possible, the network construction should ensure that the magnetising effect of the forward current is cancelled by that due to the return current.

If in actual installations the supply wires are individually routed, separate CDN-M1 CDNs shall be used. All input ports shall be treated separately. If the EUT is provided with functional earth terminals (e.g. for RF purposes or high leakage currents), they shall be connected to the reference ground plane:

- through the CDN-M1 when the characteristics or specification of the EUT permit. In this case, the (power) supply shall be provided through an appropriate CDN-Mx type network;
- when the characteristics or specification of the EUT do not permit the presence of a CDN-M1 network in series with the earth terminal for RF or other reasons, the earth terminal shall be directly connected to the reference ground plane. In this case the CDN-M3 network shall be replaced by a CDN-M2 network to prevent an RF short-circuit by the protective earth conductor. When the equipment was already supplied via CDN-M1 or CDN-M2 networks, these shall remain in operation;
- for a 3-phase supply, a similar adjustment needs to be done regarding the use of an appropriate CDN-Mx type network.

Warning: The capacitors used within the CDNs bridge live parts. As a result, high leakage currents may occur and safety connections from the CDN to the reference ground plane are mandatory.

7 Immunity test set up

The picture below shows a basic conducted immunity test set up. The purpose of the 6 dB attenuator is improved impedance matching between RF power amplifier and CDN:

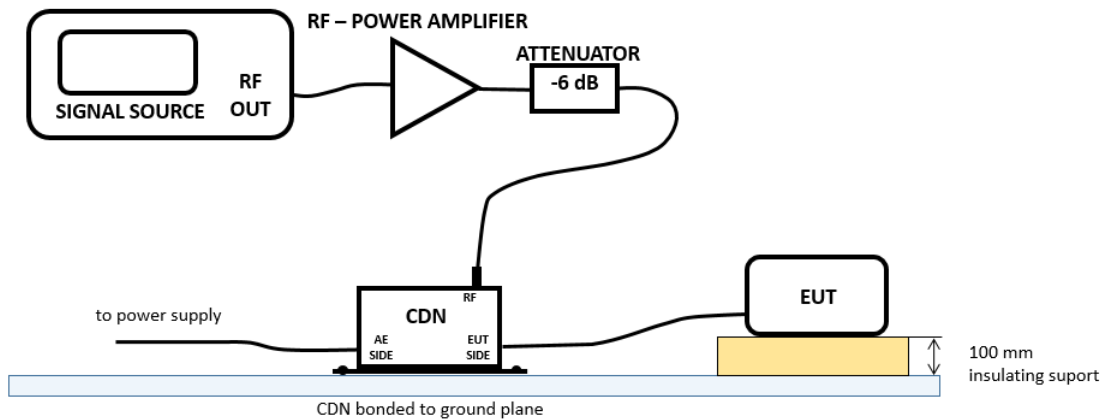

Following test levels are specified:

Level	Voltage level (e.m.f.)	
	U_0 [V]	U_0 [dB μ V]
1	1	120
2	3	129.5
3	10	140
X*	Special	
* "X" can be any level, above, below or in between the others. The level has to be specified in the dedicated equipment specification		

Coupling Decoupling Networks (CDN)

The test levels are set at the EUT port of the coupling devices. For testing of the equipment, this signal is 80 % amplitude modulated with a 1 kHz sine wave to simulate actual threats. The effective amplitude modulation is shown below:

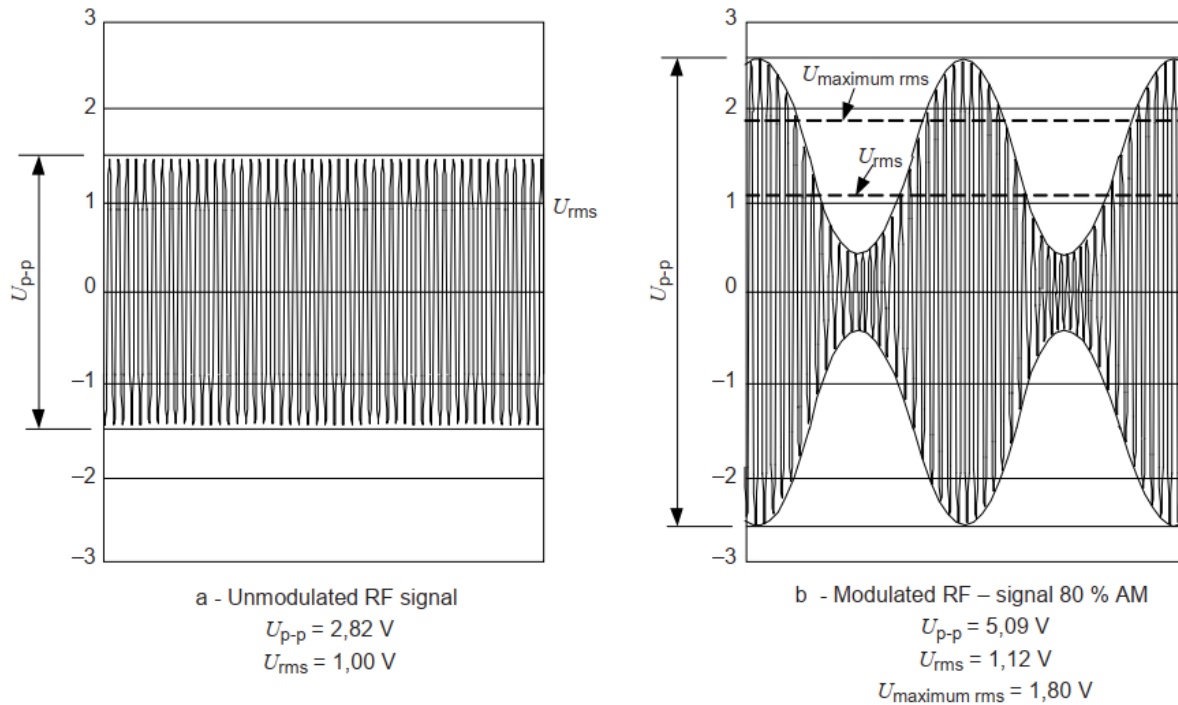

Consequently, the level of the modulated signal must be 5.1 dB higher than the test levels specified by the standard. Adding a 6dB attenuator to improve matching of the RF power amplifiers would require following amplifier output power:

Level	unmodulated rms voltage	modulated rms voltage	unmodulated RF power	modulated RF power	Including 6 dB attenuator
1	1 V	1.8 V	20 mW / 13 dBm	64.8 mW / 18.1 dBm	257 mW / 24.1 dBm
2	3 V	5.4 V	180 mW / 22.6 dBm	589 mW / 27.7 dBm	2.34 W / 33.7 dBm
3	10 V	18 V	2 W / 33 dBm	6.48 W / 38.1 dBm	25.7 W / 44.1 dBm

The standard test frequency range is 150 kHz – 80 MHz, with certain device classes being tested from 150 kHz – 230 MHz.

The table below shows a comparison of the required power for level 3, using different coupling methods. These power levels do not consider any 6 dB attenuator.

Transducer type	Required output power from RF amplifier
CDN	7 W
BCI - clamp	176 W
EM - clamp	28 W

Coupling Decoupling Networks (CDN)

8 Calibration

Frequency range:

Although the requirements in the standard are specified for the frequency range 150 kHz up to 80 MHz, the applicable frequency range depends on the normal installation and operation conditions of the equipment to be tested. In general, the stop frequency will be 80 MHz. In some cases, where small-sized equipment is considered (dimension $< \lambda/4$), dedicated product standards may prescribe that the stop frequency is extended up to a maximum of 230 MHz. When using this test method up to higher frequencies, results are influenced by: the size of equipment, the type(s) of interconnecting cables used, and the availability of special CDNs, etc. Further guidance for proper application should be supplied in the dedicated product standards.

On the other hand NAMUR NE 21 extends the applicable frequency down to 10 kHz.

Set up:

- The test generator (RF out) shall be connected via the 6 dB-attenuator to the RFinput port of the CDN.
- The EUT port of the CDN shall be connected in common mode via a 150 Ω to 50 Ω adaptor to a measuring equipment having a 50 Ω input impedance.
- The AE-port shall be loaded in common mode with a 150 Ω to 50 Ω adaptor, terminated with 50 Ω .

The assembly is outlined below.

With direct injection to screened cable (CDN-S types), the 150 Ω load at the AE-port is not required as the screen will be connected to the ground reference plane at the AE-port side.

With the CDN M-types, CDN AF-types and CDN T-types the 150 Ω connector is according to standard prescribed, yet the calibration values for these CDN types are virtually independent of the load. This is due to the fact that these types have capacitors against ground at the AE-port side, which generate a RF-short circuit, comparable to those of the S-types.

Thus with the CDN M-types, CDN AF-types and CDN T-types the load of 150 Ω at the auxiliary equipment connector can be dispensed with.

In order to calibrate a CDN you require:

- specific calibration adapters
- ground plane exceeding the length of the CDN 20 cm on each side
- 150 Ω to 50 Ω adapters

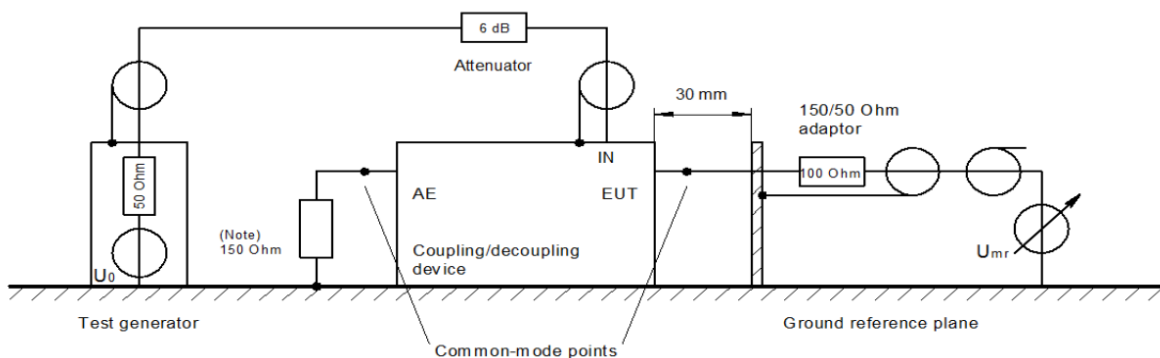

Coupling Decoupling Networks (CDN)

CDN common mode impedance measurement set up:

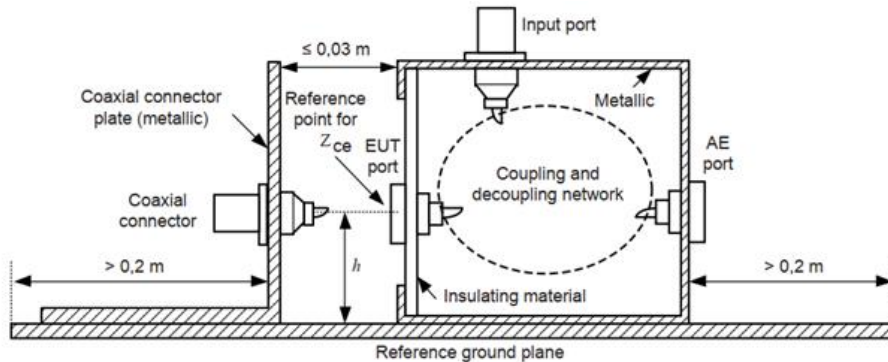

IEC 2597/13

- Reference ground plane: shall exceed the projection of the coupling and decoupling devices and other components by at least 200 mm.
- The coaxial connector shall be connected horizontally to the EUT port.
- The height h of the EUT port depends on the individual CDN, which may vary from 30 mm to 100 mm; particular large current CDNs have an EUT port located higher above the reference ground plane.
- Connector plate (with the coaxial connector): 100 mm × 100 mm for $h = 30$ mm and 150 mm × 150 mm for other values of h .
- Both connector plates shall be made out of copper, brass or aluminium and shall have a good RF contact.

The input port is terminated with 50 Ω. The impedance requirement shall be met with the AE port open or shorted to ground.

CDN common mode impedance values:

150 kHz – 24 MHz: 150 Ω ±20 Ω
 24 MHz – 80 MHz: 150 Ω +60 Ω /-45 Ω
 80 MHz – 230 MHz: 150 Ω ±60 Ω

Voltage division factor

Measurement set up:

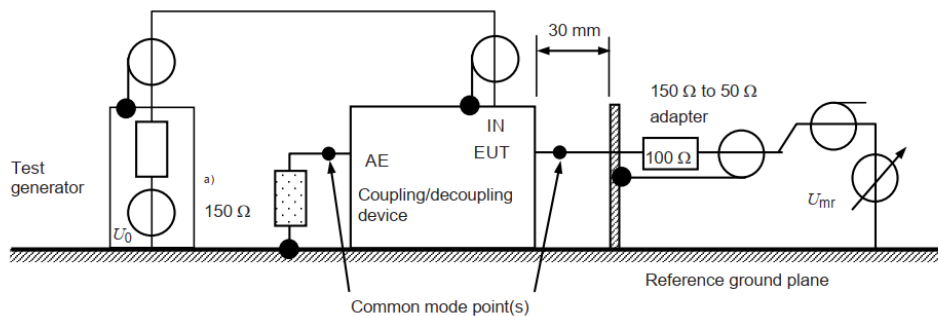

Voltage division factor RF-port to EUT-port:

150 kHz – 80 MHz: 9.5 dB ± 1dB
 80 MHz – 230 MHz: 9.5 dB +3 dB / - 2 dB

Coupling Decoupling Networks (CDN)

9 Ordering Information

Part Number	Description
TBCDN-M2	M2 coupling decoupling network
TBCDN-M2-AP	Adapter panel with shorting bar for M2 coupling decoupling network
TBCDN-50-150	50 Ω to 150 Ω N-male to N-female adapter

10 History

Version	Date	Author	Changes
V1.0	24.3.2022	Mayerhofer	Creation of the document