

MODEL 62000D SERIES

KEY FEATURES

- Voltage rating : 0~100V/600V/1200V/1800V/2000V
- Current rating : 0~540A
- Power rating : 6kW/12kW/18kW@3UH 36kW/45kW@4UH
- Dual output ranges in one-click switching (62000D-HL models)
- Two-quadrant operation : source and load functions
- High power density : 45kW in 4U
- Easy master/slave parallel & series^{*1} operation up to 540kW
- Wide range of voltage & current combinations in constant power
- Auto sequencing programming
- Voltage & current slew rate control
- High speed transient response <1.5ms
- Low output noise and ripple
- Standard USB/LAN/APG interfaces, optional CAN/CAN FD/GPIB interfaces (CAN FD is supported on 2000V models)
- Solar array simulation function^{*2} (optional)



PROGRAMMABLE BIDIRECTIONAL DC POWER SUPPLY MODEL 62000D SERIES

Chroma 62000D Series programmable bidirectional DC power supplies have both power source and load characteristics. Capable of feeding power from the device under test (DUT) back to the utility grid, these two-quadrant power supplies are ideal for testing energy storage systems in renewable energy applications such as solar PV/storage hybrid inverters, battery power conditioning systems (PCS), and simulating charging and discharging of energy storage batteries. 62000D also has applications in testing power components in electric vehicles (EVs) as well as bidirectional on-board chargers (BOBC), DC-DC converters, and DC-AC motor drivers, enabling bi-directional power conversion simulation tests without the need for actual batteries.

Traditional DC power supplies need protection diodes to prevent back EMF from damaging the power supply during motor testing. However, 62000D bidirectional DC power supplies can drive the motor and also efficiently regenerate EMF to the grid, avoiding the need for blocking diodes while saving space, energy, and configuration effort. In addition, the fast transient response of the 62000D enables seamless quadrant changing in less than 1.5ms (-90% to +90% load).

The 62000D series is available in 3U and 4U form factors, all boasting high power density. The 3U models come in single-unit output power ratings of 6kW/12kW/18kW, while the 4U models have single-unit output power rated 36kW/45kW. The 62000D-HL

model features unique dual-range output capability, allowing a single unit to provide both High (2000V/60A/45kW) and Low (650V/180A/45kW) output ranges. This enables the unit to meet high-current, full-power test conditions of the DUT while also meeting high-voltage, full-power test requirements, suitable for wide-ranging testing needs such as the 400V and 800V battery platforms used by EVs and EV supply equipment (EVSE).

The 62000D series supports up to 100 programmable sequences through its List Mode feature. Its fast transient response time meets many testing needs, including those defined in the LV123 and LV148 standards for EV components. When used with Chroma's Softpanel software, users can conveniently conduct complex tests with a simple press of a button.

The 3U models have a universal 200-480Vac input voltage and the 4U models have a universal 380-480Vac input voltage. All units have active PFC low current harmonic feedback, which significantly reduces electricity costs and power system configuration in high power test environments, lowers test environment temperature, and is suitable for power systems in all regions globally. Various control methods are available, supporting digital USB/LAN/CAN/GPIB interfaces and analog APG interface control, with the 2000V models additionally supporting CAN FD.

- *1: 100V/600V models support series operation. 1200V/1800V (18kW) models support parallel operation up to 540kW.
- *2: This function supports 600V/1200V/1800V/2000V models

APPLICATIONS

- Charge/discharge testing and life cycle testing, including BOBC, DC-DC conversion, and PCS
- Motor driver testing
- Pre-compliant with LV123 and LV148 standards on electrical car components testing
- Used as battery simulation source for microgrid applications
- Suitable for 1500V string PV inverter testing



Chroma
Advancing Excellence

POWER CONVERSION TESTING OF ELECTRIC VEHICLES AND MICROGRID STORAGE

Renewable energy technologies such as photovoltaics (PV), EVs, fuel cells, and batteries are rapidly gaining traction as replacements for traditional energy sources like coal and oil. These technologies demand more electricity, which in turn has caused microgrids to emerge as a critical component of the modern power grid. The bidirectional design of power conversion devices pushes battery applications toward achieving higher efficiency, voltage conversion, and power density, prompting the need for battery simulation (bidirectional power supply) testing designs.

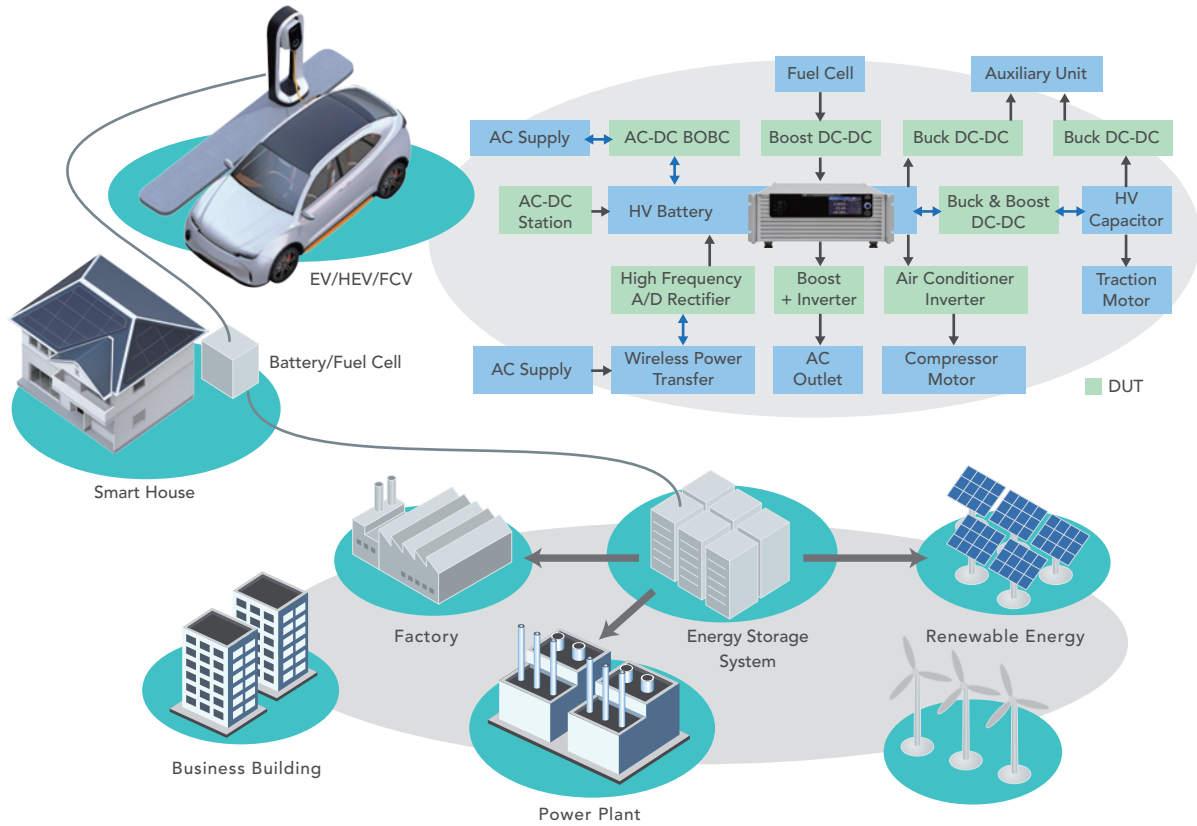

With the widespread use of EVs, there is also a corresponding demand for sound residential, commercial, and city charging networks. This has resulted in a smart grid and energy storage system ecology—from 5kW-30kW smart home charging/storage systems, to 30kW-500kW integrated commercial PV/storage/charging stations, to dispersed large-scale MW-level storage combined with renewable energy sources like solar, wind, and fuel cells. With voltage systems for these high power applications also developing toward 1500V-2000V, battery simulation equipment for related power conversion devices also needs to meet these voltage and power requirements.

As for the test equipment needs of high power conversion devices like PCS, ESS, chargers, and inverters, users often need to consider factors like size, weight, equipment utilization rate, flexible disassembly/re-assembly into multiple power systems for flexible scheduling, and system fault maintenance time affecting R&D and production. The 62000D-HL bidirectional DC power supply features master/slave parallel control capabilities. Single-unit parallel operation is simple and fast. Integrated into a cabinet, these power supplies are suitable for testing string-type PV inverters, able to separately supply multiple MPPT inputs, or quickly parallel to high power input—convenient for use in R&D labs, validation units, and production lines.



62450D-2000HL
Master/Slave Parallel in a Single Cabinet up to 360kW
* Please call for more information

NEXT-GENERATION 62000D-HL MODEL FEATURES HIGH POWER DENSITY 45KW@4UH AND DUAL OUTPUT RANGES IN ONE-CLICK SWITCHING

With the maturation of SiC semiconductor devices and the gradual increase in charging standard voltages, EVs are developing toward improved charging efficiency and range by evolving their battery platforms from 400V to 800V. This in turn is driving up the voltages for on-board electrical control systems like BOBC, DC-DC, motor control units (MCUs), and inverters.

Taking a 22kW bidirectional on-board charger (BOBC) compatible with both 400V and 800V as an example, the typical voltage range would be 200V-900V or even higher. The design of the test equipment must account for rated test conditions as well as over-voltage (>130%) protection test margins. Generally, the maximum charging current falls within the 200V-450V range, so current also needs to consider ripple peaks and over-current (>120%-150%) protection test ranges. Under such an operating range, users may need one high-voltage bidirectional DC power supply over 1200V, as well as another with at least 120A current capability. The Chroma 62000D-HL model satisfies this ultra-wide operating range requirement with a single device.

The 62000D-HL bidirectional DC power supply features two ultra-wide output ranges within a single unit. For the 62450D-2000HL model, the High range provides 2000V/60A/45kW, while the Low range offers 650V/180A/45kW. Users can easily switch between the needed ranges to meet test conditions requiring either high voltage or high current. With such a wide operating range, in addition to the High range satisfying high voltage test points, users can even utilize the Low range's high current capability in load mode to perform long-term reliability testing on two devices under test with a single piece of equipment.

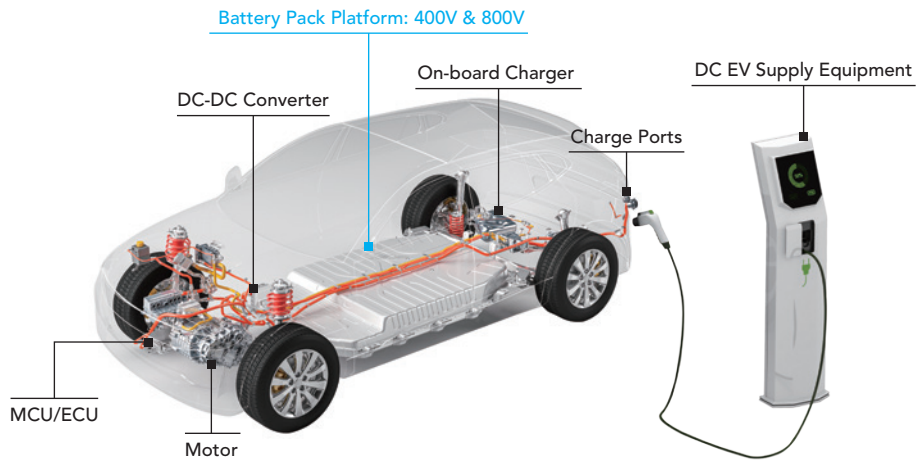
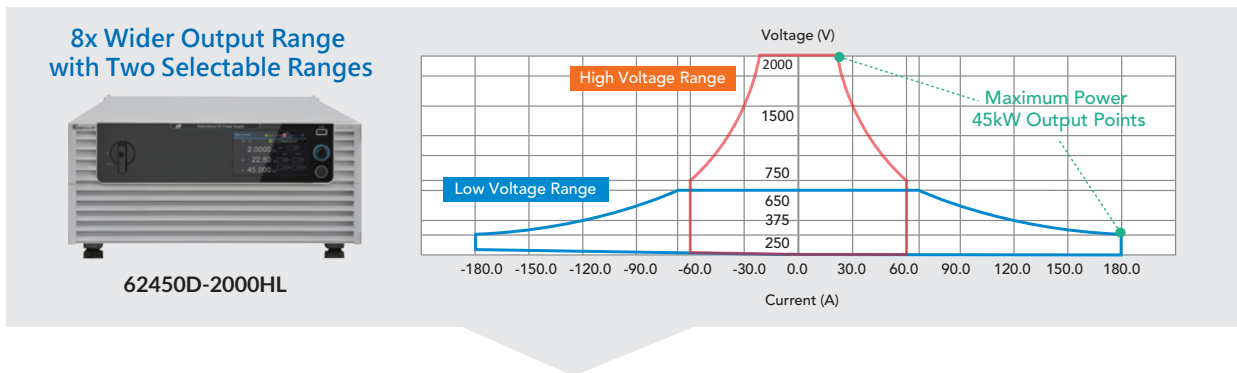

Users can switch between the 62000D-HL model's dual output ranges by simply pressing the switch on the front panel touchscreen, or by sending a remote command. In an automated test equipment (ATE) production line system, only one 62450D-2000HL is needed - switching between the High/Low ranges via command satisfies both output range operations. After switching, the test instructions can proceed without interruption. Users do not need additional manual disassembly/re-assembly of bridging fixtures at the equipment output terminals, making for a seamless and safe testing experience.

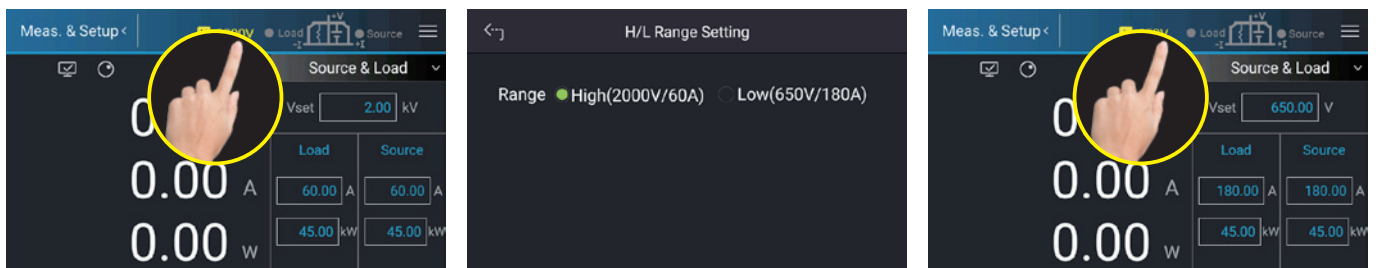

TWO-IN-ONE: BIDIRECTIONAL DC POWER SUPPLY AND LOAD

The Chroma 62000D boasts a bidirectional switch-mode power supply design that offers two-quadrant operation with positive current/positive voltage as well as negative current/positive voltage, enabling both DC power supply output and regenerative DC load. The absorbed energy is fed back to the grid with up to 93% efficiency and can operate in constant voltage (CV), constant current (CC), and constant power (CP) mode. Compared to a traditional power supply and load, the 62000D two-in-one bidirectional DC power supply saves space, reduces energy loss and heat dissipation, and is easier to wire and configure.

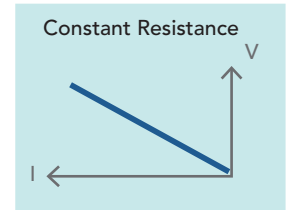
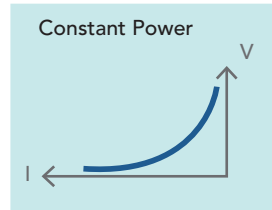
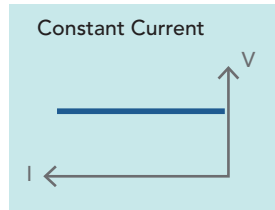
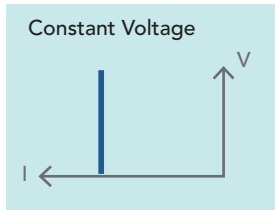
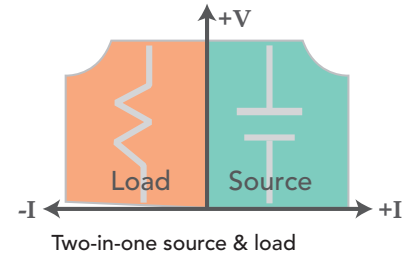

Electrical load functions

Today's electric cars typically carry on-board chargers that manage power flow bidirectionally between the vehicle and the grid for operations such as V2G (Vehicle to Grid), V2L (Vehicle to Load), and V2H (Vehicle to Home). The 62000D also offers a pure electronic load mode with constant current (CC), constant power (CP), and constant resistance (CR) control, especially useful for simulating battery charging behavior during development and testing of BOBCs. In contrast to traditional methods requiring separate instruments for DC power supply and regenerative DC load, a single Chroma 62000D unit now suffices for conducting both charging and discharging tests autonomously.

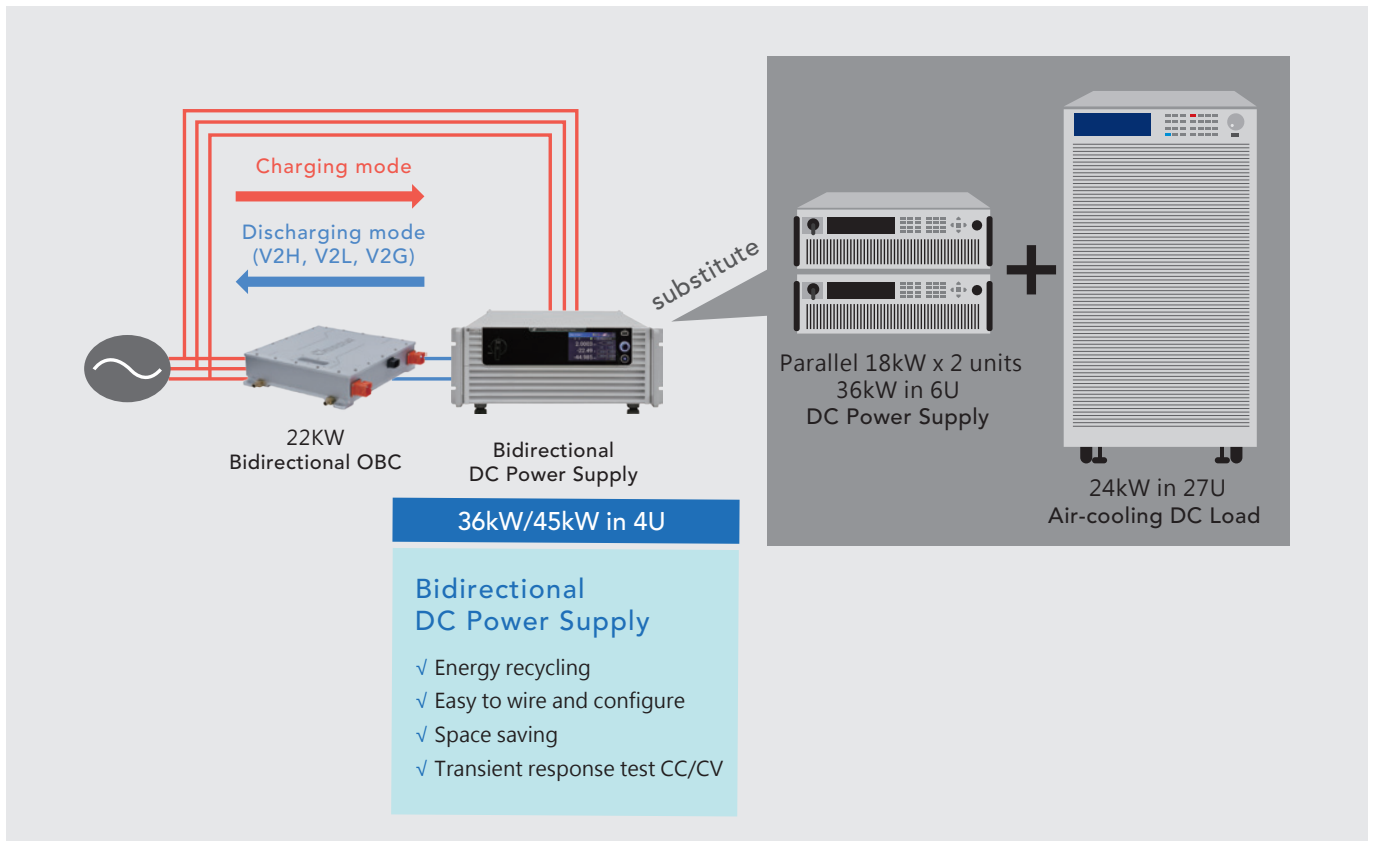

Bidirectional on-board charger testing configuration

FAST TRANSIENT RESPONSE <1.5MS

Chroma 62000D allows seamless current conversion between the two quadrants of supply and electrical load without compromising output characteristics or causing damage. In many bidirectional DC-DC and DC-AC battery charge/discharge tests demanding rapid transition between charging and discharging, the 62000D's high-speed transient response proves invaluable, boasting an output voltage response time of less than 1.5ms for a -90% to +90% load change.

To assess acceleration and braking of the motor driver under real-world driving conditions, the conversion between battery and power components will involve supply and recharge of electrical energy. The 62000D's fast transient response across two quadrants adeptly simulates the battery according to the actual needs of the motor, offering stable voltage and enabling current recharge during braking.

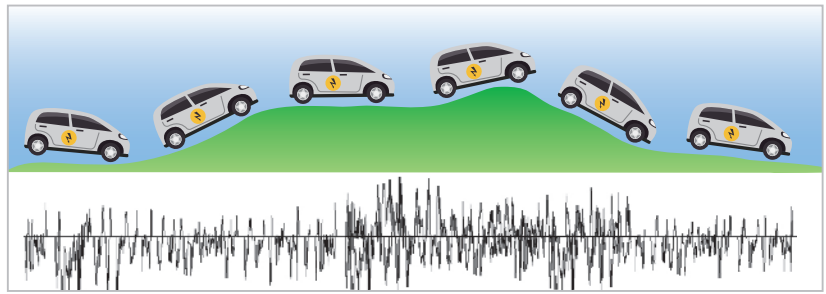

Simulation of actual driving conditions

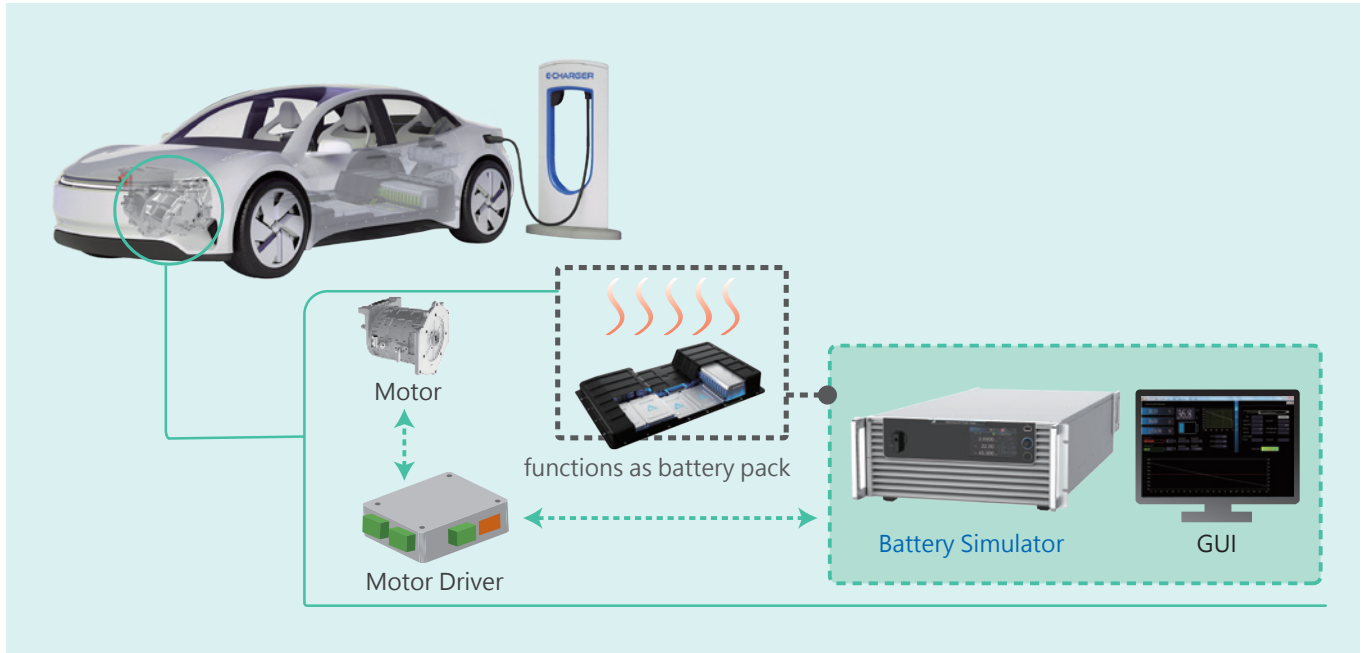

Start-stop system motor driver test application

TESTING STANDARDS LV123 AND LV 148

Driven by global energy efficiency and carbon reduction trends, the auto industry has established technical development standards that define tests for a variety of electric vehicles. The LV123 standard specifies the electrical characteristics and safety standards for high-voltage components, while the LV148 covers tests for electric and electronic components in 48V electrical system motor vehicles. Chroma 62000D has a high-speed CV dynamic response slope that can be controlled up to 200V/ms, applicable to the electrical characteristics tests of many vehicle standards. When used with the Chroma Softpanel, users can execute all these tests effortlessly at the push of a button.

The diagram shows a Chroma 62000D power supply connected to a car. Above the car are four graphs representing different test waveforms: a step function, a pulse, a ramp, and a high-frequency oscillation. The Chroma 62000D is connected to the car via a dashed line, indicating the test setup.

LV148

- Long-term overvoltage
- Transient pulse in the lower operating range
- Recuperation
- Slow reduction and slow increase of supply voltage
- Reset behavior
- Operation in the upper range with functional restrictions
- Operation in the lower range with functional restrictions
- Overvoltage range

LV123

- Range of unlimited operating capability
- Range of upper limited operating capability
- Range of lower limited operating capability
- Range of highly limited operating capability

BATTERY SIMULATION FUNCTION

The 62000D serves as a bidirectional DC power supply capable of being charged or discharged by an external power source. When used with software, 62000D units become battery simulators that can replicate operation at various capacities (SOC) or import specific battery characteristics V-I curves. This capability facilitates product evaluation under diverse battery capacities and characteristics. Suitable for testing an array of products like BOBC, PCS, ESS, or motor drivers, the 62000D series offers a versatile solution for battery simulation needs.

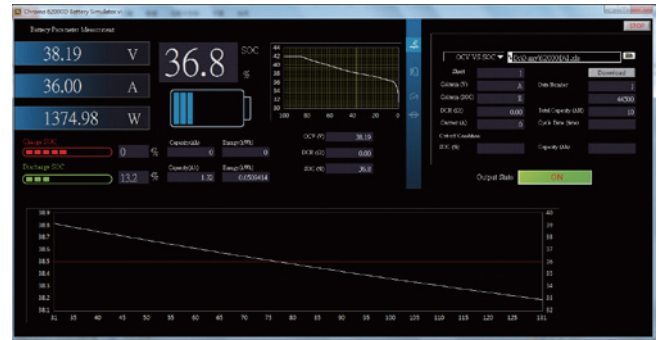

BATTERY CHARGE-DISCHARGE MODE

The 62000D bidirectional DC power supply offers source and load operations, with a typical application being to test the electrical CC-CV characteristics of batteries. When verifying battery specifications, it's necessary to conduct tests under standard charging and discharging conditions, including capacity tests after charging and discharging at various temperatures, as well as End-of-Line (EOL) charging and discharging test parameters. All these tests can be easily executed using the 62000D alone. Catering to common EV/HEV batteries ranging from 12V/24V/48V low-voltage battery packs to 200V/400V/800V high-voltage battery packs, the voltage and current ranges of the 62000D comprehensively cover various testing applications. The 62000D also features a built-in Charge-Discharge mode tailored for batteries, which can measure battery voltage and current and calculate battery capacity (Ah). Users can conveniently implement cycling or auto-stop charge and discharge tests by setting cut-off conditions.



* When connecting the 62000D to the battery, it is necessary to add a safety pre-charging circuit to avoid inrush current to protect the battery and equipment. For more information, please contact your local Chroma office.

SOLAR ARRAY SIMULATION FUNCTION (OPTIONAL)

The 600V/1200V/1800V models have built-in EN50530 and Sandia SAS models that allow users to easily program different solar cell I-V characteristic outputs via the front panel or remote SCPI control. The SoftPanel software includes static & dynamic MPPT test, shadowed I-V curve simulation, real-world weather-based I-V curve variation testing, and automatic static & dynamic MPPT tests with report generation in Excel format, ideal for validating the performance of series-connected PV inverters. Additionally, the 62180D-1200 and 62180D-1800 models support master/slave parallel configuration of up to 30 units, with output specifications reaching 540kW/1200V/1200A & 540kW/1800V/1200A respectively. This enables adaptation for testing high-voltage 1100V and 1500V commercial (15k-100kW) string inverters and distributed energy resource (150k-500kW) inverters.

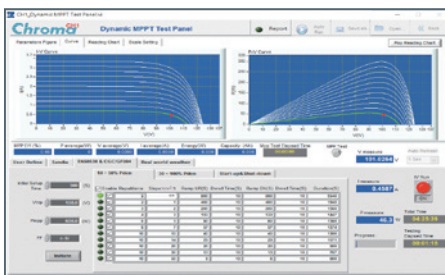

EN50530 & Sandia Dynamic MPPT Test



Static MPPT Test

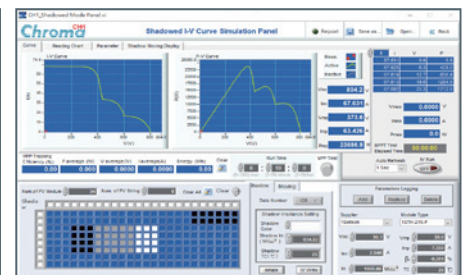

Shadow I-V Curve Simulation

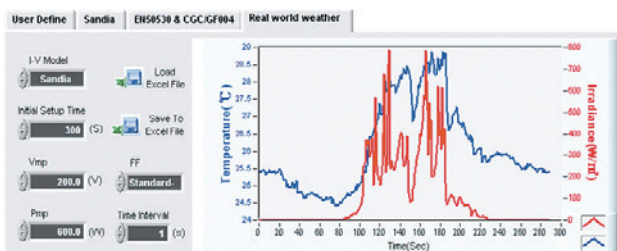

Real World Weather Simulation

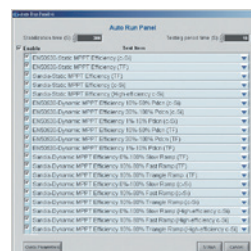

Auto Run Report

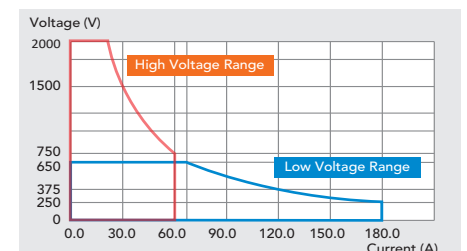

62180D-1800 Operating Region in Source Mode

HIGH VOLTAGE PCS TESTING

A power conditioning system (PCS) serves to facilitate bidirectional power conversion between battery systems and the grid, with the latest devices boasting terminal battery voltages of up to 1500V, featuring charge/discharge functionality, active power control, reactive power regulation, and off-grid switching. A common issue for users is how to prepare an actual high-voltage battery for testing the charge/discharge transition performance of PCS units, typically with a standard transition time of <100ms. Achieving this level of performance while ensuring R&D verification, manufacturing reproducibility, controllability, and safety can be daunting. With the high-voltage 62180D-1800 model, users can parallel up to 30 units to achieve an output of 540kW/1800V/1200A. This setup effectively replaces real battery simulation as either a power supply or regenerative load, allowing for continuous transient response testing with an uninterrupted flow of current.

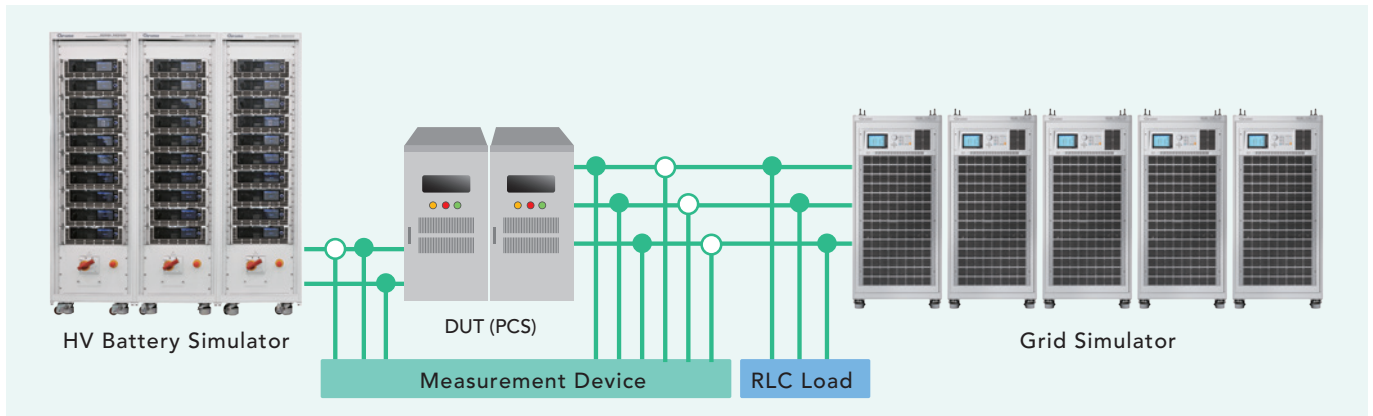

SAFETY AND AC FAULT PROTECTION

Chroma 62000D bidirectional DC power supplies have energy recycling functionality that returns energy to the grid. The internal protection design serves to identify input voltage and frequency anomalies. When detecting any anomalies, the 62000D will automatically turn off the output to ensure safe use of the grid. The 62000D is set up with OVP, OCP, OPP, OTP, Fan Fail, and AC Fault protection circuits. AC Fault protection includes OVP, UVP, Unbalance, Freq. Error, and OCP.

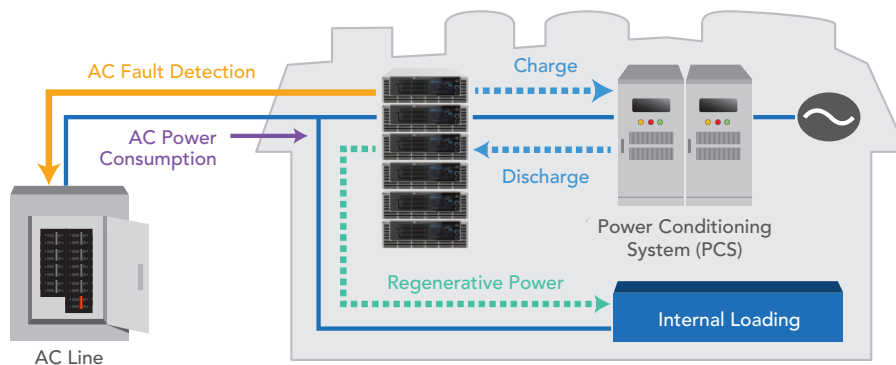

HIGH POWER SYSTEM INTEGRATION

Chroma offers high-power bidirectional power supply integration services ranging from 54kW to 540kW/1800V/1200A systems. These power systems come with multiple protections, including AC circuit breaker with overcurrent protection, leakage current detection, emergency stop button device, input voltage phase deficiency, over-voltage, under-voltage, system over-temperature, and fan failure protection. They are suitable for both R&D purposes and long-term testing on production lines.



* Model 62180D-1200 & 62180D-1800 can support 30 units in parallel, up to 540kW. For parallel requirements of models 62360D-2000HL & 62450D-2000HL, please contact your local Chroma office.

ADVANCED ULTRA-WIDE OUTPUT RANGE

For testing of 11kW BOBC, taking into consideration maximum current ripple, inrush currents generated during vehicle DC-DC startup, etc., the test equipment must be able to provide approximately 20%-50% current margin beyond the steady-state charging current specifications. Therefore, for models 62120D-1200 and 62180D-1200, Chroma has further enhanced the current capability under ambient temperature conditions and for specific versions, achieving an output range of 1200V/55A/13kW-19.5kW.

For string PV inverter test applications, to cover residential to commercial power needs including 1.5x overdimensioning, the maximum short-circuit current per MPPT channel has been gradually increasing. Facing this equipment demand, the current provided per MPPT channel also gets a boost. For the 62180D-1800 model, the voltage meets the needs of 1100V and 1500V systems, while the current has been enhanced to 55A. Under ambient temperature conditions and for specific versions, the output range reaches 1800V/55A/19.5kW. Please refer to the specification sheets for related conditions.

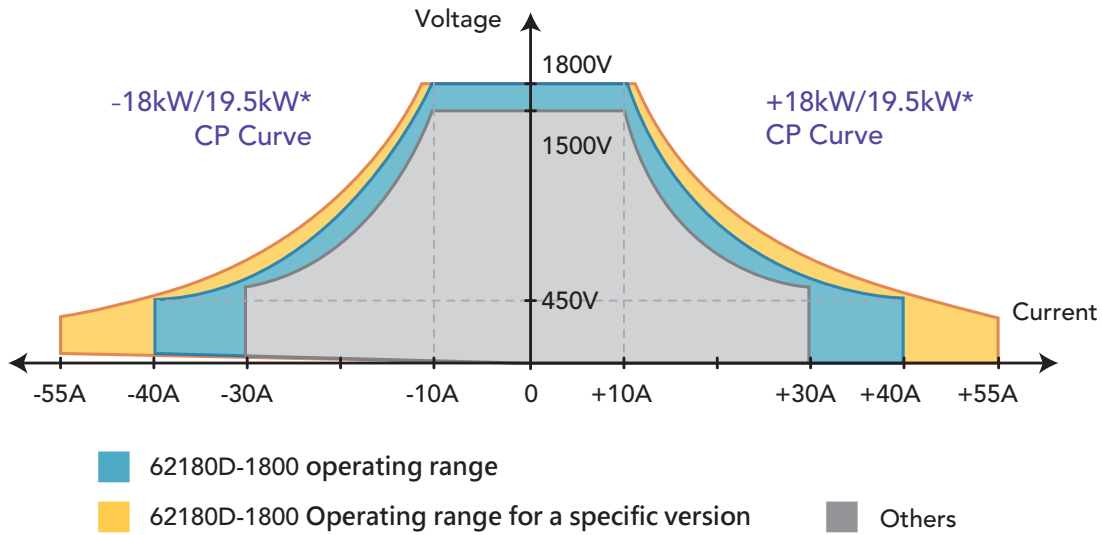

UNIVERSAL AC POWER RANGE 200~480VAC

Chroma 62000D bidirectional DC power supplies are equipped with an active PFC >0.97 for low energy consumption and high conversion efficiency. Moreover, to fit the universal AC power input range, the 62000D series has a very wide input power range of three-phase 200-220Vac and 380-480Vac. Users can purchase one single device without having to configure it for use in other areas.

* Models 62360D-2000HL and 62450D-2000HL have an input voltage range of 3-phase 380-480Vac.

REMOTE CONTROL

Chroma 62000D supports various communication interfaces, allowing users to connect and control the unit via standard USB, LAN, and optional GPIB interfaces with a PC. It also features a CAN interface compliant with CAN 2.0 A&B specifications for both 11-bit and 29-bit formats, enabling high-speed reading of V/I/P parameters within 10ms.

USER-FRIENDLY INTERFACE

Chroma 62000D sports a next-generation GUI with an intuitive, smart-phone like touch panel. Using the icons on the touchscreen interface, the user can perform any voltage/current settings and measurements, program sequence control settings, preview output waveforms, and more.



Control interface

SPECIFICATIONS - 1 (100V & 600V Models)

Model	62060D-100	62120D-100	62180D-100	62060D-600	62120D-600	62180D-600
Source/Sink Ratings						
Source/Sink Voltage	0-100V			0-600V		
Source/Sink Current	± 180A	± 360A	± 540A	± 40A	± 80A	± 120A
Source/Sink Power *1	± 6000W	± 12000W	± 18000W	± 6000W	± 12000W	± 18000W
Min. Load Voltage (@ I Load Max.) *2	5V			30V		
Line Regulation						
Voltage	±0.01% F.S.					
Current	±0.05% F.S.					
Load Regulation						
Voltage	±0.02% F.S.					
Current	±0.1% F.S.					
Voltage Measurement*3						
Range	20V / 100V			120V / 600V		
Accuracy	0.05% + 0.05%F.S.					
Current Measurement*3						
Range	36A / 180A	72A / 360A	108A / 540A	8A / 40A	16A / 80A	24A / 120A
Accuracy	0.1% + 0.1%F.S.					
Output Noise & Ripple						
P-P (20MHz)	150 mV			420mV		
rms (Voltage)	25 mV			85mV		
rms (Current)	150mA	300mA	450mA	30mA	60mA	90mA
Programming Response Time						
Rise Time (Full Load)	10 ms			20ms		
Rise Time (No Load)	10 ms			10 ms		
Fall Time (Full Load)	10 ms			20ms		
Fall Time (No Load)	10 ms			10 ms		
Slew Rate Control						
Voltage slew rate range	0.001V/ms~ 10V/ms			0.001V/ms~60V/ms		
Current slew rate range	0.001A-10A/ms	0.001A-20A/ms	0.001A-30A/ms	0.001A-20A/ms	0.001A-40A/ms	0.001A-60A/ms
Minimum transition time (CV)	0.5ms			0.5ms		
Transient Response Time (CV)	Recovers within 500µs to ±0.75% of steady-state output for a 50% to 100% or 100% to 50% load change (1A/µs)					
Operating Mode						
Source	CC, CV, CP, Ri					
Load	CC, CR, CP					
Source & Load	CC, CV, CP, CR, Ri					
Efficiency (Typical)	Source > 0.91 Sink > 0.90	Source > 0.91 Sink > 0.90	Source > 0.92 Sink > 0.90	Source > 0.91 Sink > 0.92	Source > 0.92 Sink > 0.93	Source > 0.92 Sink > 0.93
Drift (30 minutes)						
Voltage	0.04% of Vmax			0.04% of Vmax		
Current	0.06% of Imax			0.06% of Imax		
Drift (8 hours)						
Voltage	0.02% of Vmax			0.02% of Vmax		
Current	0.04% of Imax			0.04% of Imax		
Temperature Coefficient						
Voltage	0.04% of Vmax/°C			0.04% of Vmax/°C		
Current	0.06% of Imax/°C			0.06% of Imax/°C		

Note *1: When input at low voltage 200Vac~220Vac, output power rate derates to 67%; when input at high voltage 380Vac~480Vac, output power is a full 100%. (Example: 18kW derates to 12kW at 200Vac~220Vac.)

Note *2: The specification of minimum load voltage is the same when operating under source & load mode.

Note *3: Source mode supports high and low scale measurement accuracy. For other modes, please refer to the manual for details.

SPECIFICATIONS - 1 (100V & 600V Models)

Model	62060D-100	62120D-100	62180D-100	62060D-600	62120D-600	62180D-600
Programming & Measurement Resolution						
Voltage (Front Panel)	10 mV			10 mV		
Current (Front Panel)	10 mA			10 mA		
Voltage (Digital Interface)	0.002% of Vmax			0.002% of Vmax		
Current (Digital Interface)	0.004% of Imax			0.002% of Imax		
Voltage (Analog Interface)	0.04% of Vmax			0.04% of Vmax		
Current (Analog Interface)	0.04% of Imax			0.04% of Imax		
Programming Accuracy						
Voltage (Front Panel and Digital Interface)	0.05% of Vmax			0.05% of Vmax		
Current (Front Panel and Digital Interface)	0.2% of Imax			0.2% of Imax		
Power (Front Panel and Digital Interface)	0.3% of Pmax			0.3% of Pmax		
Voltage (Analog Interface)	0.2% of Vmax			0.2% of Vmax		
Current (Analog Interface)	0.3% of Imax			0.3% of Imax		
APG Measurement Accuracy						
Voltage (Analog Interface)	0.5% of Vmax			0.5% of Vmax		
Current (Analog Interface)	0.75% of Imax			0.75% of Imax		
Analog Interface (I/O)						
Voltage and Current Programming Inputs (I/P)	Voltage : 0~10 Vdc of F.S. Current : Source I : 0~10 Vdc of F.S. Load I : 0~10 Vdc of F.S.					
Voltage and Current Monitor Output (O/P)	Voltage : 0~10 Vdc of F.S. Current : -10~10 Vdc of F.S.					
External ON/OFF (I/P)	TTL: Active Low or High (selective)					
DC_ON Signal (O/P)	Level by user defined (Time delay=1ms at voltage slew rate of 10V/ms.)					
CV or CC Mode Indicator (O/P)	TTL Level High=CV mode ; TTL Level Low=CC mode					
OTP Indicator (O/P)	TTL: Active Low					
System Fault Indicator (O/P)	TTL: Active Low					
Safety Interlock (I/P)	Time accuracy: <100ms					
Remote Inhibit (I/P)	TTL: Active Low					
OVP Adjustment Range						
Range	0-110% programmable					
Accuracy	± 1% of full scale output					
Auto Sequencing (List Mode)						
Number of Program	10					
Number of Sequence	100					
Dwell time Range	2ms-15,000s					
Trig. Source	Manual / Auto / External					
Auto Sequencing (Step Mode)						
Start Voltage	0 to full scale					
End Voltage	0 to full scale					
Run Time	hh : mm : ss.sss (00 : 00 : 00.001 to 99 : 59 : 59.99)					
Trig. Source	Auto					
Series & Parallel Operation by Master / Slave Control *4	Series: 2 units Parallel: 3 units	Series: 2 units Parallel: 3 units	Series: 2 units Parallel: 10 units	Series: 2 units Parallel: 3 units	Series: 2 units Parallel: 3 units	Series: 2 units Parallel: 10 units
Input Specification						
AC Input Voltage 3-phase, 3-wire + Ground (w/o neutral)	3 Φ 200Vac~220Vac \pm 10% w/o neutral 3 Φ 380Vac~480Vac \pm 10% w/o neutral (67% output power@200~220Vac input, 100% output power@380~480Vac input)					
AC Frequency Range	47~63 Hz					
Power Factor	>0.97					
General Specification						
Maximum Remote Sense Line Drop Compensation	2% of full scale voltage per line (5% total)			2% of full scale voltage per line (4% total)		
Operating Temperature Range	0°C~40°C					
Storage Temperature Range	-25°C~70°C					
Dimension Size (HxWxD) mm	133 x 428 x 730 mm / 5.23 x 16.85 x 28.74 inch					
Weight (kg)	32.6 kg/71.9 lbs	38.8 kg/85.5 lbs	45 kg/100 lbs	30.6 kg/67.4 lbs	34.8 kg/76.7 lbs	39 kg/86.1 lbs

Note *4: For higher power >180kW~540kW, please call for availability.

* All specifications are subject to change without notice.

SPECIFICATIONS - 2 (1200V & 1800V Models)

Model	62120D-1200	62180D-1200	62180D-1800
Source/Sink Ratings			
Source/Sink Voltage	0~1200V	0~1200V	0~1800V
Source/Sink Current	±40A / ±55A *4	±40A / ±55A *4	±40A / ±55A *4
Source/Sink Power *1	±12000W / ±13000W *5	±18000W / ±19500W *5	±18000W / ±19500W *5
Min. Load Voltage (@ I Load Max.) *2	90V		
Line Regulation			
Voltage	±0.01% F.S.		
Current	±0.05% F.S.		
Load Regulation			
Voltage	±0.04% F.S.		
Current	±0.1% F.S.		
Voltage Measurement*3			
Range	240V /1200V	240V /1200V	360V / 1800V
Accuracy	0.05% + 0.05%F.S.	0.05% + 0.075%F.S.	0.05% + 0.05%F.S.
Current Measurement*3			
Range	8A / 40A / 55A *4	8A / 40A / 55A *4	8A / 40A / 55A *4
Accuracy	0.1% + 0.1%F.S.		
Output Noise & Ripple			
P-P (20MHz)	840mV	1260mV	1260mV
rms (Voltage)	170mV	255mV	255mV
rms (Current)	30mA	30mA	30mA
Programming Response Time			
Rise Time (Full Load)	20ms		
Rise Time (No Load)	10 ms		
Fall Time (Full Load)	20ms		
Fall Time (No Load)	10ms		
Slew Rate Control			
Voltage slew rate range	0.001V/ms~120V/ms	0.001V/ms~180V/ms	0.001V/ms~180V/ms
Current slew rate range	0.001A~20A/ms		
Minimum transition time (CV)	0.5ms		
Transient Response Time (CV)	Recovers within 500µs to ±0.75% of steady-state output for a 50% to 100% or 100% to 50% load change (1A/µs)		
Operating Mode			
Source	CC, CV, CP, Ri		
Load	CC, CR, CP		
Source & Load	CC, CV, CP, CR, Ri		
Efficiency (Typical)	Source > 0.91 Sink > 0.92	Source > 0.91 Sink > 0.90	Source > 0.92 Sink > 0.93
Drift (30 minutes)			
Voltage	0.04% of Vmax	0.06% of Vmax	0.04% of Vmax
Current	0.06% of Imax		
Drift (8 hours)			
Voltage	0.02% of Vmax	0.03% of Vmax	0.02% of Vmax
Current	0.04% of Imax		
Temperature Coefficient			
Voltage	0.04% of Vmax/°C	0.06% of Vmax/°C	0.04% of Vmax/°C
Current	0.06% of Imax/°C		

Note *1: When input at low voltage 200Vac~220Vac, output power rate derates to 67%; when input at high voltage 380Vac~480Vac, output power is a full 100%. (Example: 18kW derates to 12kW at 200Vac~220Vac.)

Note *2: The specification of minimum load voltage is the same when operating under source & load mode.

Note *3: Source mode supports high and low scale measurement accuracy. For other modes, please refer to the manual for details.

Note *4: 62120D-1200 can operate continuously at full power, with a current and ambient temperature of 50A at 40°C and 55A at 35°C.

62180D-1200 & 62180D-1800 can operate continuously at full power, with a current and ambient temperature of 40A at 40°C, 50A at 35°C and 55A at 30°C (< 5 minutes at 35°C).

Note *5: 62120D-1200 can operate continuously up to 13kW/55A at an ambient temperature of 35°C. 62180D-1200 & 62180D-1800 can operate continuously up to 19.5kW/50A at an ambient temperature of 35°C.

SPECIFICATIONS - 2 (1200V & 1800V Models)

Model	62120D-1200	62180D-1200	62180D-1800
Programming & Measurement Resolution			
Voltage (Front Panel)	100 mV	100 mV	100 mV
Current (Front Panel)	10 mA	10 mA	10 mA
Voltage (Digital Interface)	0.002% of Vmax	0.003% of Vmax	0.002% of Vmax
Current (Digital Interface)		0.004% of Imax	
Voltage (Analog Interface)	0.04% of Vmax	0.06% of Vmax	0.04% of Vmax
Current (Analog Interface)		0.04% of Imax	
Programming Accuracy			
Voltage (Front Panel and Digital Interface)	0.05% of Vmax	0.075% of Vmax	0.05% of Vmax
Current (Front Panel and Digital Interface)		0.2% of Imax	
Power (Front Panel and Digital Interface)		0.3% of Pmax	
Voltage (Analog Interface)		0.2% of Vmax	
Current (Analog Interface)		0.3% of Imax	
APG Measure Accuracy			
Voltage (Analog Interface)		0.5% of Vmax	
Current (Analog Interface)		0.75% of Imax	
Analog Interface (I/O)			
Voltage and Current Programming Inputs (I/P)	Voltage : 0~10 Vdc of F.S. Current : Source I : 0~10 Vdc of F.S. Load I : 0~10 Vdc of F.S.		
Voltage and Current Monitor Output (O/P)	Voltage : 0~10 Vdc of F.S. Current : -10~10 Vdc of F.S.		
External ON/OFF (I/P)	TTL: Active Low or High (selective)		
DC_ON Signal (O/P)	Level by user defined (Time delay=1ms at voltage slew rate of 10V/ms.)		
CV or CC Mode Indicator (O/P)	TTL Level High=CV mode ; TTL Level Low=CC mode		
OTP Indicator (O/P)	TTL: Active Low		
System Fault Indicator (O/P)	TTL: Active Low		
Safety Interlock (I/P)	Time accuracy: <100ms		
Remote Inhibit (I/P)	TTL: Active Low		
OVP Adjustment Range			
Range	0~110% programmable		
Accuracy	±1% of full scale output		
Auto Sequencing (List Mode)			
Number of Program	10		
Number of Sequence	100		
Dwell time Range	2ms~15,000s		
Trig. Source	Manual / Auto / External		
Auto Sequencing (Step Mode)			
Start Voltage	0 to full scale		
End Voltage	0 to full scale		
Run Time	hh : mm : ss.sss (00 : 00 : 00.001 to 99 : 59 : 59.99)		
Trig. Source	Auto		
Series & Parallel Operation *6	Master / slave control for 3 units (Parallel: 3 units)	Master/slave control for 30 units (Parallel: 30 units)	
Input Specification			
AC Input Voltage 3 phase, 3 Wire + Ground (w/o neutral)	3 Φ 200Vac~220Vac \pm 10% w/o neutral 3 Φ 380Vac~480Vac \pm 10% w/o neutral (67% output power@200~220Vac input, 100% output power@380~480Vac input)		
AC Frequency Range	47~63 Hz		
Power Factor	>0.97		
General Specification			
Maximum Remote Sense Line Drop Compensation	2% of full scale voltage per line (4% total)		
Operating Temperature Range	0°C~40°C		
Storage Temperature Range	-25°C~70°C		
Dimension Size (HxWxD) mm	133 x 428 x 730 mm / 5.23 x 16.85 x 28.74 inch		
Weight (kg)	34.8 kg/76.7 lbs	39 kg/86.1 lbs	39 kg/86.1 lbs

Note *6: For higher power >180kW~540kW, please call for availability.

* All specifications are subject to change without notice.

SPECIFICATIONS - 3 (2000V Models)

Model	62360D-2000HL	62450D-2000HL
Source/Sink Ratings		
Source/Sink Voltage	650V / 2000V	650V / 2000V
Source/Sink Current	± 180A / ± 60A (650V / 2000V)	± 180A / ± 60A (650V / 2000V)
Source/Sink Power	± 36000W	± 45000W
Min. Load Voltage (@ I Load Max.) *1	35V / 105V	35V / 105V
Line Regulation		
Voltage	± 0.01% F.S.	
Current	± 0.05% F.S.	
Load Regulation		
Voltage	± 0.04% F.S.	
Current	± 0.1% F.S.	
Voltage Measurement		
Range	650V / 2000V	650V / 2000V
Accuracy	0.02% + 0.02%F.S.	0.02% + 0.02%F.S.
Current Measurement		
Range	180A / 60A	180A / 60A
Accuracy	0.04% + 0.04%F.S.	0.04% + 0.04%F.S.
Output Noise & Ripple		
P-P (20MHz)	850mV / 3500mV	850mV / 3500mV
rms (Voltage)	80mV / 240mV	80mV / 240mV
rms (Current)	135mA / 75mA	135mA / 75mA
Programming Response Time		
Rise Time (Full Load)	20 ms	20 ms
Rise Time (No Load)	10 ms	10 ms
Fall Time (Full Load)	20 ms	20 ms
Fall Time (No Load)	10 ms	10 ms
Slew Rate Control		
Voltage slew rate range	0.0001V/ms - 65V/ms / 0.0001V/ms - 200V / ms	0.0001V/ms - 65V/ms / 0.0001V/ms - 200V / ms
Current slew rate range	0.0001A - 90A/ms / 0.0001A - 30A/ms	0.0001A - 90A/ms / 0.0001A - 30A/ms
Minimum transition time (CV)	0.5ms	0.5ms
Transient Response Time (CV)	Recovers within 500 μ s to ± 0.5%F.S. of output for a 50% to 100% or 100% to 50% load change (1A/ μ s)	
Operating Mode		
Source	CC, CV, CP, Ri	
Load	CC, CR, CP	
Source & Load	CC, CV, CP, CR, Ri	
Efficiency (Typical)	Source > 93.6% ; Sink > 93.6%	Source > 94.3% ; Sink > 94%
Drift (30 minutes)		
Voltage	0.04% of Vmax	0.04% of Vmax
Current	0.06% of Imax	0.06% of Imax
Drift (8 hours)		
Voltage	0.02% of Vmax	0.02% of Vmax
Current	0.04% of Imax	0.04% of Imax
Temperature Coefficient		
Voltage	0.04% of Vmax/°C	0.04% of Vmax/°C
Current	0.06% of Imax/°C	0.06% of Imax/°C

Note *1: The specification of minimum load voltage is the same when operating under source & load mode.

SPECIFICATIONS - 3 (2000V Models)

Model	62360D-2000HL	62450D-2000HL
Programming & Measurement Resolution		
Voltage (Front Panel)	100 mV	100 mV
Current (Front Panel)	10 mA	10 mA
Voltage (Digital Interface)	0.002% of Vmax	0.002% of Vmax
Current (Digital Interface)	0.004% of Vmax	0.004% of Vmax
Voltage (Analog Interface)	0.04% of Vmax	0.06% of Vmax
Current (Analog Interface)	0.04% of Vmax	0.04% of Vmax
Programming Accuracy		
Voltage (Front Panel and Digital Interface)	0.05% of Vmax	0.05% of Vmax
Current (Front Panel and Digital Interface)	0.2% of Imax	0.2% of Imax
Power (Front Panel and Digital Interface)	0.3% of Pmax	0.3% of Pmax
Voltage (Analog Interface)	0.2% of Vmax	0.2% of Vmax
Current (Analog Interface)	0.3% of Imax	0.3% of Imax
APG Measure Accuracy		
Voltage (Analog Interface)	0.5% of Vmax	0.5% of Vmax
Current (Analog Interface)	0.75% of Imax	0.75% of Imax
Analog Interface (I/O)		
Voltage and Current Programming Inputs (I/P)	Voltage: 0~10 Vdc of F.S. Current : Source I: 0~10 Vdc of F.S. Load I: 0~10 Vdc of F.S.	
Voltage and Current Monitor Output (O/P)	Voltage: 0~10 Vdc of F.S. Current: -10~10 Vdc of F.S.	
External ON/OFF (I/P)	TTL: Active Low or High (selective)	
DC_ON Signal (O/P)	Level by user defined (Time delay=1ms at voltage slew rate of 10V/ms.)	
CV or CC Mode Indicator (O/P)	TTL Level High=CV mode ; TTL Level Low=CC mode	
OTP Indicator (O/P)	TTL: Active Low	
System Fault Indicator (O/P)	TTL: Active Low	
Safety Interlock (I/P)	Time accuracy: <100ms	
Remote Inhibit (I/P)	TTL: Active Low	
OVP Adjustment Range		
Range	0~110% programmable	
Accuracy	± 1% of full scale output	
Auto Sequencing (List Mode)		
Number of Program	10	
Number of Sequence	100	
Dwell time Range	2ms~15,000s	
Trig. Source	Manual / Auto / External	
Auto Sequencing (Step Mode)		
Start Voltage	0 to full scale	
End Voltage	0 to full scale	
Run Time	hh : mm : ss.sss (00 : 00 : 00.001 to 99 : 59 : 59.99)	
Trig. Source	Auto	
Parallel Operation *2	Master / slave control for 2 units	
Input Specification		
AC Input Voltage 3 phase, 3 Wire + Ground (w/o neutral)	3Φ 380Vac~480Vac± 10% w/o neutral	
AC Frequency Range	47~63 Hz	
Power Factor	>0.99	
General Specification		
Maximum Remote Sense Line Drop Compensation	2% of full scale voltage per line (4% total)	2% of full scale voltage per line (4% total)
Operating Temperature Range	0°C~40°C	
Storage Temperature Range	-25°C~70°C	
Dimension Size (HxWxD) mm	177 x 428 x 898.5 mm / 5.23 x 16.85 x 35.26 inch	
Weight (kg)	72 kg / 159 lbs	72 kg / 159 lbs

Note *2: For higher power >90kW-1.35MW, please call for availability.

* All specifications are subject to change without notice.

SOFTPANEL

The 62000D series can be operated from the front panel controls or from available softpanel. This user friendly software includes all functions of the 62000D series and is easy to understand and operate. The 62000D can be controlled via GPIB, USB and Ethernet interfaces for remote control and automated testing applications.



List Mode



Fixed Mode



Step Mode

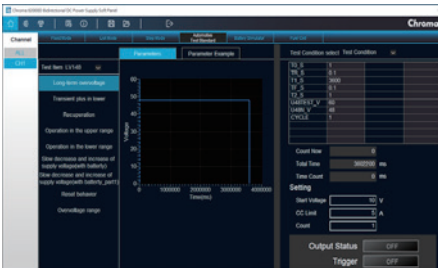

Automotive Test Standard

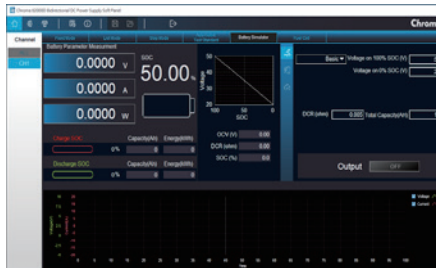

Battery Simulator



Fuel Cell

PANEL DESCRIPTION

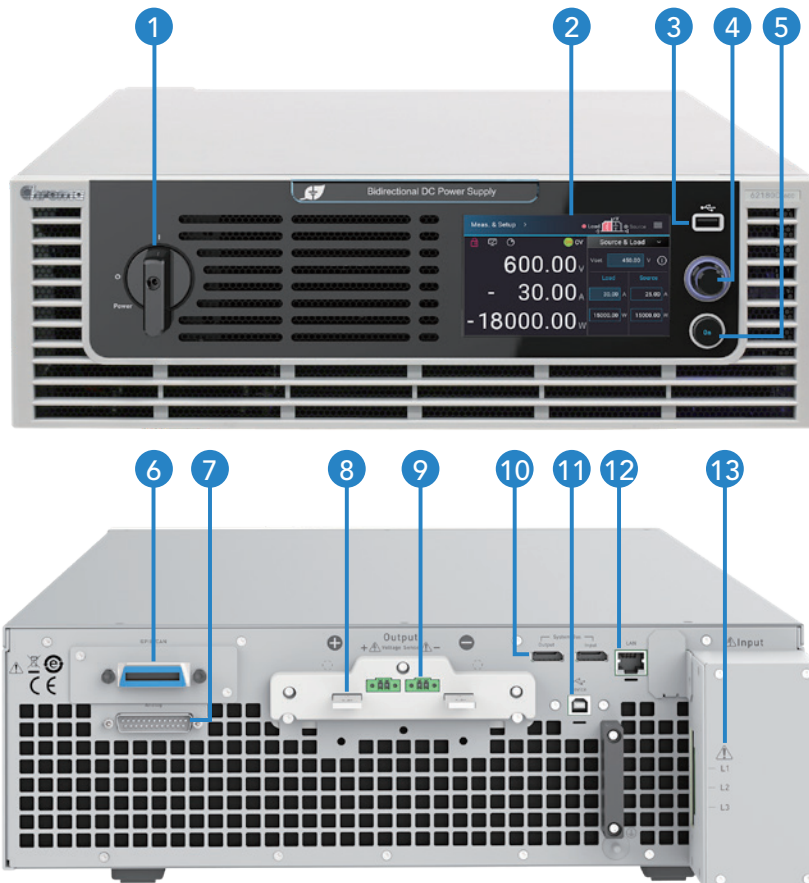

100V/600V/1200V/1800V models

1. **POWER Switch**
2. **TFT Control Interface**
Displays: measurements, setup, control, and status
3. **USB HOST** (not yet supported)
Programming: program fetching, data downloading, firmware updates, etc.
4. **Pushable Rotary Switch**
Rotate to edit screen and set values; after configuration, push to confirm input
5. **OUTPUT ON Key**
Press the ON key: light indicates Output ON, dark indicates Output OFF
6. **GPIB & CAN Interfaces Shared Slot** (choose one)
7. **Analog Programming Interface**
For analog level to program and monitor output voltage & current
8. **DC Output Terminal**
9. **Remote Sense Terminal**
10. **Current Sharing Terminal**
Connect the cable to slave unit
11. **USB Interface** (standard)
12. **LAN Interface** (standard)
13. **AC Input Terminal**

PANEL DESCRIPTION

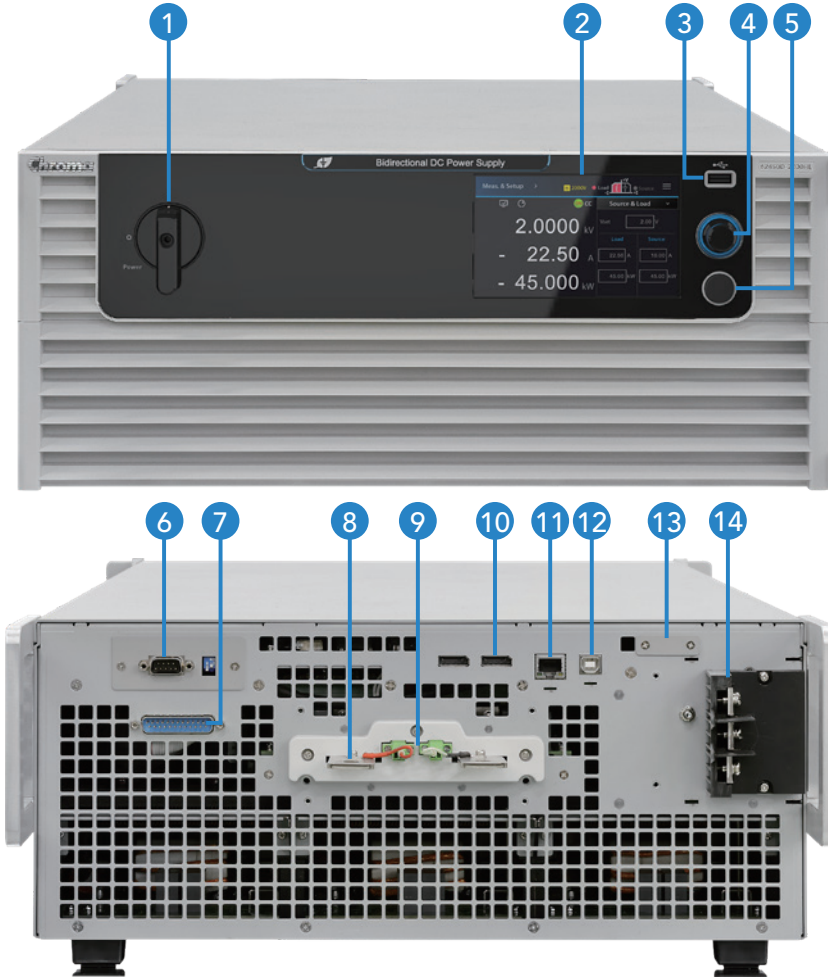

2000HL models

1. **POWER Switch**
2. **TFT Control Interface**
Displays: measurements, setup, control, and status
3. **USB HOST** (not yet supported)
Programming: program fetching, data downloading, firmware updates, etc.
4. **Pushable Rotary Switch**
Rotate to edit screen and set values; after configuration, push to confirm input
5. **OUTPUT ON Key**
Press the ON key: light indicates Output ON, dark indicates Output OFF
6. **GPIB & CAN Interfaces Shared Slot** (choose one)
7. **Analog Programming Interface**
For analog level to program and monitor output voltage & current
8. **DC Output Terminal**
9. **Remote Sense Terminal**
10. **Current Sharing Terminal**
11. **LAN Interface** (standard)
12. **USB Interface** (standard)
13. **Aurora Interface** (option) (reserved)
14. **AC Input Terminal**

ORDERING INFORMATION

62000D 系列: Programmable Bidirectional DC Power Supply
 62060D-100: Programmable Bidirectional DC Power Supply 100V/180A/6kW
 62120D-100: Programmable Bidirectional DC Power Supply 100V/360A/12kW
 62180D-100: Programmable Bidirectional DC Power Supply 100V/540A/18kW
 62060D-600: Programmable Bidirectional DC Power Supply 600V/40A/6kW
 62120D-600: Programmable Bidirectional DC Power Supply 600V/80A/12kW
 62180D-600: Programmable Bidirectional DC Power Supply 600V/120A/18kW
 62120D-1200: Programmable Bidirectional DC Power Supply 1200V/40A/12kW
 62180D-1200: Programmable Bidirectional DC Power Supply 1200V/40A/18kW
 62180D-1800: Programmable Bidirectional DC Power Supply 1800V/40A/18kW
 62360D-2000HL: Programmable Bidirectional DC Power Supply 2000V/180A/36kW
 62450D-2000HL: Programmable Bidirectional DC Power Supply 2000V/180A/45kW

A620039 : GPIB Interface (Supports 62xxxD-100/600/1200/1800 models)
 A620045 : CAN Interface (Supports 62xxxD-100/600/1200/1800 models)
 A620046 : 62000D Softpanel
 B620003: Optional Solar Array Simulation Function (Supports 62XXXD-600/1200/1800/2000HL models)
 A636011: GPIB Interface (Supports 62XXXD-2000HL models)
 A636012: CAN FD Interface (Supports 62XXXD-2000HL models)

* Models with HL indicate dual output range functionality

Get more product & global distributor information in Chroma ATE APP



HEADQUARTERS
 CHROMA ATE INC.
 88 Wenmao Rd.,
 Guishan Dist.,
 Taoyuan City
 333001, Taiwan
 T +886-3-327-9999
 F +886-3-327-8898
 www.chromaate.com
 info@chromaate.com

U.S.A.
 CHROMA SYSTEMS
 SOLUTIONS, INC.
 19772 Pauling,
 Foothill Ranch,
 CA 92610, USA
 T +1-949-600-6400
 F +1-949-600-6401
 www.chromausa.com
 sales@chromausa.com

EUROPE
 CHROMA ATE EUROPE B.V.
 Morsestraat 32, 6716 AH
 Ede, The Netherlands
 T +31-318-648282
 F +31-318-648288
 www.chromaeu.com
 salesnl@chromaeu.com

CHROMA GERMANY GMBH
 Südtiroler Str. 9, 86165,
 Augsburg, Germany
 T +49-821-790967-0
 F +49-821-790967-600
 www.chromaeu.com
 salesde@chromaeu.com

JAPAN
 CHROMA JAPAN
 CORP.
 888 Nippa-cho,
 Kouhoku-ku,
 Yokohama-shi,
 Kanagawa,
 223-0057 Japan
 T +81-45-542-1118
 F +81-45-542-1080
 www.chroma.co.jp
 info@chroma.co.jp

KOREA
 CHROMA ATE
 KOREA BRANCH
 312, Gold Tower,
 14-2, Pangyoyeok-ro
 192, Bundang-gu,
 Seongnam-si,
 Gyeonggi-do,
 13524, Korea
 T +82-31-781-1025
 F +82-31-8017-6614
 www.chromaate.co.kr
 info@chromaate.com

CHINA
 CHROMA ELECTRONICS
 (SHENZHEN) CO., LTD.
 8F, No.4, Nanyou Tian
 An Industrial Estate,
 Shenzhen, China
 T +86-755-2664-4598
 www.chroma.com.cn
 info@chromaate.com

SOUTHEAST ASIA
 QUANTEL PTE LTD.
 (A company of Chroma Group)
 25 Kallang Avenue #05-02
 Singapore 339416
 T +65-6745-3200
 F +65-6745-9764
 www.quantel-global.com
 sales@quantel-global.com