

Programmable laboratory power supplies direct from the manufacturer

ET SYSTEM® is the perfect partner for
standard solutions, system integrations and customer specific requirements

Industry 4.0 compatible



DC Sources

750 W – 1,4 MW, voltages up to 1,500 V (2,000 V) /
currents up to 50,000 A

DC Sources with Integrated Load for 2-Quadrant Operation

1,2 kW – 10 kW, voltages up to 600 V / currents up to 500 A

Bidirectional DC Source/Sink with Grid Power Recycling

7 kW – 2 MW (master/slave)

AC Sources

250 VA – 2 MVA and 700 VAC/1,000 VDC,
2,000 A per phase, 1 or 3-phase

Bidirectional AC Source/Sink with Grid Power Recycling

30 kVA – 500 kVA (master/slave)

Electronic Loads

150 W – 200 kW



Imagefilm

MADE 
IN 
GERMANY 



Video

DC SOURCES

TECHNICAL DATA

- 3 kW to 1,4 MW
- Output voltage up to 1,500 V (2,000 V)
- Output current up to 50,000 A
- Standard input voltages DC&AC also according to customer requirements
- 21 kW in 3 U

FEATURES

The LAB/HP series has the following features, further features can be found in detail in the datasheet

- Generation of any voltage and current curves via USB stick or digital interface (sequential control)

- Data log function: Current operating values are stored on a USB stick at an adjustable interval.
- Available digital interfaces IEEE488, RS485, RS232, LAN and USB
- ATI 5/10 analog interface galvanically isolated: 0V to 5V or 0V to 10V (user selectable) and soft interlock
- Adjustable filter function for the analog interface
- Available modes: UI, UIR, UIP and PVSIm
- Adjustable voltage and current rise time (U- and I-Slope)
- Umax and Imax adjustable by the user to limit output voltage or current
- Adjustable switch-off time for the device after pressing the start button
- Storable U / I output characteristic (e.g. for PVsim, shading) on USB stick
- "High Speed" rise and fall time of the DC output voltage is reduced by a factor of 10 on average compared to standard times
- Modular design for increased performance: Master-Slave operation up to 504 kW

- Temperature controlled fan
- Display via TFT touch display (values, status display and mode selection)
- Via function USB stick Function generator with different curves
- auto ranging function
- Controllable via WLAN
- Support SCPI command language
- Protective functions: OVP, OCP, UVP (adjustable time)
- LabView driver available
- Control software for Windows
- External sense outputs
- Fast crossover between CV & CC
- Modifiable according to customer requirements, outputs up to 1,4 MW possible

APPLICATIONS

- Independent stand-alone test station realizable via script control in connection with the data log function
- Manual testing of varistors
- Simulation of solar modules simulate
- Testing of photovoltaic components e.g. inverters or battery charge controllers
- Simulation and investigation of engine starting gears (car starting curve)
- Testing of automotive electronics and aircraft applications
- Charging of fuel cells
- Energy storage technology
- Testing of semiconductors
- Testing DC/DC converters



LAB/HP

3 kW – 1,4 MW
 Voltages up to 1,500 V (2,000 V)
 Currents up to 50,000 A
 19" x 2-9 U x 440-620 mm



Video

MORE DC SOURCES



LAB/SMP

750 W – 2,4 kW
Voltages up to 1,200 V
Currents up to 160 A
From 19" x 1 U x 440 mm



LAB/SMP/E

750 W – 2,4 kW
Voltages up to 1,200 V
Currents up to 160 A
From 19" x 1 U x 440 mm

DC SOURCES OPERATING SOFTWARE



The Lab View programmed software can control all devices of the LAB/HP and LAB/SMP series via all existing interfaces. The operating software has been designed to allow full remote control of the devices. It not only allows all operating modes and settings to be set from the computer, it also allows complete test sequences to be created on the computer and transferred to any device - via the Internet even around the globe.

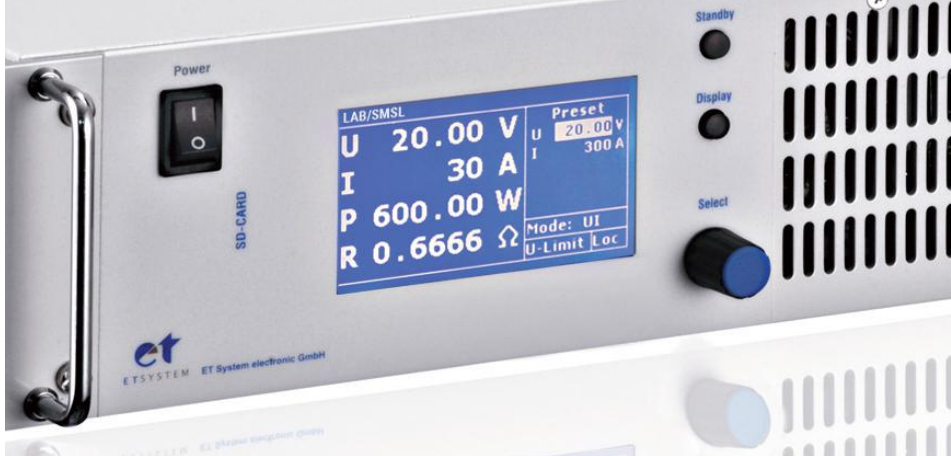

DC SOURCES WITH INTEGRATED LOAD

- From 1,2 kW to 10 kW
- Output voltages up to 600 V
- Output currents up to 500 A
- Compact design
- Quiet operation, ensuring that it is pleasant to work within the vicinity of the unit
- Very easy to control via front panel
- Information via graphic display
- Constant voltage, current, resistance, power operation and simulation of PV arrays
- With integrated load; 300 – 2,000 W voltage-controlled for 2-quadrant operation
- Create any type of voltage or current curve via memory card or digital interface (sequential operation)
- Script operation, in conjunction with the Datalog function, enables an independent stand-alone test field to be set up
- Standard integrated ATI 5/10 galvanically isolated analogue interface: 0 – 5 V or 0 – 10 V (user selectable) and RS232, soft interlock
- Digital interfaces IEEE488, RS485, USB and LAN (optional)
- SD card slot (optional)
- Filter functions which can be adjusted for analogue interface
- Voltage rise time and current rise time (U and I slopes) are adjustable

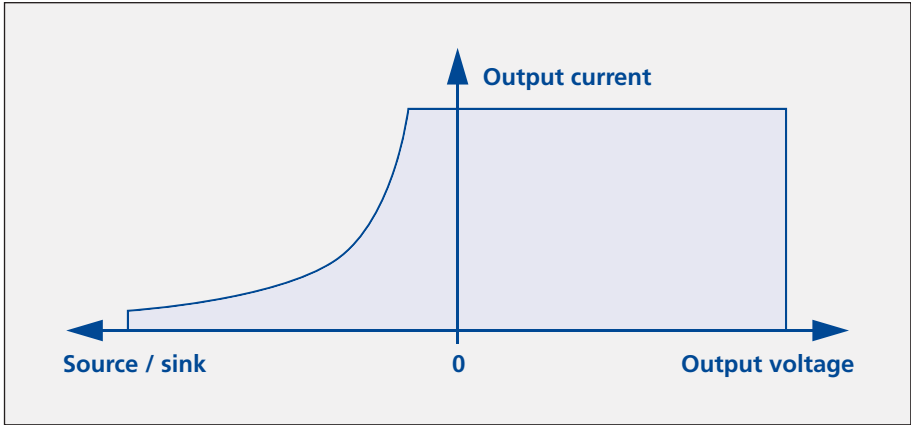

- U_{\max} and I_{\max} can be set by the user in order to limit output voltage or output current
- A switch-off time can be set for the unit once the start button has been pressed
- Create U/I output characteristics which can be saved (e.g. for PV-Sim, shading)
- Datalog function: Current operating values are saved to the memory card at adjustable time intervals
- Protective functions for OVP, OTP, UVP, OCP
- Special versions available on request



LAB/HPL

1,2 kW – 10 kW
 Voltages up to 600 V
 Currents up to 500 A
 From 19" x 3 U x 620 mm



BIDIRECTIONAL DC SOURCES WITH GRID POWER RECYCLING

TECHNICAL DATA

- Power from 7 kW to 1,4 MW
- Output current up to 50,000 A
- Output voltage up to 1,500 V
- Power ranges 7 kW to 504 kW available for each nominal output voltage
- Constant voltage (0 to 100%), constant current (0 to 100%), constant power operation (5 to 100%)

FEATURES

The LAB/HPR series has the following features, more details can be found in the data sheet

- Fully digital control and regulation
- Power increase through master-slave connection for users up to 504kW
- Power up to 1,4 MW possible through system integration
- Control via 5" color TFT touch display (values, status display and mode selection)
- Measuring range switchover for current and voltage
- Adjustable voltage and current rise time (U- and I-Slope)
- Protective functions: OVP, OCP, UVP (adjustable time)
- Front USB stick connector (optional)
- Current operating values can be stored on USB stick at adjustable intervals
- Via function USB stick Function generator with different curves
- Fast crossover between CV & CC
- auto ranging function
- Software for battery simulation (optional)
- Power recovery with 95% recovery
- External sense outputs
- Adjustable switch-off time for the device after pressing the start button
- Simulation of the internal resistance

- Temperature controlled fan
- Support SCPI command language
- LabView driver available
- Control software for Windows

APPLICATIONS

- Testing the functionality of battery, fuel cells and photovoltaic modules can be simulated Battery simulation
- DC load for fuel cells
- Charging and discharging of fuel cells
- Power conversion tests (charging and discharging equipment)
- Charging and discharging batteries (battery tests)
- Adjustment of car starting curve
- Testing of power components in electric vehicles
- DC sources/countersinks for test benches with low voltage/high voltage
- Testing the inverter
- Power supply system



LAB/HPR

7 kW – 1,4 MW
 Voltages up to 1,500 V
 Currents up to 200 A
 19" x 3 U x 670 mm

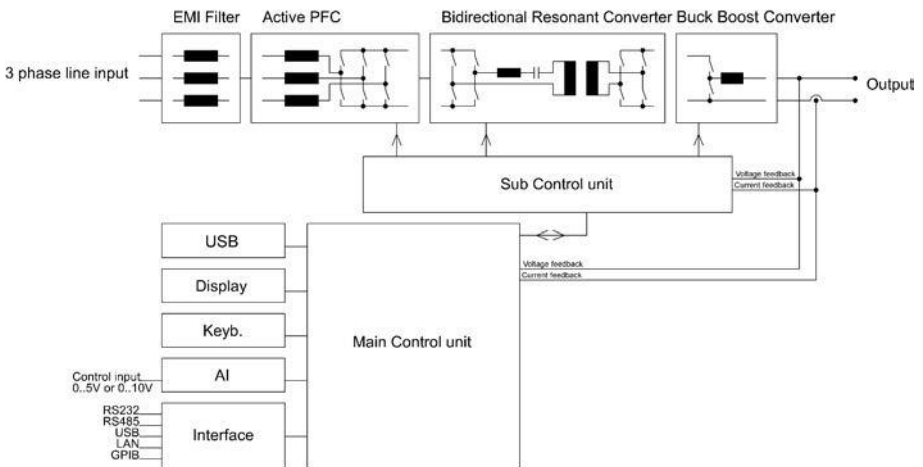

BIDIRECTIONAL DC SOURCES WITH GRID POWER RECYCLING

- From 30 kW to 2 MW
- Voltages of 5-300 V / 5-600 V / 5-1,200 V
- Maximum currents in a single system $\pm 1,500$ A
- Available as multi-channel output (e.g. 2-channel DC output)
- Continuous transition from charging to discharging
- Modular system, systems can be connected in parallel
- Galvanically isolated from the grid
- TFT touch display with simple menu navigation
- Emergency off in the front door
- Indicator lights for operating status
- Fan-cooling
- Fast response time < 1.5 ms (optional < 3 ms)
- Low grid feedback effect
- Sens Connection for compensating voltage drops on the DC line
- Programmable sequences that can be stored and reloaded
- 3 operating modes: constant voltage (CV), constant current (CC+ & CC-), constant power (CP+ & CP-) for charging and discharging
- The systems' "hardware limits" can be set specifically for the application
- Standard interfaces: LAN and RS485 (CAN optional)
- Special versions available on request

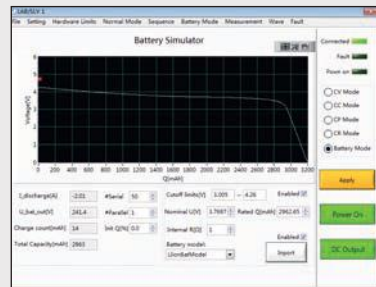
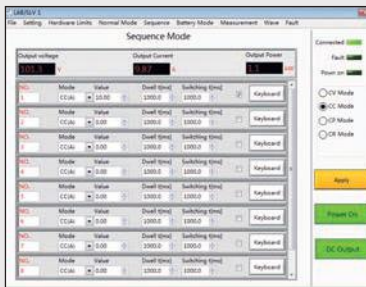



Video

LAB/SLV1

From 30 kW – 2 MW
 Voltages up to 2,000 V
 Maximum currents of $\pm 1,500$ A
 in single system
 Regulation time < 8 ms

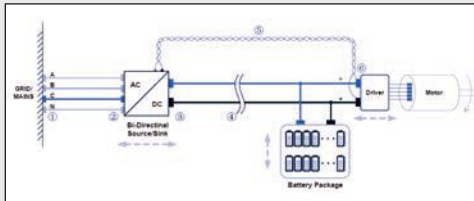

Test of the performance of the motor and motor's energy recovery system. DC source/sink for simulating storage batteries or energy storage systems.

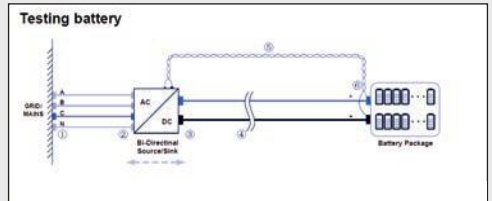

The device can be used as a charging or discharging device for batteries, in order to test their performance. It features an output contactor for disconnection under load.



AC SOURCES

TECHNICAL DATA

- Power from 250 VA to 12 kVA
- Output voltage up to 700 VAC / 1,000 VDC
- Output current up to 2,000 A
- Output frequency up to 2,000 Hz
- Indication via graphic display
- Linear regulated power amplifier, distortion factor at Pmax: 0.15%

FEATURES

The EAC-SP series has the following features, more details can be found in the datasheet

- Generation of any voltage and current curves via SD card or digital interface (sequential control)
- Data log function: Current measured values are stored on an SD card at an adjustable interval.
- Measurements of voltage (RMS, average value, peak value, crest factor), current (RMS, average value, peak current, crest factor) Active power, reactive power, apparent power, power factor
- Specification of frequency and phase angle
- Voltage constant - Current limited
- Storage locations for freely programmable waveforms (WAV files), can be imported via an external SD card (option)
- External oscillator input +/- 10V with adjustable delay up to 70 ms (option)
- Script control: Programming of sequences stored on the memory card
- Three non-volatile curves (programming via memory card)



- The script control in connection with the data log function enables the setup of an independent "stand-alone" test station
- Sync input for synchronizing with external sources (option)
- Sync output for triggering external measuring devices or similar (option)
- Output voltage can be switched off for a certain number of half periods (option)
- Output voltage can be switched on for a certain time (option)
- Available digital interfaces IEEE488, RS485, RS232, LAN and USB
- ATI 5/10 analog interface galvanically isolated: 0V bis 5V or 0 bis 10V
- Compact dimensions and low weight
- Special versions available on request

APPLICATIONS

- Simulation of worldwide voltage networks (1 - phase)
- Simulation of aeronautical, space, railway and maritime voltage networks
- AC power supply for use in laboratories and test fields for electrical components
- Testing of medical specific waveforms according to EN 60601.
- Independent stand-alone test station realizable via the script control in connection with the data log function

EAC/S 1 PHASE

250 VA – 12,000 VA
 Voltages up to 0 – 700 VAC / 1,000 VDC
 Currents up to 2,000 A
 From 19" x 3 U x 620 mm



EAC/3S 3 PHASE

750 VA – 36,000 VA
 Voltages up to 0 – 700 VAC / 1,000 VDC
 Currents up to 2,000 A per phase
 From 3 x 19" x 3 U x 620 mm





PROGRAMMABLE AC LABORATORY POWER SUPPLIES CURRENT-REGULATED

OVERVIEW

- Current and Voltage rating will be configured based on customer actual requirement
- Power range from 250 VA to 36 kVA
- 1 VAC to 300 VAC output voltages
- Maximum currents up to 2,000 A per phase
- Variable frequencies ranging from 45 Hz bis 70 Hz, 400 Hz (sine)
- Information via graphic display
- Measurement of: voltage, effective current, average and peak current, effective power, idle power, apparent power, power factor, crest factor
- Constant current operating mode
- 10 memory spaces to store current configurations
- External oscillator input ± 10 V (sine) with adjustable time delay of up to 70ms
- Script control: process programming and booting from memory card
- Datalog function: current operation values can be saved to a memory card at adjustable time intervals
- Script operation, in combination with the Datalog function, enables an independent stand-alone test field to be set up
- Digital interfaces IEEE, RS232, RS485, USB, LAN (optional)
- Galvanically isolated 0 V to 5 V or 0 V to 10 V analogue interface (optional)

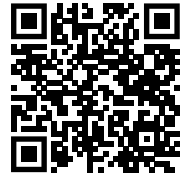

Video

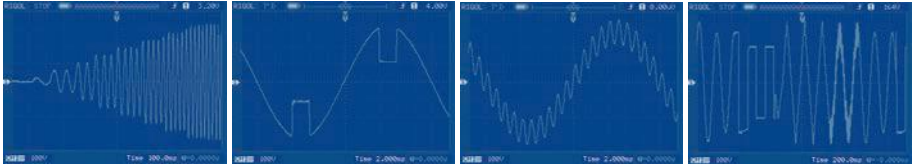

- SD card slot (optional)
- The drivers for the Lab View user interface can also be used in conjunction with a digital interface
- Sync input synchronizes the device with external sources (optional)
- Sync output triggers external measurement instruments or similar (optional)
- Disengageable output voltage via memory card or digital interface for a determined amount of half periods (optional)
- Connectable output voltage via memory card or digital interface for a determined amount of time (optional)
- Special versions available on request

APPLICATIONS

- Tripping characteristics of fuses
- Check plug connections
- Contact transitions (relay, contactor)
- Current source synchronized with a voltage source (EAC-SP)
 - Power meter 1-&3 phase calibration
 - Simulate phase shift of voltage and current



BIDIRECTIONAL AC SOURCE/SINK WITH GRID POWER RECYCLING

- 15 kVA up to 2 MVA
- Seamless transition between source and sink mode
- Output: AC, DC, AC+DC
- Output up to 2,000 Hz (-HF option)
- Add single-phase output (option -1P)
- Up to 750 V L-N Output
- Modular design
- TFT Touch Display Operation
- Mod-Bus/SCPI protocols
- LAN/RS485 interfaces (standard), RS232/analogue interfaces (optional)
- Emergency stop button
- Switchable insulation monitoring
- Remote inquiry
- CE conformity
- Special versions available on request



EAC-4Q-KS

15 kVA – 500 kVA
 Output voltages up to 750 V (L-N)
 Output currents up to 100 A
 per phase in a single system

EAC-4Q-GS SERIE

30 kVA – 2 MVA
 Output voltages up to 750 V (L-N)
 Output currents up to 758 A
 per phase in a single system

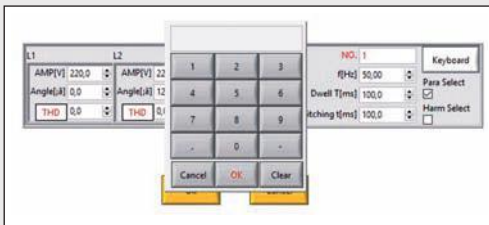

Editing the individual parameters in the sequences.

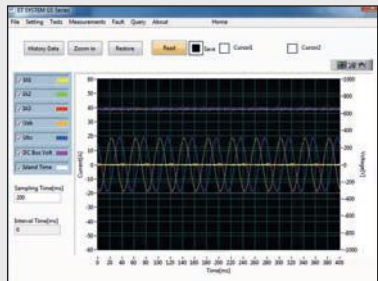

Recording the individual parameters, such as voltage and current of the individual phases.



ELECTRONIC DC LOADS

- From 150 W to 200 kW
- Input voltages up to 1,500 V
- Currents up to 1,500 A
- 6 different operating modes: CC, CR, CV, CP, CC+CV, CR+CV
- System integration
- Integrated battery tester
- Adjustable CC soft startup
- Quick response time: 2.5 A/ μ s
- Dynamic loads and test sequences
- Current, voltage, resistance and power operation
- Programmable sequences, 8 memory spaces with 200 steps that can be edited individually
- Digital interfaces RS232, RS485 and USB (optional)
- Special versions available on request

M9403 Multi-Electronic Load Test System

A practical test software which we developed in-house, which is incredibly easy to use. It enables up to 8 identical electronic loads to be tested in parallel.



Here, the electronic loads can be applied as one total load or can also be set independently of each other. They are controlled via a digital interface: RS232, RS485 or USB (optional).



ELP/DCM

150 W – 200 kW
 Voltages up to 1,500 V
 Currents up to 1,500 A
 19" x 2 U x 520,5 mm –
 19" x 20 U x 700 mm

Selectable Load Operating Modes

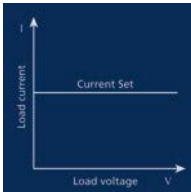

Constant Current Mode

In CC mode, the load attempts to maintain the set current, regardless of the input voltage.

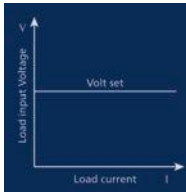

Constant Voltage Mode

In CV mode, the load attempts to keep the set voltage constant, regardless of the current.

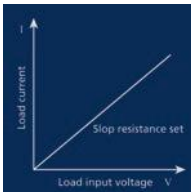

Constant Resistant Mode

In CR mode, a resistance is applied. A current flows which is linearly proportional to the voltage.

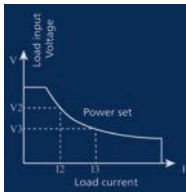

Constant Power Mode

In CP mode, a constant power is set. Thus, if the voltage drops, the current rises and vice versa.

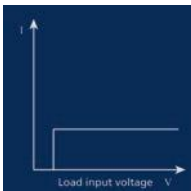

Switching from CC Mode to CV Mode

When switching from CC mode to CV mode, power supplies, for example, can be tested without destroying the specimen due to over-current or excess voltage.



Switching from CR Mode to CV Mode

When switching from CR mode to CV mode, power supplies, for example, can be tested without destroying the specimen due to over-current or excess voltage.

SYSTEM INTEGRATION

ET SYSTEM® Your partner for tailor-made solutions

ET SYSTEM® offers comprehensive solutions for system integration, in which the devices are individually retrofitted with additional components and supplied ready for use.

The sources and electronic loads, which we create in-house, can be wired according to the customer's requirements, installed in 19" cabinets and endowed with additional functions in accordance with your specifications.

The output power can also be adapted to any altered requirements at a later point in time by adding further devices using the master/slave function.

With more than 20 years of experience and our company's certification according to ISO 9001:2015, we can guarantee safety, endurance and reliability, and thus safeguard the cornerstones of your success.

Our Services at a Glance

- Customer-specific device construction
- Subsequent upgrading of output power
- Personal contact partner with a range of services, from qualified consultation to direct support by the developers
- And much, much more...



Video



Sales contact:

Tel.: +49 (0)6205 / 394 80
info@et-system.de

ET System electronic GmbH
Hauptstraße 119 – 121
D – 68804 Altlußheim
Tel.: +49 (0)6205 / 394 80
Fax: +49 (0)06205 / 375 60
info@et-system.de
www.et-system.de



ET SYSTEM®