

**Chroma**

**Milliohm Meter  
16502  
User's Manual**

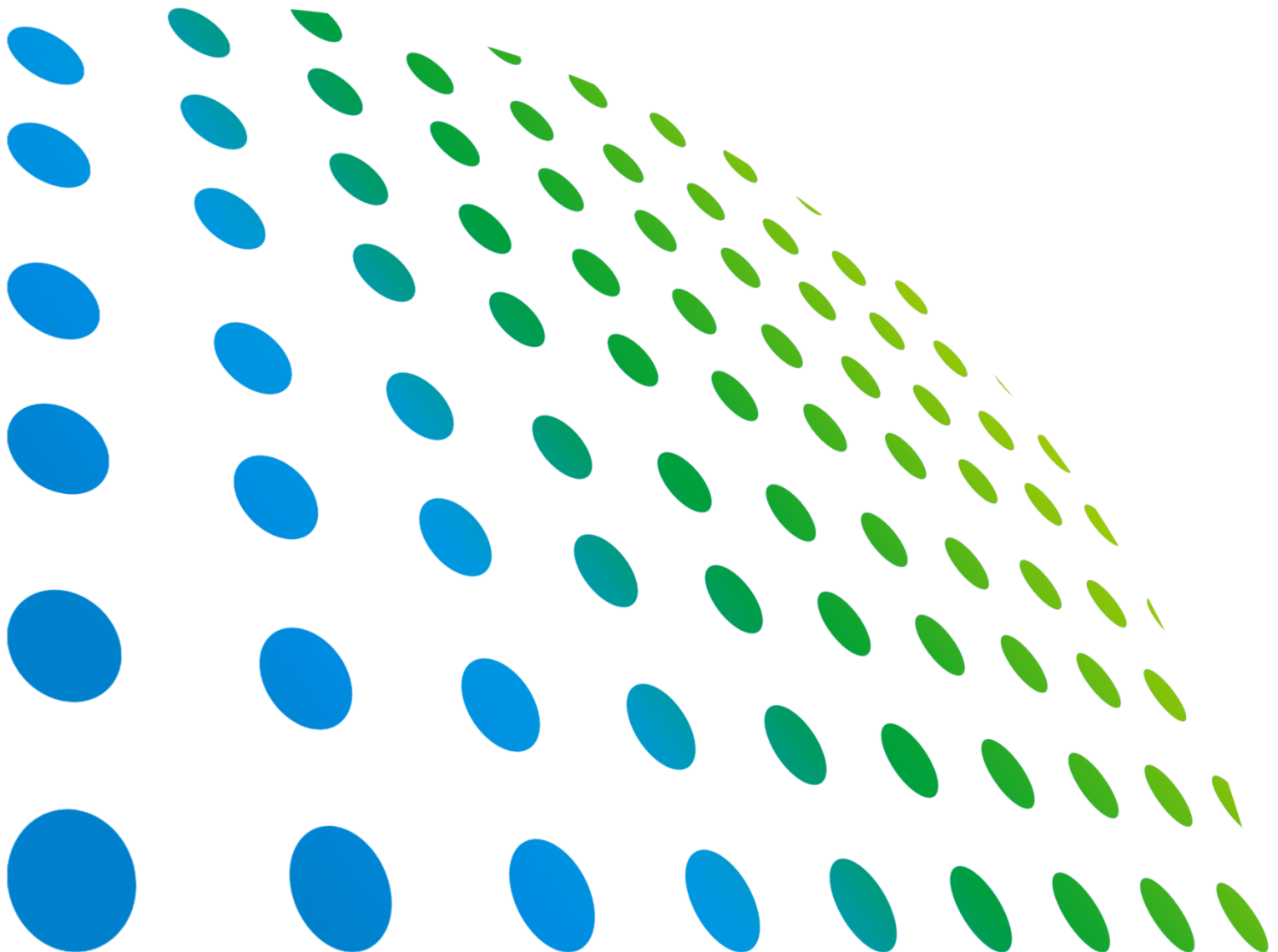



# Milliohm Meter 16502 User's Manual



Version 1.3  
March 2017

# Legal Notices

The information in this document is subject to change without notice.

Chroma ATE INC. makes no warranty of any kind with regard to this manual, including, but not limited to, the implied warranties of merchantability and fitness for a particular purpose. Chroma ATE INC. shall not be held liable for errors contained herein or direct, indirect, special, incidental or consequential damages in connection with the furnishing, performance, or use of this material.

## **CHROMA ATE INC.**

66 Huaya 1st Road, Guishan, Taoyuan 33383, Taiwan

Copyright Notices. Copyright 2010 - 2017 Chroma ATE INC., all rights reserved. Reproduction, adaptation, or translation of this document without prior written permission is prohibited, except as allowed under the copyright laws.

# Warranty

All Chroma instruments are warranted against defects in material and workmanship for a period of one year after date of shipment. Chroma agrees to repair or replace any assembly or component found to be defective, under normal use during this period. Chroma's obligation under this warranty is limited solely to repairing any such instrument, which in Chroma's sole opinion proves to be defective within the scope of the warranty when returned to the factory or to an authorized service center. Purchaser is responsible for the shipping and cost of the service item to Chroma factory or service center. Shipment should not be made without prior authorization by Chroma.

This warranty does not apply to any products repaired or altered by persons not authorized by Chroma, or not in accordance with instructions furnished by Chroma. If the instrument is defective as a result of misuse, improper repair, or abnormal conditions or operations, repairs will be billed at cost.

Chroma assumes no responsibility for its product being used in a hazardous or dangerous manner either alone or in conjunction with other equipment. High voltage used in some instruments may be dangerous if misused. Special disclaimers apply to these instruments. Chroma assumes no liability for secondary charges or consequential damages and in any event, Chroma's liability for breach of warranty under any contract or otherwise, shall not exceed the purchase price of the specific instrument shipped and against which a claim is made.

Any recommendations made by Chroma for use of its products are based upon tests believed to be reliable, but Chroma makes no warranty of the results to be obtained. This warranty is in lieu of all other warranties, expressed or implied, and no representative or person is authorized to represent or assume for Chroma any liability in connection with the sale of our products other than set forth herein.

## **CHROMA ATE INC.**

66 Huaya 1st Road, Guishan,  
Taoyuan 33383, Taiwan  
Tel: 886-3-327-9999  
Fax: 886-3-327-2886  
e-mail: [info@chromaate.com](mailto:info@chromaate.com)  
<http://www.chromaate.com>

# Material Contents Declaration

The recycling label shown on the product indicates the Hazardous Substances contained in the product as the table listed below.

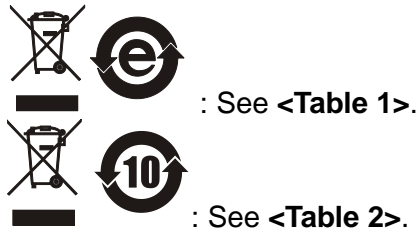

<Table 1>

Part Name	Hazardous Substances					
	Lead	Mercury	Cadmium	Hexavalent Chromium	Polybrominated Biphenyls/ Polybromodiphenyl Ethers	Selected Phthalates Group
	Pb	Hg	Cd	Cr <sup>6+</sup>	PBB/PBDE	DEHP/BBP/DBP/DIBP
PCBA	O	O	O	O	O	O
CHASSIS	O	O	O	O	O	O
ACCESSORY	O	O	O	O	O	O
PACKAGE	O	O	O	O	O	O

“O” indicates that the level of the specified chemical substance is less than the threshold level specified in the standards of SJ/T-11363-2006 and EU Directive 2011/65/EU.

“X” indicates that the level of the specified chemical substance exceeds the threshold level specified in the standards of SJ/T-11363-2006 and EU Directive 2011/65/EU.

Remarks: The CE marking on product is a declaration of product compliance with EU Directive 2011/65/EU.

## Disposal

Do not dispose of electrical appliances as unsorted municipal waste, use separate collection facilities. Contact your local government for information regarding the collection systems available. If electrical appliances are disposed of in landfills or dumps, hazardous substances can leak into the groundwater and get into the food chain, damaging your health and well-being. When replacing old appliances with new one, the retailer is legally obligated to take back your old appliances for disposal at least for free of charge.



<Table 2>

Part Name	Hazardous Substances					
	Lead	Mercury	Cadmium	Hexavalent Chromium	Polybrominated Biphenyls/ Polybromodiphenyl Ethers	Selected Phthalates Group
	Pb	Hg	Cd	Cr <sup>6+</sup>	PBB/PBDE	DEHP/BBP/DBP/DIBP
PCBA	×	○	○	○	○	○
CHASSIS	×	○	○	○	○	○
ACCESSORY	×	○	○	○	○	○
PACKAGE	○	○	○	○	○	○

“○” indicates that the level of the specified chemical substance is less than the threshold level specified in the standards of SJ/T-11363-2006 and EU Directive 2011/65/EU.

“×” indicates that the level of the specified chemical substance exceeds the threshold level specified in the standards of SJ/T-11363-2006 and EU Directive 2011/65/EU.

1. Chroma is not fully transitioned to lead-free solder assembly at this moment; however, most of the components used are RoHS compliant.
2. The environment-friendly usage period of the product is assumed under the operating environment specified in each product's specification.

### Disposal

Do not dispose of electrical appliances as unsorted municipal waste, use separate collection facilities. Contact your local government for information regarding the collection systems available. If electrical appliances are disposed of in landfills or dumps, hazardous substances can leak into the groundwater and get into the food chain, damaging your health and well-being. When replacing old appliances with new one, the retailer is legally obligated to take back your old appliances for disposal at least for free of charge.





# Declaration of Conformity

For the following equipment :

**Milliohm Meter**

(Product Name/ Trade Name)

**16502**

(Model Designation)

**CHROMA ATE INC.**

(Manufacturer Name)

**66 Huaya 1<sup>st</sup> Road, Guishan, Taoyuan 33383, Taiwan**

(Manufacturer Address)

Is herewith confirmed to comply with the requirements set out in the Council Directive on the Approximation of the Laws of the Member States relating to Electromagnetic Compatibility (2014/30/EU) and Low Voltage Directive (2014/35/EU). For the evaluation regarding the Directives, the following standards were applied :

**EN 61326-1:2013 Class A**

**EN 61000-3-2:2014, EN 61000-3-3:2013**

**EN 61326-1:2013(industrial locations)**

**EN 61000-4-2:2009, EN 61000-4-3:2006+A1:2008+A2:2010, EN 61000-4-4:2012,  
EN 61000-4-5:2006, EN 61000-4-6:2014, EN 61000-4-8:2010, EN 61000-4-11:2004**

**EN 61010-1:2010 and EN 61010-2-030:2010**

The equipment describe above is in conformity with Directive 2011/65/EU of the European Parliament and of the Council of 8 June 2011 on the restriction of the use of certain hazardous substances in electrical and electronic equipment.

The following importer/manufacturer or authorized representative established within the EUT is responsible for this declaration :

**CHROMA ATE INC.**

(Company Name)

**66 Huaya 1<sup>st</sup> Road, Guishan, Taoyuan 33383, Taiwan**

(Company Address)

Person responsible for this declaration:

**Mr. Vincent Wu**

(Name, Surname)

**T&M BU Vice President**

(Position/Title)

**Taiwan**

(Place)

**2017.02.21**

(Date)

(Legal Signature)



# Safety Summary

The following general safety precautions must be observed during all phases of operation, service, and repair of this instrument. Failure to comply with these precautions or specific WARNINGS given elsewhere in this manual will violate safety standards of design, manufacture, and intended use of the instrument. *Chroma* assumes no liability for the customer's failure to comply with these requirements.



---

## BEFORE APPLYING POWER

Verify that the power is set to match the rated input of this power supply.

---



---

## PROTECTIVE GROUNDING

Make sure to connect the protective grounding to prevent an electric shock before turning on the power.

---

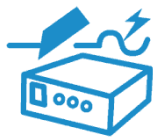

---

## NECESSITY OF PROTECTIVE GROUNDING

Never cut off the internal or external protective grounding wire, or disconnect the wiring of protective grounding terminal. Doing so will cause a potential shock hazard that may bring injury to a person.

---



---

## FUSES

Only fuses with the required rated current, voltage, and specified type (normal blow, time delay, etc.) should be used. Do not use repaired fuses or short-circuited fuse holders. To do so could cause a shock or fire hazard.

---



---

## DO NOT OPERATE IN AN EXPLOSIVE ATMOSPHERE

Do not operate the instrument in the presence of flammable gases or fumes. The instrument should be used in an environment of good ventilation.

---















---

## DO NOT REMOVE THE COVER OF THE INSTRUMENT

Operating personnel must not remove the cover of the instrument. Component replacement and internal adjustment can be done only by qualified service personnel.

---

# Safety Symbols

	<b>DANGER</b> – High voltage.
	<b>Explanation:</b> To avoid injury, death of personnel, or damage to the instrument, the operator must refer to the explanation in the instruction manual.
	<b>High temperature:</b> This symbol indicates the temperature is hazardous to human beings. Do not touch it to avoid any personal injury.
	<b>Protective grounding terminal:</b> This symbol indicates that the terminal must be connected to ground before operation of the equipment to protect against electrical shock in case of a fault.
	<b>Functional grounding:</b> To identify an earth (ground) terminal in cases where the protective ground is not explicitly stated. This symbol indicates the power connector does not provide grounding.
	<b>Frame or chassis:</b> To identify a frame or chassis terminal.
	<b>Alternating Current (AC)</b>
	<b>Direct Current (DC) / Alternating Current (AC)</b>
	<b>Direct Current (DC)</b>
	<b>Push-on/Push-off power switch</b>
	The <b>WARNING</b> sign highlights an essential operating or maintenance procedure, practice, condition, statement, etc., which if not strictly observed, could result in injury to, or death of, personnel or long term health hazards.
	The <b>CAUTION</b> sign highlights an essential operating or maintenance procedure, practice, condition, statement, etc., which if not strictly observed, could result in damage to, or destruction of, equipment.
	The <b>Notice</b> sign highlights an essential operating or maintenance procedure, condition, or statement.

# Revision History

The following lists the additions, deletions and modifications in this manual at each revision.

Date	Version	Revised Sections
Apr. 2010	1.0	Complete this manual.
Jul. 2013	1.1	Add CE Declaration Modify the contents in the sections below: <ul style="list-style-type: none"><li>- <i>“Material Contents Declaration”</i></li><li>- Table 1-1 and 1-2 in the section of <i>“Checking before Use”</i>.</li><li>- The figure in the section of <i>“Ambient Environment”</i>.</li><li>- The descriptions and figures in the section of <i>“Reference Data for Operating”</i>.</li><li>- The description and figure in the section of <i>“RS-232C Interface Connector”</i>.</li></ul>
Jul. 2016	1.2	Add <i>“CE Declaration of Conformity”</i> .
Mar. 2017	1.3	Modify the following: <ul style="list-style-type: none"><li>- <i>“Material Contents Declaration”</i>.</li><li>- <i>“CE Declaration of Conformity”</i>.</li></ul> Add <i>“User Manual Customer Feedback”</i> . For F/W revision: function addition, screen modification, command update and add/delete the content of user’s manual.



# Table of Contents

<b>1.</b>	<b>Preface.....</b>	<b>1-1</b>
1.1	An Overview of Product.....	1-1
1.2	Summary of Specification.....	1-1
1.3	Checking before Use.....	1-1
<b>2.</b>	<b>Specification (15°C ~ 35°C RH ≤ 75%) .....</b>	<b>2-1</b>
2.1	Measurement Function.....	2-1
2.2	Accuracy .....	2-1
2.3	Zero .....	2-1
2.4	Measurement Time.....	2-2
2.5	Temp. Measurement/Correction Spec. ....	2-2
2.6	Others .....	2-2
<b>3.</b>	<b>Installation.....</b>	<b>3-1</b>
3.1	Ambient Environment .....	3-1
3.2	Power Line Connection .....	3-1
3.3	Fuse .....	3-1
3.4	Power Regulation .....	3-2
3.5	DUT Connection.....	3-2
<b>4.</b>	<b>Description of Panel .....</b>	<b>4-1</b>
4.1	Front Panel .....	4-1
4.2	Rear Panel .....	4-2
4.3	Setting for Operation .....	4-3
4.3.1	Setting the System Parameters (System Setup).....	4-3
4.3.2	Memory Manage .....	4-6
4.4	Operation Instruction .....	4-7
4.4.1	Operating the Measurement Setting.....	4-7
4.4.2	COMPARE Setting .....	4-9
4.4.3	BINNING Setting .....	4-10
4.5	Reference Data for Operating .....	4-12
<b>5.</b>	<b>Descriptions of GPIB Interface (Commands Same as RS232 Interface) .....</b>	<b>5-1</b>
5.1	Overview .....	5-1
5.2	Specification of IEEE-488 Interface.....	5-1
5.2.1	IEEE-488 Interface Function .....	5-1
5.2.2	Code Used for Data Transfer.....	5-1
5.2.3	TALK/LISTEN Function .....	5-1
5.2.4	IEEE-488 Interface Connector.....	5-2
5.2.5	Signal Cable of IEEE-488 Interface .....	5-2
5.2.6	Port Driver .....	5-3
5.2.7	Response of Interface Message.....	5-3
5.3	GPIB Commands Description (IEEE 488.2).....	5-3
5.3.1	Command Structure .....	5-3
5.3.2	Description of Command Structure.....	5-5
5.3.3	Command Description.....	5-7
5.3.4	Common Use Commands .....	5-19
5.4	Status Reporting Structure .....	5-21
5.5	Status Byte Register.....	5-22
5.6	Standard Event Status Register .....	5-23
5.7	Operating Status Group .....	5-24
5.8	RS-232C Interface Connector .....	5-24
5.9	RS-232C Signal Line and Pin Assignment.....	5-25
<b>6.</b>	<b>Description of ZERO Correction .....</b>	<b>6-1</b>

<b>7.</b>	<b>Description of Handler Interface.....</b>	<b>7-1</b>
7.1	Description of Handler Interface Pins for BINNING.....	7-1
7.2	Description of Handler Interface Pins for COMPARE.....	7-2
<b>8.</b>	<b>Descriptions of Temperature Measurement and Correction Function.....</b>	<b>8-1</b>
8.1	Description for Temperature Measurement Function.....	8-1
8.1.1	Optional Interface for Measuring Temperature .....	8-1
8.1.2	Probe .....	8-1
8.2	Operation for Temperature Measurement .....	8-2
8.2.1	Conversion Function .....	8-2
8.2.2	Description for Setting Menu .....	8-3
8.2.3	Description for Operating Menu.....	8-4
8.2.4	Operation Example.....	8-6
8.3	Description for Temp. Correction Function.....	8-7
8.3.1	Setting Description .....	8-7
8.3.2	Operating Description.....	8-8
8.3.3	Operation Example.....	8-10
<b>9.</b>	<b>R SCAN Function.....</b>	<b>9-1</b>
9.1	R Scan Interface .....	9-1
9.2	R Scanner Specification .....	9-2
9.3	Operation for R SCAN.....	9-3
9.3.1	R SCAN Setting Step .....	9-3
9.3.2	Test Description for R SCAN .....	9-4

# 1. Preface

## 1.1 An Overview of Product

The **16502 Milliohm Meter** is an automatic instrument used for measuring and analyzing resistance. The unit was designed to solve the problems of low labor efficiency and low product quality that have occurred since the electronics sector began to flourish.

The measuring functions included in this unit are versatile inductive components: DC resistance precision measuring of Cable, Connector, Relay contacts and conductor material which supply the perfect functions on the production line and in quality control.

By using auto mode of the internal control and measuring function of programmable mode, the unit can support highly accurate, convenient, fast and reliable testing at low cost. The functions are as following: Hi or Lo-limit comparison and binning test, testing signal mode selection, data store memory, GPIB interface control 16502 and data transfer, and statistics analysis function from PC. The unit can send the test results to an external unit for checking the response of the component by handler interface.

The multi-functions testing device, ergonomics keyboard design, guided panel operation, extra-large LCD, and password protection makes the 16502 easy to operate and the test results are clearly showed on the display.

The basic accuracy is 0.05%. The measurement device (optional) can perform the calibration by keying-in the measuring parameter. The calibration procedure can be finished easily for users by offering ZERO.

## 1.2 Summary of Specification

- Measurement Parameter:  $R_x$
- Basic Accuracy: Basic 0.05%
- Measurement Range:  $R_x$  --  $0.001\text{m}\Omega \sim 2.0000\text{M}\Omega$
- Measurement Current: Fixed current 1A(MAX; range =  $20\text{m}\Omega$ )
- Zeroing Calibration: ZEROING
- Interfaces: GPIB interface, RS-232

## 1.3 Checking before Use

Upon receipt of this instrument, please check the items as the following and save all packing materials in case that the instrument has to be returned.

(1) Any damages or scratches on the surface of the product.

(2) Listed in *Table 1-1* and *Table 1-2* are accessories for this instrument.

If damage is found, please file claim with carrier immediately. Do not return the instrument to Chroma without prior approval.



<b>Item</b>				
<b>Name</b>	Power Cord 1.8M*1pc	Power Connector 3PIN to 2PIN* 1pcs	16502 User's Manual CD*1	16502 Quick Start Guide Traditional Chinese * 1pc
<b>Item</b>				
<b>Name</b>	16502 Quick Start Guide English * 1pc	AC 220V used 0.5A/250V Fuse *2pcs	AC 110V used 1A/250V Fuse *2pcs	Test Cable (4-Terminal) For clipping of DUT *1pc

Table 1-1 Standard Accessory

<b>Item</b>	<b>Q'ty</b>	<b>Remark</b>
A165013 GPIB, Handler & temperature compensation card for 16502	1	With GPIB, Handler & temperature measurement functions
A165014 temperature compensation card for 16502	1	Temperature measurement function only
A165015 Temperature Probe	1	PT100 is used with temperature measurement
A110235 GPIB & Handler Card	1	GPIB & Handler function

Table 1-2 Optional Accessory

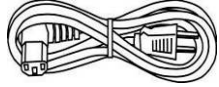
**Note** : Only the part number is required for obtainment of the missing or purchase of a new one.

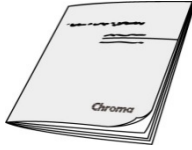
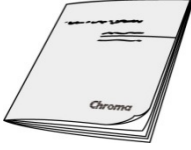
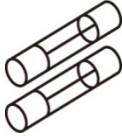
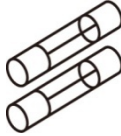
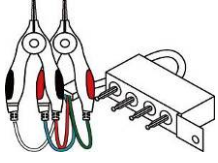

## 2. Specification (15°C ~ 35°C RH ≤ 75%)

### 2.1 Measurement Function

**Parameter:**  $R_x$

**Range:** Auto, Manual

**Trigger mode:** Internal, Manual and External (GPIB, Handler Interface)

**Measuring terminals:** 4-terminal

**Measuring speed:** FAST, MEDIUM, SLOW

### 2.2 Accuracy

- Within 1 year of factory calibration.
- Temperature: 23°C ± 5°C
- Relative humidity: <90% RH
- Warm up: 30 minutes minimum
- Zero calibration under above conditions.

Mode		Dry Circuit = OFF				Dry Circuit = ON		
		Speed			Limit Current	Speed		
Range	Resistance	Slow	Medium	Fast			Slow	Medium
2 MΩ	2 MΩ 200 kΩ	A=0.30 B=0.01	A=0.45 B=0.02	A=1.00 B=0.03	1uA typical	—	—	—
200 kΩ	200 kΩ 20 kΩ	A=0.20 B=0.01	A=0.30 B=0.02	A=0.40 B=0.03	10uA typical	—	—	—
20 kΩ	20 kΩ 2 kΩ	A=0.10 B=0.01	A=0.15 B=0.02	A=0.20 B=0.03	100uA typical	—	—	—
2 kΩ	2 kΩ 200 Ω	A=0.05 B=0.01	A=0.10 B=0.02	A=0.15 B=0.03	1mA typical	—	—	—
200 Ω	200 Ω 20 Ω	A=0.05 B=0.02	A=0.10 B=0.04	A=0.15 B=0.06	1mA typical	—	—	—
20 Ω	20 Ω 2 Ω	A=0.05 B=0.03	A=0.10 B=0.05	A=0.15 B=0.08	1mA typical	A=0.35 B=0.20	A=0.50 B=0.20	A=0.70 B=0.20
2 Ω	2 Ω 200 mΩ	A=0.05 B=0.03	A=0.10 B=0.05	A=0.15 B=0.08	10mA typical	A=0.35 B=0.20	A=0.50 B=0.20	A=0.70 B=0.20
200 mΩ	200 mΩ 20 mΩ	A=0.05 B=0.03	A=0.10 B=0.05	A=0.15 B=0.08	100mA typical	A=2.50 B=0.50	A=3.00 B=0.50	A=4.00 B=0.50
20 mΩ	20 mΩ 10 mΩ	A=0.10 B=0.03	A=0.15 B=0.05	A=0.20 B=0.08	1A typical	—	—	—

Accuracy = ±(A % of Reading + B % of Full Range)

### 2.3 Zero

**Zeroing:** Eliminate measurement errors due to short residual impedances of the test fixture.

## 2.4 Measurement Time

Begin from measuring, analog sampling, calculation to binning or compare signal output measurement time. Please refer to the *Table 2-1*.

Item	Fast	Medium	Slow
Measurement time	65 mS	150mS	650 mS

Table 2-1 Measurement Time

## 2.5 Temp. Measurement/Correction Spec.

Measurement Range	Measurement Accuracy (PT100 temperature probe excluded)	Correction Accuracy resistance measurement accuracy need to be added)
-10.0 °C ~ 39.9°C (-14.0 ~ 103.8°F)	±0.3% of the reading ±0.5°C (0.9°F)	±0.3%
40.0 ~ 99.9°C (104 ~ 211.8°F)	±0.3% of the reading ±1.0°C (1.8°F)	±0.6%

- Note**
1. Temperature measurement function need to cooperate with optional function interface and probe for operating.
  2. It is necessary to plus the tolerance of probe as temperature measuring (the type of PT100 temperature probe is <math>\pm 0.5^{\circ}\text{C}</math>).

## 2.6 Others

- **Power:** (1) 90V ~ 125V AC 50Hz/60Hz. Power consumption is 80VA.  
(2) 190V ~ 250V AC 50Hz/60Hz. Power consumption is 80VA.
- **Environment:** Operating -- 10°C to 40°C, 10 to 90% relative humidity  
Storage -- 0°C to 50°C, 10 to 90% relative humidity
- **Dimension:** 320(W) x 115(H) x 350(D) (Foot pad and terminals are not included)
- **Weight:** Approximately 5.5 Kg

## 3. Installation

### 3.1 Ambient Environment

- (1) Do not use the meter in a dusty or vibrating location. Do not expose it to sunlight or corrosive gas. Please be sure that the ambient temperature is 0 ~ 40°C and that the relative humidity is below 90%.
- (2) The rear panel of the meter is equipped with a cooling fan to keep internal temperature rising, so adequate ventilation should be ensured. The meter should be located at least 10cm from any object or wall behind it. Do not block the left and right ventilation holes to keep the meter in good precision.
- (3) The meter has been carefully designed to reduce the noise from AC power source. However, it should be used in a noise environment as low as possible. If noise is inevitable, please install a power filter.
- (4) The meter should be stored within the temperature range 0°C ~ 50°C. If the unit is not to be in use for a long time, please store it in the original or similar package and keep it from direct sunlight and humidity for ensure good condition in later use.

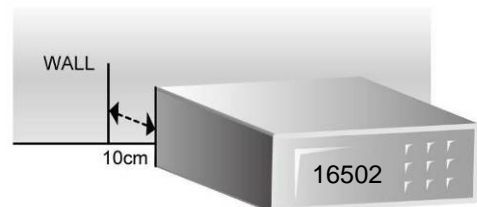
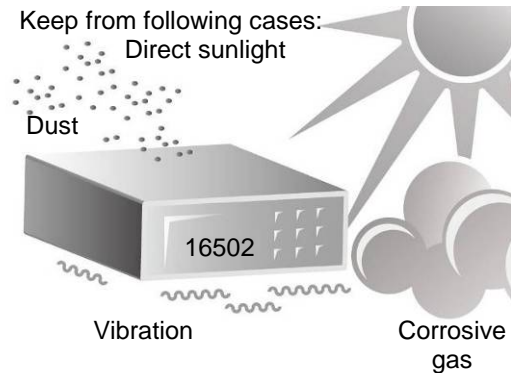

Keep from objects in the behind at over 10cm

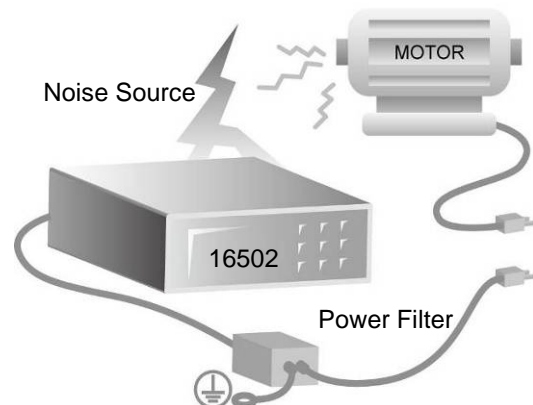

Please install the power filter in case of interface from high power noise

### 3.2 Power Line Connection

Before plugging in the power cord, please make sure the power switch is off and the voltage selector on the rear panel meets the required voltage. Please use the power supply frequency of 50 Hz or 60Hz.

### 3.3 Fuse

There is one fuse installed on the rear panel. When replacing the fuse, please turn off the power and pull the plug from the power supply.

Fuse spec. AC 100V ~ 120V → T1.0A 250V  
AC 220V ~ 240V → T0.5A 250V

For reasons of safety and noise reduction, it is necessary to use three-wire line for connecting AC line input of rear panel, and connects GROUND terminal of front panel to earth. Illustration is as following:

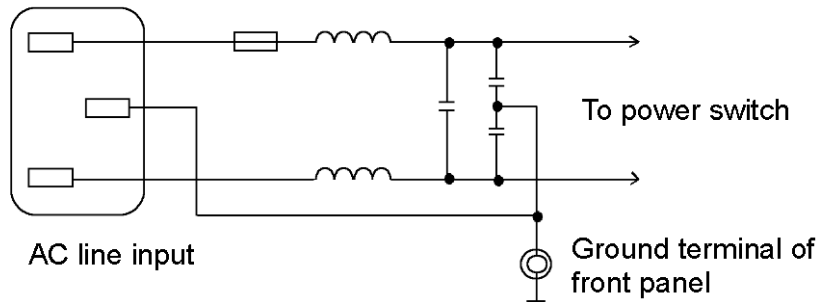

### 3.4 Power Regulation

As this instrument is a precision electronic test device, so the accuracy is possible to be influenced seriously by input power unstable after testing. There is  $\pm 10\%$  changeable power even in the laboratory, so we suggest that use the regulator in power and test devices is the only one way to avoid the reasons that cause by power unstable.

### 3.5 DUT Connection

For connecting the 16502 Milliohm Meter to D.U.T can through banana plugs which marked DRIVE (+), DRIVE (-), SENSE (+) and SENSE (-), thus needs external test device usually.

**⚡ CAUTION** : DRIVE (-) and SENSE (-) connect to DUT should be at the same terminal, DRIVE (+) and SENSE (+) connect to another terminal.

## 4. Description of Panel

### 4.1 Front Panel

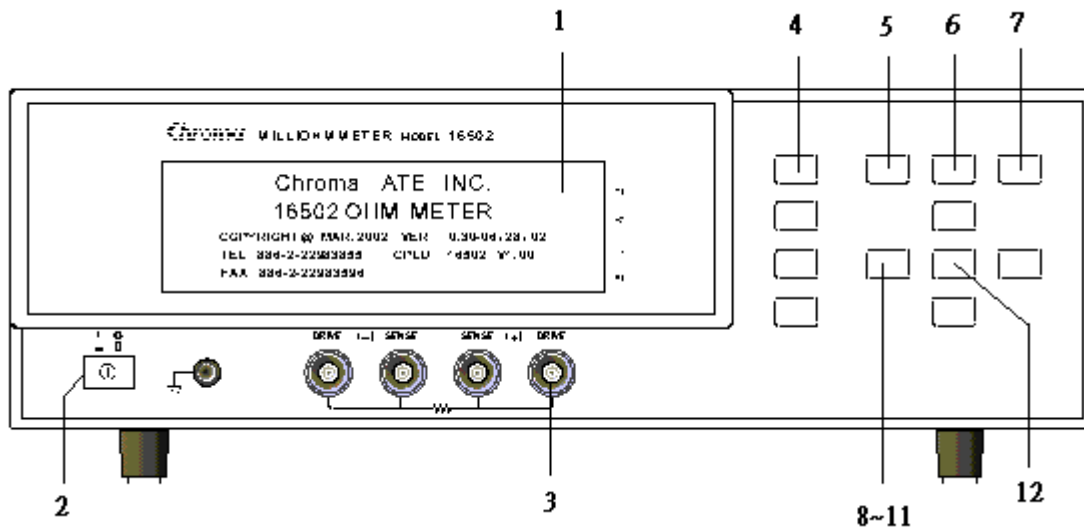

#### (1) LCD Display

The resolution of this instrument display is 240 x 64 dot-matrix LCD display, so all the measuring and setting values can be shown clearly.

#### (2) Power Switch

On-off switch

#### (3) Unknown DUT Sockets

Four individual BNC sockets connect an external test device or wire for unknown testing.

DRIVE(+): Current drive terminal, high potential terminal

SENSE(+): Potential detect terminal, high potential terminal

SENSE(-): Potential detect terminal, low potential terminal

DRIVE(-): Current drive terminal, low potential terminal

**CAUTION** When the polarity component is under test, "high potential terminal" connects to (+) and "low potential terminal" connects to (-) which are marked on front panel.

**WARNING** To avoid damaging the instrument, please discharge before measuring the polarity components.

#### (4) Function Keys

There are four function keys, the major function of these keys are to show different conditions of each keys or other options which may need to be selected depending on the user's requirements.

#### (5) MEAS DISPLAY KEY

Upon pressing this key, the instrument is under component basic measurement analysis mode. Under this screen, each test parameter can be changed directly and the value can be read. For example, test mode, test speed and ZERO etc.

**Note** If the user wants to reserve test mode setting parameter after powered-off. The user can press System Setup Key on front panel under test screen as well as press Meas Display Key then returns to test screen. After the above steps are completed, please turn off the unit.

**(6) MAIN INDEX Key**

Pressing this key allows entry to the main index screen. In this screen you may select what you want to test, DUT test result binning and compare function.

**(7) SYSTEM SETUP Key**

Pressing this key gives access to the main system parameters setup, allowing each system parameter to be changed directly, e.g., the calibration of this instrument, memory management, selection and setting of each system and measurement parameter. (The functions of calibration and memory-management require a password for entry).

**(8) ~( 11 ) Cursor Keys**

There are [△], [▽], [◀], [▶] four direction keys. These keys are for display in different conditions and control cursor, which can be useful when inputting each parameter. The keys can also be selection keys, e.g., selecting range by [◀], [▶] keys.

**(12) TRIGGER Key**

This key is for trigger instrument to start measurement. When the instrument is in manual trigger mode, press this key for measuring.

## 4.2 Rear Panel

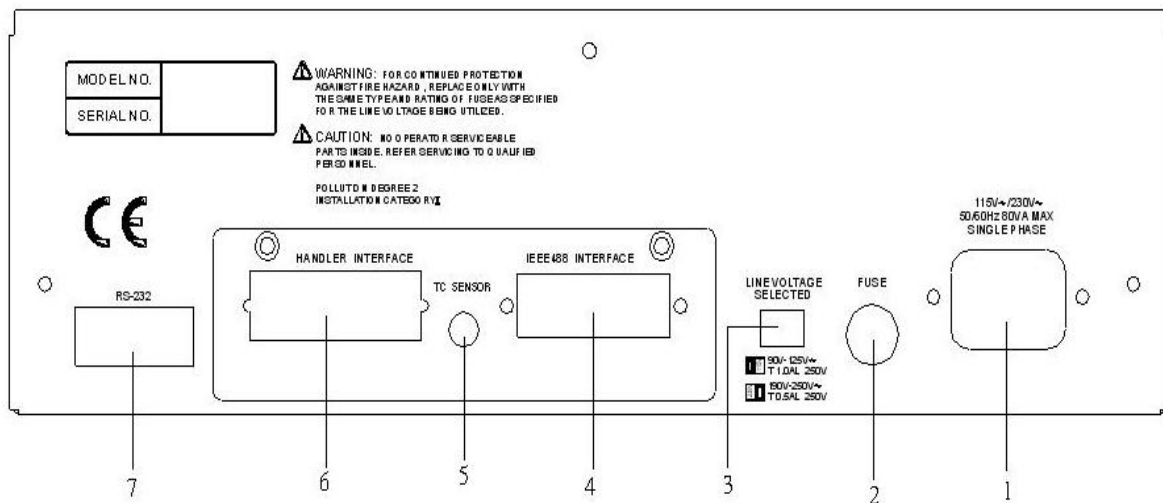

**(1) AC Line Socket**

This socket is an approved (by the International Electrotechnical Commission) three-wire socket 320. Please use the correct wire, such as Beeline SPH-386 or similar power cord (W12 010130).

**(2) Fuse**

1.0A or 0.5A slow blow fuse to prevent the instrument being affected by excess current in 90 ~ 125V or 190 ~ 250V.

**(3) Power Voltage Switch**

Ensure power is off, then use screwdriver to switch to required voltage.

**(4) IEEE-488 INTERFACE Socket (Option)**

According to IEEE488-1978 standard input/output cord. The functions are: total remote control, output selection result, with or without controller, receives IEEE-488 interface connection line.

**(5) TC SENSE Socket (Option)**

The connection socket of temperature probe is mainly for temperature measuring.

**(6) HANDLER INTERFACE Socket (Option)**

To component controller, output is GO/NG status etc., input is "Start" signal. Receive Amphenol "Microribbon" plug P/N 57-30240 or equivalent object.

**(7) RS-232 SERIES PORT**

Standard RS-232 interface.

## 4.3 Setting for Operation

### 4.3.1 Setting the System Parameters (System Setup)

1. Power on the meter and the LCD will prompt the company name, its phone and fax number as well as the model number of this instrument along with the firmware version as shown below:

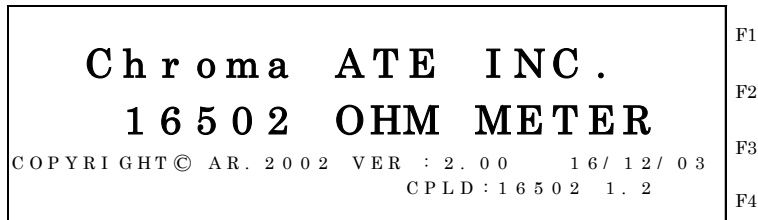

**Note** | Press [System Setup] and [◀] at any time can show this screen when the meter is powered on.

2. The meter will run self test after powered on for 1 second, and then it will enter the following measurement screen:

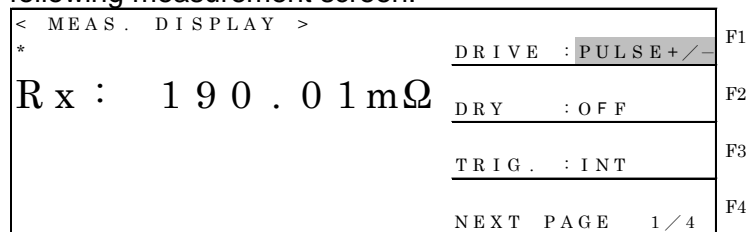

3. To set the system parameters, press [System Setup] after powered on. It will enter the following screen:

< SYSTEM SETUP >		
	CALBRATION	F1
	MEM MANAGE	F2
	SYSTEM CONFIG	F3
		F4

← Enter System Calibration Screen  
← Enter Memory Manage Screen  
← Set the System Parameter

4. Press [F3] (i.e. SYSTEM CONFIG) to enter the system parameter setting screen as shown below:

< SYSTEM CONFIG >		
	DIGIT UP	F1
AVERAGE NO. : 01	DIGIT DOWN	F2
BEEPER : HIGH		F3
KEY LOCK : OFF		F4
CONTRAST : 07		
SOUND MODE : FAIL		

5. There are 4 pages for system setting. Press the up and down arrow keys to move to the next page. Following shows the second page:

< SYSTEM CONFIG >		
	PULSE	F1
ALARM MODE : PULSE	CONTINUOUS	F2
TRIG. DELAY : 0000mS		F3
TRIG. EDGE : FALLING		F4
HANDLER MODE : CLEAR		
MEAS. DELAY : 0.000S		

The following shows the third page.

< SYSTEM CONFIG >		
	50Hz	F1
LINE FRE. : 60Hz	60Hz	F2
GPIB ADDRESS : 17		F3
BAUDRATE : 19200		F4
CORREC. TEMP : +20.0 °C		
THERM. COEFF. : 3930 ppm		

The following shows the fourth page.

< SYSTEM CONFIG >		
	PT100	F1
TEMP. PROBE : PT100	PT500	F2
AUTO REPORT : OFF		F3
COMP. DISP. : ON		F4
PADR OFFSET : +0.0 mΩ		

6. Below explains the setting of system parameters:

**AVERAGE NO. :**

This function is to calculate the periodic sampling. The measuring range is 01~10. The factory default value is "04". When the samplings are less, then the speed becomes fast but its stability is decreasing. On the other hand, when the samplings are getting more, then the speed becomes slowly, also its stability is increasing.

**BEEPER:**

It sets the warning beep volume to OFF, LOW, and HIGH. The default setting is HIGH.



**KEY LOCK:**

It locks the key. The default setting is OFF. Switch to MEASURE DISPLAY or BIN COUNT or COMPARE COUNT the word <LOCK> will appear at upper right of test screen when it is on. To disable it, press [F1], [F4], and [SYSTEM SETUP].

**CONTRAST:**

LCD contrast adjustment range is 0 ~ 13. The default setting is "7".

**SOUND MODE:**

FAIL: It beeps when detected no good product during performing the measurement of BIN or COMPARE.

PASS: It beeps when detected good product during performing the measurement of BIN or COMPARE.

The default setting is FAIL.

**ALARM MODE:**

PULSE: It sets the warning to a short beep during good/no good product judgment.

CONTINUE: It sets the warning to a continuous long beep during good/no good product judgment.

The default setting is PULSE.

**TRIG. DELAY:**

It is to adjust the time delayed for measurement when the meter receives the trigger signal. The range is from 0 to 1000mS, and the default setting is 0000mS. All trigger modes will be affected by this setting.

**TRIG. EDGE:**

It sets the RISING and FALLING edge trigger. The default setting is FALLING edge trigger.

**HANDLER MODE:**

CLEAR: When the Handler interface is in use, it will clear the output signal (PASS or FAIL) of previous tested result before measuring.

HOLD: When the Handler interface is in use, the output signal (PASS or FAIL) of tested result will remain until the next test result shows otherwise.

The default setting is CLEAR.

**MEAS. DELAY:**

The time delayed before measuring each time, the range is 0.000 ~ 100 seconds. The setting method is by using [F1] key (DIGIT UP) or [F2] key (DIGIT DOWN) to adjust.

Its interval time in 5mS~100mS is 5mS, 0.1~100S is 0.1S. Please see section 4.5 *Reference Data for Operation*.

**LINE FREQ.:**

It sets the line frequency to 50Hz or 60Hz for AC110V/220V power source. The default setting is 60Hz.

**GPIB ADDRESS:**

It sets the GPIB interface address. The default setting is 17 and the range is from 01 to 30.

**BAUDRATE:**

It sets baud rate of RS232 serial port. There are 1200, 2400, 4800, 9600, 19200, 38400 six selections. By using [F4] key is to switch setting value selection of up/down page.

The default setting is 19200.

**CORREC.TEMP**

It sets the specified temperature value  $t_0$  (°C) that you want to convert in temperature correction function. The default setting is +20.0°C.

**THERM.COEFF**

It sets the coefficient  $\alpha_0$  in temperature correction function. The default setting is 3930 ppm.

**TEMP .PROBE**

It sets the type of probe for measuring temperature. There are two types of PT100 and PT500. The default setting is PT100.

**AUTO REPORT**

It sets if measurement data and result are sent by RS232 interface automatically but trigger mode is invalid when it is set to internal trigger (INT). The factory default setting is OFF. The sent formats of each measurement function when the setting ON are as the following: (the data in bracket ([]) only exist when the function is activated)

<MEAS. DISPLAY> : Rx[,Compare Result][,Binning Result][, AMBIENT TEMP. ]

<TEMP CONV. MEAS.>:Rx,T, [,AMBIENT TEMP.]

<R SCAN TEST> : [R1,R1 Result][,R2.,R2 Result][,R3,R3 Result],  $\Delta R$ ,  $\Delta R$  Result, Total PASS/FAIL[,AMBIENT TEMP.] PS: The data won't be sent when R1~R3 doesn't execute the test.

**COMP. DISP.:**

It sets compare test result of displaying high/low limit, two options of do not show test result (OFF) and show test result (ON). The factory default value is not showing test result (OFF).

**PADR OFFSET**

The pad bias offset of contact end as measuring the instrument, the setting range -50.0m $\Omega$  ~ +50.0 m $\Omega$ . The factory default value is +0.0 m $\Omega$ .

### 4.3.2 Memory Manage

In SYSTEM SETUP, press [F2] (i.e. MEMORY MANAGE) it will show the following screen:

< SYSTEM SETUP >	CALBRATION	F1 ← Enter System Calibration Screen
	MEM MANAGE	F2 ← Enter Memory Manage Screen
	SYSTEM CONFIG	F3 ← Set the System Parameter
		F4

Enter the correct password to access the Memory Manage function as below shown.

< MEM MANAGE >	F1
PLEASE ENTER	F2
PASSWORD . . .	F3
. . . . .	F4

## 4.4 Operation Instruction

### 4.4.1 Operating the Measurement Setting

1. After turning the instrument on and ensuring every event is OK, then enter Rx parameter test as the following menu.

< MEAS . DISPLAY >		F1 ← Select test mode
*	DRIVE : PULSE +/-	
R <sub>x</sub> : 190.01mΩ	DRY : OFF	F2 ← Select DRY CIRCUIT OFF or ON
	TRIG . : INT	F3 ← Select trigger mode
	NEXT PAGE 1/4	F4 ← Switch to next page (Now is page 1)

< MEAS . DISPLAY >		F1 ← Select range
*	RANGE : A 200mΩ	
R <sub>x</sub> : 190.01mΩ	SPEED : FAST	F2 ← Select test speed
	ZERO : OFF	F3 ← Select zero function OFF or ON
	NEXT PAGE 2/4	F4 ← Switch to next page (Now is page 2)

< MEAS . DISPLAY >		F1 ← High, low limit compare setting
*	COMPARE : OFF	
R <sub>x</sub> : 190.01mΩ	BINNING : OFF	F2 ← Binning setting
	TEMP . : OFF	F3 ← Temperature correction measurement setting
	NEXT PAGE 3/4	F4 ← Switch to next page (Now is page 3)

< MEAS . DISPLAY >		F1 ← DC+ NA Mode Value OFF or ON
*	UNDCNA : OFF	
R <sub>x</sub> : 190.01mΩ		F2
		F3
	NEXT PAGE 4/4	F4 ← Switch to page 1 (Now is page 4)

#### Notices:

The 16502's panel displays the resistance value dividing into two kinds of RX and RTC. Among these two, RX is only for measuring resistance value and it won't be affected by the temperature measurement result. RTC represents the instrument being with the functions of temperature measurement and correction, thus the display value of resistance

will be influenced by the temperature measurement result.

Therefore, if you only measure the resistance value please be sure TEMP.: (F3) is OFF as well as panel display is RX.

2. Parameters settings are as following descriptions:

**DRIVE:**

Test mode setting, please see section 4.5 *Reference Data for Operation*. There are PULSE+/-, PULSE+, PULSE-, DC+, DC-, DC+ NA, STBY six modes. The default value is PULSE+/- . Press [F1] key to switch directly in sequence.

PULSE+/-: It offers positive/negative square wave levels for switching SOURCE signal of +2V→0V →-2V→0V DC.

PULSE+ : It offers positive square wave level for switching SOURCE signal of +2V→0V DC.

PULSE- : It offers negative square wave level for switching SOURCE signal of -2V→0V DC.

DC+ : It offers SOURCE signal of DC+2V level.

DC - : It offers SOURCE signal of DC-2V level.

DC+NA : It offers SOURCE signal of DC+2V level (for speed acceleration). For circuit offset error during process doesn't run measurement.

STBY : It is under STANDBY status.

**DRY:**

DRY CIRCUIT is with OFF and ON two modes. The default value is OFF. By pressing [F2] to switch directly. When DRY = ON, the test terminal on front panel provides 20mV of maximum test voltage, it can prevent DUT from the danger of burning.

**TRIG.:**

Trigger mode. There are **INT**ernal, **EXT**ernal, **MAN**ual and SMT (SMART TRIG) four modes. By pressing [F3] to switch directly, the default value is INT.

**RANGE:**

Range setting. A represents Auto (Auto skip range), H represents Hold (Manual fixed range). Press [F1] key, then press [◀], [▶] direction keys to move the cursor to range number, and press [△], [▽] for switching. There are 2MΩ, 200KΩ, 20KΩ, 2KΩ, 200Ω, 20Ω, 2Ω, 200mΩ and 20mΩ nine ranges. (When DRY CIRCUIT = ON, 20Ω, 2Ω and 200mΩ ranges only)

**SPEED:**

Measuring speed setting. MAX means maximum speed, V.FAST means very fast, FAST means high speed, MEDIUM means middle speed, SLOW means low speed, the lower of speed, the more stable in stability. Press [F2] to switch measuring speed directly. Factory default value is FAST.

**ZERO:**

Zero setting. Can deduct residual impedance from test fixture or test cable. Press [F3] directly to select OFF or ON. Factory default value is OFF.

**COMPARE:**

High/low limit compare setting. There are OFF, ON, ON-△%, ON-△ four selections. Press [F1] for switching. This parameter is for high/low limit and central value setting under MAIN INDEX menu.

**BINNING:**

Binning setting. Press [F2] to switch OFF/ON. If setting is “ON” it will show “BIN X” word under measurement screen. This parameter is set under MAIN INDEX menu.

**TEMP.:**

It includes the functions of temperature measurement and correction. There are three types of selections OFF, AUTO and +20°C. Press [F3] for switch under the third page, +20°C is the value of inputted manually. The actual display value depends on the main unit, +20°C is an example so the shown numeral isn’t always 20. The detailed operations please see 8.3.2 *Operating Description*.

**UNDCNA:**

It should coordinate with the setting for use (the necessary setting) under MAX measurement speed and DC+ NA test mode. Press [F1] to switch Off/ON under the screen.

**<<There is a symbol “\*” on upper left side, when measuring it will turn clockwise repeatedly, and its turning speed is changed by measuring speed FAST/ MEDIUM/ SLOW. Trigger once the symbol will turn once under manual trigger. External trigger is the same as manual trigger. >>**

### 4.4.2 COMPARE Setting

1. Power on the instrument after all are normal, enter main index by pressing [MAIN INDEX] as below shown.

< MAIN INDEX >		
COMPARE		F1 ← High, low limit compare test
BINNING		F2 ← Binning test
TEMP. CONV.		F3 ← Temp. conversion setting
R SCAN		F4 ← R SCAN setting

Press [F1] to enter compare setting screen as below shown:

< MAIN INDEX : COMPARE >		
SETTING		F1 ← Condition setting
		F2
		F3
		F4

Enter “COMPARE SET” as below shown.

< COMPARE SET >		
DIGIT UP		F1 ← The cursor positioned number digit up.
DIGIT DOWN		F2 ← The cursor positioned number digit down.
DIGIT		F3 ← The cursor move right.
MODE : ABS		F4 ← Set high/low limit value is ABS (absolute value) or % (percentage).
NOMINAL : 000.0000 Ω UPPER : 000.0000 Ω LOWER : 000.0000 Ω  Press MAININDEX to exit		

**Setting example:** Assumed NOMINAL is set to 100mΩ, please follows the below method

to operate:

- (1) Press [F4], set MODE to percentage (%).
- (2) Press [F3] to move the cursor to NOMINAL position, and move the cursor to hundred then press [F1] key to adjust the number to 1. Press [F3] key to move the cursor to (-) position, then press [F1] key to set unit to m.
- (3) Press [▽] to move the cursor to UPPER position, at this time the cursor stay at hundred then press [F3] to move the cursor to the first decimal place then press [F1] (digit up) to adjust the number to 1.
- (4) After the last setting is completed, press [TRIGGER] key then the cursor will move to the next item – LOWER, the setting is -001.0000%.
- (5) After the setting is completed the menu should be as the following:

< COMPARE SET >		
NOMINAL : 100.0000 mΩ	DIGIT UP	F1
UPPER : +001.00%	DIGIT DOWN	F2
LOWER : -001.00%	DIGIT	F3
Press MAIN INDEX to exit	MODE : %	F4

After the setting is completed, press [MAIN INDEX] to exit. Press [MEAS DISPLAY] key back to page 3 of measurement menu, select [F1] key to enable COMPARE function for setting ON, ON-△% and ON-△.

As the following menu:

< MEAS. DISPLAY >		
* R <sub>x</sub> : 100.02 mΩ	COMPARE : ON-△	F1 ← Select ON, ON-△% and ON-△
△ : 00.02 mΩ	BINNING : OFF	F2
PASS	TEMP. : OFF	F3
	NEXT PAGE 3/4	F4

Please set warning sound of COMPARE function under SOUND MODE of SYSTEM CONFIG screen.

### 4.4.3 BINNING Setting

1. Power on the instrument after all are normal, enter main index by pressing [MAIN INDEX] as below shown.

< MAIN INDEX >		
	COMPARE	F1
	BINNING	F2 ← Binning test
	TEMP. CONV.	F3
	R SCAN	F4

Press [F2] to enter binning setting screen as below shown:

< MAIN INDEX : BINNING >		
	SETTING	F1 ← Condition setting
		F2
		F3
	COUNT	F4 ← Counter

Press [F1] to enter setting screen as below shown:

< BINNING SET >		
	DIGIT UP	F1 ← The cursor positioned number digit up.
NOMINAL : 000.0000 Ω	DIGIT DOWN	F2 ← The cursor positioned number digit down.
	DIGIT	F3 ← The cursor move right.
Press down arrow to set bins	VIEW	F4 ← Display high/low limit of binning set.
Press MAIN INDEX to exit		

Assumed NOMINAL is set to 100mΩ, BIN1~BIN8 set as ±0.1%~±0.8%, please follows the below method to operate:

- (1) Press [F3] key to move the cursor to NOMINAL position, and move the cursor to hundred then press [F1] key to adjust the number to 1. Press [F3] key to move the cursor to (-) position, then press [F1] key to set unit to m.

After the setting is completed the screen should be as below shown:

< BINNING SET >		
	DIGIT UP	F1
NOMINAL : 100.0000mΩ	DIGIT DOWN	F2
	DIGIT	F3
Press down arrow to set bins	VIEW	F4
Press MAIN INDEX to exit		

- (2) Press [F4] key, the screen switched as below shown.

< BINNING SET >				
BIN	HI	LO	DIGIT UP	F1
-----			DIGIT DOWN	F2
1	000.0000 Ω	000.0000 Ω	DIGIT	F3
2	000.0000 Ω	000.0000 Ω		
3	000.0000 Ω	000.0000 Ω		
4	000.0000 Ω	000.0000 Ω		
Press MAIN INDEX to exit			MODE: ABS	F4

← Set the high/low limits are ABS (absolute value) or %(percentage)  
 Notice: The high/low values of percentage and absolute modes can't convert for each other.

- (3) Press [F3] key, the cursor move to the first decimal place of high limit (HI) of BIN 1. Press [F1] key, digit up to 1 and then press [TRIGGER] make low limit (LO) change to – 0.1% by high limit (HI) value. Press [▽] key to move the cursor to BIN2. According to setting method of BIN1 to change BIN2 setting value as ±0.2%, BIN3 and BIN8 are deduced by analogy.

**<<If the values of high limit (HI) and low limit (LO) are not symmetry. Please set high limit (HI) firstly, press [▷] key to move the cursor to LO field and then set low limit (LO).>>**

After the setting is completed the screen as the below shown.

< BINNING SET >				F1
BIN	HI	LO	DIGIT UP	
1	+001.00%	-001.00%	DIGIT DOWN	F2
2	+002.00%	-002.00%	DIGIT	F3
3	+003.00%	-003.00%		F4
4	+004.00%	-004.00%		
Press MAIN INDEX to exit			MODE: %	

< BINNING SET >				F1
BIN	HI	LO	DIGIT UP	
5	+005.00%	-005.00%	DIGIT DOWN	F2
6	+006.00%	-006.00%	DIGIT	F3
7	+007.00%	-007.00%		F4
8	+008.00%	-008.00%		
Press MAIN INDEX to exit			MODE: %	

- After high limit (HI) and low limit (LO) of BIN settings are completed, the screen returns to <BINNING SET>. Meanwhile, press [F4] key (VIEW) to enter HI and LO absolute values of previously setting as below shown.

< BINNING SET >				F1
BIN	HI	LO	DIGIT UP	
5	+005.00%	-005.00%	DIGIT DOWN	F2
6	+006.00%	-006.00%	DIGIT	F3
7	+007.00%	-007.00%		F4
8	+008.00%	-008.00%		
Press MAIN INDEX to exit			MODE: %	

Press [F4] → [MAIN INDEX] key for returning <MAIN INDEX : BINNING> menu.

- After all settings are completed, press [F4] once then enter Binning test screen as below shown.

BIN	COUNT	BIN	COUNT		F1
0	0	5	0	SPEED: F	
1	0	6	0	TRIG : INT .	F2
2	0	7	0		F3
3	0	8	0		F4
4	0	OUT	0		
TOTAL :			0	RESET	

Description: BIN 0 and BIN OUT counters are over high and low limit values in statistical. BIN 1 counter is not over high and low limit values in statistical, and primary parameter is within ± 0.1%. BIN2 ~ 8 are deduced by analogy. RESET: Press [F4] key, all counters are cleared.

## 4.5 Reference Data for Operating

- DC modes (DC+, DC-):  
Only output the test current of a DC level under this mode. Because there is only DC level signal, thus this mode is applicable to rapid measurement of inductance DUT
- Pulse modes (PULSE+, PULSE-, PULSE+/-):  
Thermocouples between various metals in some junctions of wire will result in the effect of Thermoelectric EMFs which is called in electricity. It is inevitable that Thermoelectric



EMFs will affect the measurement result.

- $V_{emf}$  = Thermoelectric EMFs

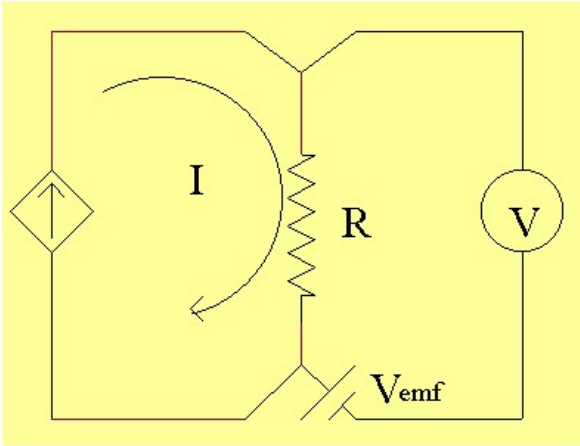

16502 includes pulse mode selections of PULSE+, PLUSE- and PLUSE±. These modes are for avoiding the influence of thermoelectric so that applicable to temperature feature analysis of low resistance measurement and metallic conduction.

- $V_x - V_{emf} = IR$  ,  $V_{emf}$  = Thermoelectric EMFs

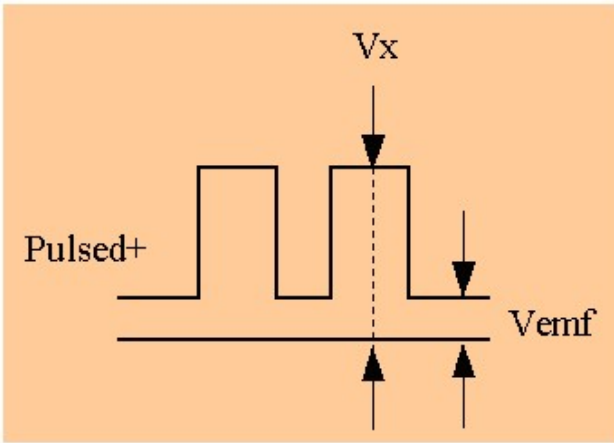

3. DRY Circuit: DRY is to limit level of open voltage for protecting resistance measurement on junctions from damaging the surface caused by the starting over high voltage. The level of 16502 open voltage is limited under 20mV.
4. MEAS. DELAY: It is needed to adjust measurement delay time in component test with large inductance until the test current is stable then to start measuring.

■ Measurement Delay

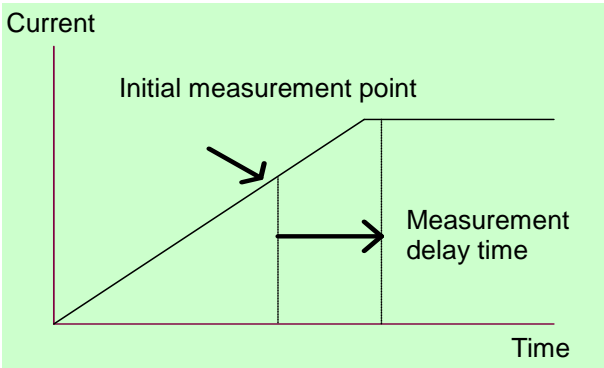



## 5. Descriptions of GPIB Interface (Commands Same as RS232 Interface)

### 5.1 Overview

The meter 16502 can be controlled remotely and is able to perform data transfer function via the IEEE-488.2/RS232 interface.

### 5.2 Specification of IEEE-488 Interface

1. For IEEE-488 interface, it is able to use the commands of 488.1 (compatible with KEITHLEY 5802) and 488.2 interfaces (including common and general commands.) It must be set in 16502 SYSTEM SETUP prior uses.
2. This chapter mainly explains the commands of GPIB interface bus to facilitate users in writing programs to control the 16502 for handling the tested data.

#### 5.2.1 IEEE-488 Interface Function

Code	Meaning
SH1	Source handshake (talker)
AH1	Acceptor handshake (listener)
T4	Basic talker function
L4	Basic listener function
SR1	Device requests service from controller
RL1	Remote/local switch function
PP0	No parallel poll functions
DC1	Device clear function
DT0	Device trigger function
C0	No controller function

#### 5.2.2 Code Used for Data Transfer

The code used for data transfer is the ISO ASCII code.

#### 5.2.3 TALK/LISTEN Function

"TALK/LISTEN" denotes full programmability and is suitable for the controller or computer system with data processing.

## 5.2.4 IEEE-488 Interface Connector

- Below shows the connector pin assignment:

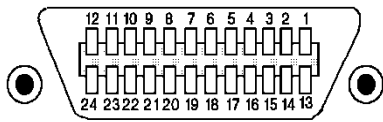

1 DIO1	13 DIO5
2 DIO2	14 DIO6
3 DIO3	15 DIO7
4 DIO4	16 DIO8
5 EOI	17 REN
6 DAV	18 GND
7 NRFD	19 GND
8 NDAC	20 GND
9 IFC	21 GND
10 SRQ	22 GND
11 ATN	23 GND
12 SHIELD	24 GND

- Meter side connector:  
DDK 57 LE-20240 or equivalent.
- Cable side connector:  
DDK 57-10240 or equivalent.

## 5.2.5 Signal Cable of IEEE-488 Interface

The interface is composed of the data, the handshake and the control ports as shown in the table below:

Port	Signal Cable of Port	Description
Data Port	DIO1 (Data Input/Output 1) DIO2 (Data Input/Output 2) DIO3 (Data Input/Output 3) DIO4 (Data Input/Output 4) DIO5 (Data Input/Output 5) DIO6 (Data Input/Output 6) DIO7 (Data Input/Output 7) DIO8 (Data Input/Output 8)	Besides data input, it is also used for interface and device message input/output.
Handshake Port	DAC (Data Valid)	Indicate that the data on the data port are valid.
	NRFD (Not Ready For Data)	Indicate that the listener is ready to receive.
	NDAC (Not Data Accepted)	Indicate that the listener has finished the data reception.
Control Port	ATN (Attention)	Indicate the signal on the data port carries data or message of an interface or device.
	REN (Remote Enable)	Switch between remote and local control mode.
	IFC (Interface Clear)	Used to reset the interface.
	SRQ (Service Request)	Signal sent by talker to call the controller.
	EOI (End of Identification)	Indicate end of data.

## 5.2.6 Port Driver

The specification of port driver is listed below:

DIO1-8 SRQ NRFD NDAC	Open Collector
EOI REN DAV IFC ATN	3 States

## 5.2.7 Response of Interface Message

Interface Message	Meaning	Response
GTL	Go To Local	Be able to switch the instrument to Local state
SDC	Selective Device Clear	Clear GPIB interface state
IFC	Interface Clear	Reset GPIB interface

## 5.3 GPIB Commands Description (IEEE 488.2)

### 5.3.1 Command Structure

Command	Parameter	Return
ABORt		[No query]
CALCulate		
: ALARm		
: CONDition	FAIL   PASS	FAIL   PASS
: MODE	PULSe   CONTinuous	PULS   CONT
: BINNing		
: CLEAR		[No query]
: RESUlT?	[For query only]	<NR1>
: MATH		
: NAME	DEV PCNT	DEV PCNT
: BIN{1 2 3 4 5 6 7 8}		
: UPPer	<NRf+> {Suffix Unit}	<NR2> Suffix Unit
: LOWer	<NRf+> {Suffix Unit}	<NR2> Suffix Unit
: NOMInal	<NRf+> {Suffix Unit}	<NR2> Suffix Unit
: STATe	<Boolean>	<NR1>
: COMPare		

: CLEAR : RESULT? : MATH : EXPRESSION : CATALOG? : NAME : STATE : LIMIT : STATE : NOMINAL : LOWER : UPPER	[For query only] [For query only] DEV PCNT <Boolean> <Boolean> <NRf+> {Suffix Unit} <NRf+> {Suffix Unit} <NRf+> {Suffix Unit}	[No query] <NR1> <NR3> DEV PCNT <NR1> <NR1> <NR2> Suffix Unit <NR2> Suffix Unit <NR2> Suffix Unit
TEMPERATURE :UNIT :ATEMP :MODE :INITIAL [:CURRENT] :RESISTANCE [:INITIAL]	DEGC DEGF OFF AUTO MAN <NRf+> <NRf+> <NRf+> {Suffix Unit}	DEGC DEGF OFF AUTO MAN <NR2> <NR2> <NR2> Suffix Unit
:CONSTANT :CORRECT :TCOEFF :CONVERSION :MODE [:RESULT]? :PROBE	<NRf+> <NRf+> <NR1> ABS DEV 0 1  [For query only] 0 1	<NR2> <NR2> <NR1> {ABS DEV} <NR2> <NR1>
RSCAN :LIMIT : NOMINAL :STEP : MATH : NAME :STEP{1 2 3} :UPPER :LOWER :BL : MATH : NAME :UPPER :TEST :STEP{1 2 3} :PIN :MEASURE :STEP{1 2 3} :RESULT? :BL :RESULT? :RESULT?	<NRf+> {Suffix Unit} DEV PCNT <NRf+> {Suffix Unit} <NRf+> {Suffix Unit} DEV PCNT <NRf+> {Suffix Unit} <NR1> [For query only] [For query only] [For query only] [For query only]	<NR2> Suffix Unit DEV PCNT <NR2> Suffix Unit <NR2> Suffix Unit DEV PCNT <NR2> Suffix Unit <NR1> <NR3> <NR1> <NR3> <NR1> <NR1>

SENSE : AVERAGE : COUNT : ZERO : STATE : DATA? : RANG : AUTO : SPEED	<NR1>  <Boolean> [For query only] <NR1>   MIN   MAX} <Boolean> MAX   VFAST   FAST   MEDlum   SLOW	<NR1>  <NR1> <NR3> <NR1> <NR1> MAX   V.FAST   FAST   MEDI  SLOW
SOURCE : DRY  : DRIVE	<Boolean> {0 (PULSE+/- )   1(PULSE+)  2(PULSE -)   3(DC+)  4( DC -)   5(DC+ NA)   6 (STBY)}	<NR1>  <NR1>
READ	[For query only]	<NR3>
TRIGGER : SOURCE : DELAY : EDGE : [IMMEDIATE]	INTERNAL MANual EXTernal B US SMT <NR1> FALLing   RISIng	INT MAN BUS   EXT   SMT <NR1> FALL   RISI
STATUS : OPERATION : EVENT? : ENABLE : PRESET	[For query only] <NR1>	<NR1> <NR1> [No query]
SYSTEM : BEEPER [: IMMEDIATE] : MODE : MDELAY : LFRQUENCY : HANDLER : CONTRAST : KLOCK : PRESET : ERROR? : LOCAL : COMPDISP : PADDR [: OFFSET]	LARGE   SMALL   OFF <NR2> 50   60 CLEAR   HOLD <NR1> <Boolean> [For query only] <Boolean> <NRf+>	LARGE   SMALL   OFF <NR3> 50   60 CLEAR  HOLD <NR1> 0   1 [No query] <NR1>,"<string>" 0   1 <NR2>

### 5.3.2 Description of Command Structure

The top of the command tree structure is Root. There are six levels from top to bottom. To give a certain level of command, it is necessary to follow the specific path to access it. For example, it is required to state the whole path to give the command of LOWER as shown below.

Ex. :CALCulate:COMPare:LIMit:LOWer 3.12E2

In addition, to give two commands at the same time (ex. to set or query ZERO ON and OFFSet), use the following method to simplify the command.

:SENSe:ZERO:STATe ON;DATA?

It is same as the following two commands below, but simpler.

:SENSe:ZERO:STATe ON  
:SENSe:ZERO:STATe:DATA?

Colon (:) is required to separate the command between levels and the first colon at the beginning of each command line indicates the Root. Also two commands need to be separated by semicolon (;) in one command line. For example:

Ex. :SENSe:ZERO:STATe ON;:SOURce:DRY ON

It means the same as the following two command lines.

:SENSe:ZERO:STATe ON  
:SOURce:DRY ON

The colon after a semicolon indicates the Root. If the command is available for setting and query, add a parameter to the command when setting it and add a question mark "?" to it when query is required.

:SENSe:ZERO:STATe?

The lower case letter and the text in [ ] in the command indicates they can be omitted.

**Data Transmitting Format:**

The data will be transmitted by ASCII byte along with the formats of <NR1> (integral format), <NR2> (fixed decimal format) and <NR3> (floating number format). The data are separated by comma (the standard of IEEE-488.2). The format descriptions are as follows.

(1) <NR1> format:

Ex.: 9000

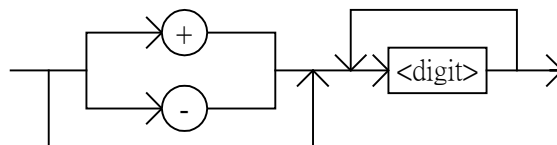

(2) <NR2> format:

Ex.: 9000.0

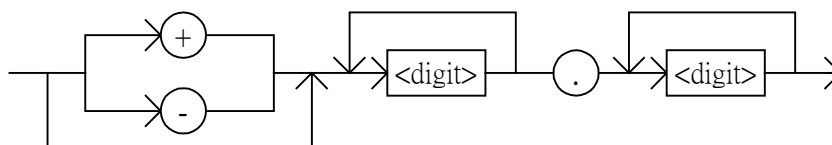



(3) <NR3> format:

Ex.: 9.0E+3

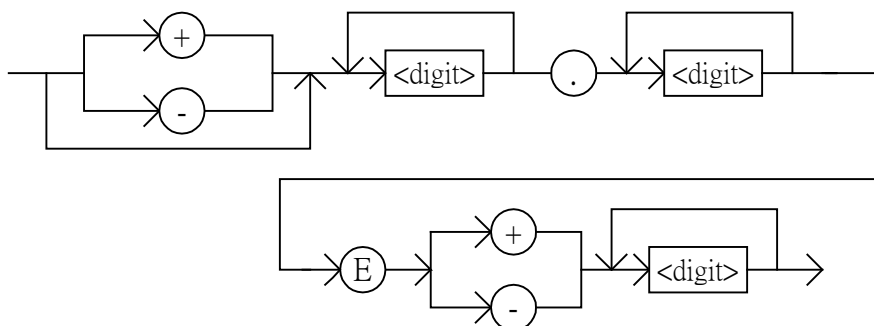

### 5.3.3 Command Description

#### ◆ ABORt Command

Command: ABORt

Parameter: None

Return: None

Function: It aborts the measurement in executing immediately.

#### ◆ CALCulate Command Set

(1) Command: CALCulate:ALARm:CONDition { FAIL | PASS}

Function: It defines the alarm output.

Parameter: FAIL The alarm enables when the comparison result is FAIL.

PASS The alarm enables when the comparison result is PASS.

Return: The query returns FAIL or PASS.

(2) Command: CALCulate:ALARm:MODE { PULSe | CONTInuous }

Function: It sets or queries the beeper's action in comparison function.

Parameter: PULSe It beeps with pulse.

CONTInuous It beeps continuously.

Return: The query returns PULS or CONT.

(3) Command: CALCulate:BINNING:CLEAr

Function: It clears STBY state of BIN test result.

Parameter: None

Return: None

(4) Command: CALCulate:BINNING:RESUlt?

Function: It returns BIN SORT result.

Parameter: None

Return: The query returns <NR1> +0~+9,+11,

+0 BINNING OFF or bin sort result is LO.

+1 ~ +8 BINNING sort result.

+9 Bin sort result is HI.

+10 Bin sort result is OUT.

+11 STBY state

(5) Command: CALCulate:BINNING:MATH:NAME { DEV|PCNT}

Function: It sets or queries the expression of value.

Parameter: DEV indicates the expression is absolute value.

PCNT indicates the expression is percentage value.

- Return: The query returns DEV or PCNT.
- (6) Command: CALCulate:BINning:BIN(1~8):UPPer <NRf+> {Suffix Unit}  
Function: It sets or queries the high limit of BIN.  
Parameter: <NRf> | MINimum | MAXimum parameter is acceptable.  
DEV parameter range: 0.0000 MOHM(MIN) ~ 200.0000 MAOHM(MAX).  
PERCENT parameter range: 0.00(MIN) ~ 999.99(MAX).  
Unit: The units of parameter are {MOHM | OHM | KOHM | MAOHM} when  
CALCulate:BINning:MATH:NAME is set to DEV. If there is no giving unit, OHM  
will be defined automatically. Interval between paramter and unit is by blank.  
Ex.: CALCulate:BINning:BIN1:UPPer 101.000 KOHM  
If CALCulate:BINning:MATH:NAME setting is PCNT, there is no parameter unit.  
Return: The query returns <NR2> suffix unit. Ex.: 101.000 KOHM or 100.00 %.
- (7) Command: CALCulate:BINning:BIN(1~8):LOWer <NRf+> {Suffix Unit}  
Function: It sets or queries the low limit of BIN.  
Parameter: <NRf> | MINimum | MAXimum parameter is acceptable.  
DEV parameter range: 0.0000 MOHM(MIN) ~ 200.0000 MAOHM(MAX)  
PERCENT parameter range: 0.00(MIN) ~ 999.99(MAX).  
Unit: The units of parameter are {MOHM | OHM | KOHM | MAOHM} when  
CALCulate:BINning:MATH:NAME is set to DEV. If there is no giving unit, OHM  
will be defined automatically. Interval between paramter and unit is by blank.  
Ex.: CALCulate:BINning:BIN1:LOWer 99.000 KOHM  
If CALCulate:BINning:MATH:NAME setting is PCNT, there is no parameter unit.  
Return: The query returns <NR2> suffix unit. Ex.: 99.000 KOHM or 100.00 %.
- (8) Command: CALCulate:BINning:NOMInal{<numeric\_value|MIN|MAX} [Suffix Unit]  
Function: It sets or queries nominal of BIN SORT.  
Parameter: <NRf> | MINimum | MAXimum parameter is acceptable.  
Parameter range: 0.0000 MOHM(MIN) ~ 200.0000 MAOHM(MAX)  
Unit: It defines unit of setting parameter {MOHM | OHM | KOHM | MAOHM}, if no  
the command of unit, OHM will be defined automatically. Interval between  
paramter and units is by blank.  
Ex.: CALCulate:BINning:NOMInal 100.000 MOHM  
Return: The query returns <NR2> with suffix unit.  
Ex.: 100.0000 KOHM
- (9) Command: CALCulate:BINning:STATe {OFF | ON | 0 | 1 }  
Function: It sets or queries if BINNING function is enabled.  
Parameter: OFF (0)     Disable BINNING function  
            ON (1)     Enable BINNING function  
Return: The query returns 0 or 1.
- (10) Command: CALCulate:COMPare:CLEAr  
Function: It clears STBY state of comparison result.  
Parameter: None  
Return: None
- (11) Command: CALCulate:COMPare:RESUlt?  
Function: It returns comparison result.  
Parameter: None  
Return: The query returns <NR1> +0 ~ +11,  
          +0     COMPARE OFF or comparison result is LO.  
          +9     Comparsion result is HI.  
          +10    Comparsion result is PASS.  
          +11    STBY state
- (12) Command: CALCulate:COMPare:MATH:EXPRession:CATalog?

- Function: It returns numeric value after mathematics by setting (CALCulate:COMPare:MATH:EXPRession:NAME)  
Parameter: None  
Return: The query returns <NR3>.
- (13) Command: CALCulate:COMPare:MATH:EXPRession:NAME {DEV|PCNT}  
Function: It sets or queries the expression of numeric value.  
Parameter: DEV The expression of numeric value is absolute value.  
PCNT The expression of numeric value is percentage value.  
Return: The query returns DEV or PCNT.
- (14) Command: CALCulate:COMPare:MATH:STATe {OFF | ON | 0 | 1}  
Function: It sets or queries CALCulate:COMPare:MATH:EXPRession:NAME definition in mathematics process.  
Parameter: ON (1) Enable mathematics process.  
OFF(0) Disable mathematics process.  
Return: The query returns 0 or 1.
- (15) Command: CALCulate:COMPare:LIMit:STATe {OFF | ON | 0 | 1}  
Function: It sets or queries comparison function is enabled.  
Parameter: OFF (0) Disable comparison function.  
ON (1) Enable comparison function.  
Return: The query returns <NR1> 0 or 1.
- (16) Command: CALCulate:COMPare:LIMit:NOMInal <NRf+> {Suffix Unit}  
Function: It sets or queries nominal of comparison function.  
Parameter: <NRf> | MINimum | MAXimum parameter is acceptable.  
Parameter range: 0.0000 MOHM(MIN) ~ 200.0000 MAOHM(MAX)  
Unit: It defines unit of parameter {MOHM | OHM | KOHM | MAOHM}, if no the command of unit, OHM will be defined automatically. Interval between paramter and units is by blank.  
Ex.: CALCulate:COMPare:LIMit:NOMInal 100.000 KOHM  
Return: The query returns <NR2> with suffix unit.  
Ex.: 100.0000 KOHM
- (17) Command: CALCulate:COMPare:LIMit:LOWer <NRf+> {Suffix Unit}  
Function: It sets or queries the low limit of comparison function.  
Parameter: <NRf> | MINimum | MAXimum parameter is acceptable.  
DEV parameter range: 0.0000 MOHM(MIN) ~ 200.0000 MAOHM(MAX)  
PERCENT parameter range: 0.00(MIN) ~ 999.99(MAX)  
Unit: The units of parameter are {MOHM | OHM | KOHM | MAOHM} when CALCulate:COMPare:MATH:EXPRession:NAME is set to DEV. If there is no giving unit, OHM will be defined automatically. Interval between paramter and unit is by blank.  
Ex.: CALCulate:COMPare:LIMit:LOWer 99.000 KOHM  
If CALCulate:COMPare:MATH:EXPRession:NAME setting is PCNT, there is no parameter unit.  
Return: The query returns <NR2> with suffix unit.  
Ex.: 99.000 KOHM or 100.00 %.
- (18) Command: CALCulate:COMPare:LIMit:UPPer <NRf+> {Suffix Unit}  
Function: It sets or queries the high limit of comparison function.  
Parameter: <NRf> | MINimum | MAXimum parameter is acceptable.  
DEV parameter range: 0.0000 MOHM(MIN) ~ 200.0000 MAOHM(MAX).  
PERCENT parameter range: 0.00(MIN) ~ 999.99(MAX).  
Unit: The units of parameter are {MOHM | OHM | KOHM | MAOHM} when CALCulate:COMPare:MATH:EXPRession:NAME is set to DEV. If there is no

giving unit, OHM will be defined automatically. Interval between parameter and unit is by blank.

Ex.: CALCulate:COMPare:LIMit: UPPer 101.000 KOHM

If CALCulate:COMPare:MATH:EXpression:NAME setting is PCNT, there is no parameter unit.

Return: The query returns <NR2> with suffix unit.

Ex.: 101.0000 KOHM

#### ◆ TEMPerature Command Set

- (1) Command: TEMPerature: UNIT {DEGC|DEGF}

Function: It sets or queries the unit of temperature value.

Parameter: DEGC : °C, DEGF: °F

Return: The query returns DEGC or DEGF.

- (2) Command: TEMPerature:ATEMP:MODE {OFF|AUTO|MAN}

Function: It sets ambient temperature mode of conversion and correction functions.

Parameter: OFF means temperature correction doesn't be executed under correction function as well as the current ambient temperature equals to the initial temp. setting under conversion function.

AUTO means measuring the current ambient temperature by 16502 optional tester. (If there is no optional device, thus AUTO mode is disabled.)

MAN means inputting the current ambient temperature by users.

Return: The query returns OFF, AUTO or MAN.

- (3) Command: TEMPerature:ATEMP:INITial <NRf+>

Function: It sets or queries the initial temperature value of conversion function.

Parameter: <NR2> | MINimum | MAXimum parameter is acceptable.

TEMPerature: When UNIT is DEGC, the value setting range -10(MIN) ~ 99.9(MAX).

TEMPerature: When UNIT is DEGF, the value setting range 14(MIN) ~ 211.8(MAX).

Return: The query returns <NR2> Ex.: +25.0.

- (4) Command: TEMPerature:ATEMP[:CURRent] <NRf+>

Function: It sets or queries the current ambient temperature.

Parameter: When TEMPerature:ATEMP:MODE is MAN for setting the current ambient temperature value. <NR2> | MINimum | MAXimum parameter is acceptable.

TEMPerature: When UNIT is DEGC, the value setting range -10(MIN) ~ 99.9(MAX).

TEMPerature: When UNIT is DEGF, the value setting range 14(MIN) ~ 211.8(MAX).

Return: The query returns <NR2>. Ex.: +25.0.

- (5) Command: TEMPerature:RESistance[:INITial] <NRf+> {Suffix Unit}

Function: It sets or queries DUT's resistance under initial temperature of conversion function.

Parameter: <NRf+> | MINimum | MAXimum parameter is acceptable.

Parameter range: 0.0000 MOHM(MIN) ~ 999.999 MAOHM(MAX)

Unit: It defines the unit of setting parameter {MOHM | OHM | KOHM | MAOHM}, if there is no command of unit, OHM will be defined automatically. Interval between parameter and units is by blank.

Ex.: TEMPerature:RESistance:INITial 101.000 KOHM

Return: The query returns <NR2> with suffix unit. Ex.: 101.0000 KOHM.

- (6) Command: TEMPerature:CONStant <NRf+>

Function: It sets or queries the coefficient of temperature conversion function.

Parameter: <NR2> | MINimum | MAXimum parameter is acceptable.

Range: 0.0(MIN) ~99.9(MAX)

Return: The query returns <NR2>.

- (7) Command: TEMPerature:CORRect <NRf+>

Function: It sets or queries the reference temperature of correction function.

Parameter: <NR2> | MINimum | MAXimum parameter is acceptable.

TEMPerature: When UNIT is DEGC, the value setting range -10(MIN) ~ 99.9(MAX).

TEMPerature: When UNIT is DEGF, the value setting range 14(MIN) ~ 211.8(MAX).

Return: The query returns <NR2>. Ex.: +25.0.

- (8) Command: TEMPerature:TCOEf <NRf+>

Function: It sets or queries thermal coefficient parameter of correction function.

Parameter: <NR1> | MINimum | MAXimum parameter is acceptable.

Range 1(MIN) ~9999(MAX)

Return: The query returns <NR1>.

- (9) Command: TEMPerature:CONVersion:MODE { ABS|DEV|0|1}

Function: It sets the temperature display mode of conversion function.

Parameter: ABS or 0 The temperature of conversion displays T.

DEV or 1 The temperature of conversion displays  $\Delta T$ .

Return: The query returns ABS or DEV.

- (10) Command: TEMPerature:CONVersion[:RESUlt]?

Function: It queries the temperature value of conversion.

Parameter: None

Return: The query returns <NR3>.

- (11) Command: TEMPerature:PROBE {0|1}

Function: It sets temperature probe type.

Parameter: 0 PT100

1 PT500

#### ◆ RSCAN Command Set

- (1) Command: RSCAN:LIMit:NOMInal <NRf+> {Suffix Unit}

Function: It sets or queries nominal value of RSCAN function STEP and BL parameter.

Parameter: <NRf> | MINimum | MAXimum parameter is acceptable.

Parameter range: 0.0000 MOHM(MIN) ~ 200.0000 MAOHM(MAX).

Unit: It defines the unit of setting parameter {MOHM | OHM | KOHM | MAOHM}, if there is no giving unit, OHM will be defined automatically. Interval between parameter and unit is by blank.

Ex.: RSCAN:LIMit:NOMInal 100.000 KOHM

Return: The query returns <NR2> with suffix unit. Ex.: 100.0000 KOHM.

- (2) Command: RSCAN:LIMit:STEP:MATH:NAME {DEV |PCNT}

Function: It sets or queries upper/lower limit setting value expression for STEP1~3.

Parameter: DEV indicates the expression is absolute value.

PCNT indicates the expression is percentage value.

Return: The query returns DEV or PCNT.

- (3) Command: RSCAN:LIMit:STEP{1|2|3}:UPPer <NRf+> {Suffix Unit}

Function: It sets or queries the upper limit for STEP1~3.

Parameter: <NRf> | MINimum | MAXimum parameter is acceptable.

DEV parameter range: 0.0000 MOHM(MIN) ~ 200.0000 MAOHM(MAX).

PERCENT parameter range: 0.00(MIN) ~ 999.99(MAX).

Unit: The units of parameter can be set to {MOHM | OHM | KOHM | MAOHM} when RSCAN:LIMit:STEP:MATH:NAME is set to DEV. If there is no giving unit, OHM will be defined automatically. Interval between parameter and unit is by blank.

Ex.: RSCAN:LIMit:STEP1:UPPer 101.000 KOHM

When RSCAN:LIMit:STEP:MATH:NAME setting is PCNT, there is no parameter unit.

Return: The query returns <NR2> with suffix unit. Ex.: 101.000 KOHM or 100.00 %.

- (4) Command: RSCAN:LIMit:STEP{1|2|3}:LOWer <NRf+> {Suffix Unit}

Function: It sets or queries the lower limit for STEP1~3.

Parameter: <NRf> | MINimum | MAXimum parameter is acceptable.

DEV parameter range: 0.0000 MOHM(MIN) ~ 200.0000 MAOHM(MAX)

PERCENT parameter range: 0.00(MIN) ~ 999.99(MAX)

Unit: The units of parameter can set to {MOHM | OHM | KOHM | MAOHM} when RSCAN:LIMit:STEP:MATH:NAME is set to DEV. If there is no giving unit, OHM will be defined automatically. Interval between parameter and unit is by blank.

Ex.: RSCAN:LIMit:STEP1:LOWer 100.000 KOHM

If RSCAN:LIMit:STEP:MATH:NAME setting is PCNT, there is no parameter unit.

Return: The query returns <NR2> with suffix unit. EX.: 100.000 KOHM or 100.00 %.

- (5) Command: RSCAN:LIMit:BL:MATH:NAME {DEV |PCNT}

Function: It sets or queries BL upper/lower limit setting expression.

Parameter: DEV indicates the expression is absolute value.

PCNT indicates the expression is percentage value.

Return: The query returns DEV or PCNT.

- (6) Command: RSCAN:LIMit:BL:UPPer <NRf+> {Suffix Unit}

Function: It sets or queries BL upper limit.

Parameter: <NRf> | MINimum | MAXimum parameter is acceptable.

DEV parameter range: 0.0000 MOHM(MIN) ~ 200.0000 MAOHM(MAX)

PERCENT parameter range: 0.00(MIN) ~ 999.99(MAX)

Unit: The units of parameter can set to {MOHM | OHM | KOHM | MAOHM} when RSCAN:LIMit:BL:MATH:NAME is set to DEV. If there is no giving unit, OHM will be defined automatically. Interval between parameter and unit is by blank.

Ex.: RSCAN:LIMit:BL:UPPer 100.000 KOHM

If RSCAN:LIMit:BL:MATH:NAME setting is PCNT, there is no parameter unit.

Return: The query returns <NR2> with suffix unit. Ex.: 100.000 KOHM or 100.00 %.

- (7) Command: RSCAN:TEST:STEP{1|2|3}:PIN <numeric\_value>

Function: It sets or queries test pin for STEP1~3.

Parameter: numeric\_value 0~6

0: 0-0(indicates STEP no testing)

1:1-4

2:2-4

3:3-4

4:1-2

5:2-3

6:1-3

Return: numeric\_value0~6

- (8) Command: RSCAN:MEASure:STEP{1|2|3}?

Function: It queries measurement resistance for STEP1~3.

Parameter: None

Return: The query returns <NR3>.

- (9) Command: RSCAN:MEASure:STEP{1|2|3}:RESUlt?

Function: It queries measurement result for STEP1~3.



Parameter: None

Return: The query returns <NR1>. 0, 9, 10, 11.

0 measurement result is LO.

9 measurement result is HI.

10 measurement result is GO.

11 is in STBY status not process measurement.

(10) Command: RSCAN:MEASure:BL?

Function: It queries BL value.

Parameter: None

Return: The query returns <NR3>.

(11) Command: RSCAN:MEASure:BL:RESUlt?

Function: It queries BL measurement result.

Parameter: None

Return: The query returns <NR1>, 9, 10, 11.

9 measurement result is HI.

10 measurement result is GO.

11 is in STBY status not process measurement.

(12) Command: RSCAN:MEASure:RESUlt?

Function: It queries measurement result.

Parameter: None

Return: The query returns <NR1> 9, 10, 11.

9 measurement result is FAIL.

10 measurement result is PASS.

11 is in STBY status not process measurement.

#### ◆ SENSE Command Set

(1) Command: SENSE:AVERage:COUNT < NR1>

Function: It sets or queries average of measuring.

Parameter: <NR1> 1 ~ 10

Return: <NR1> 1 ~ 10

(2) Command: SENSE:ZERO:STATe { OFF | ON | 0 | 1 }

Function: It sets or queries calculation function of ZERO.

Parameter: OFF(0) Disable calculation function of ZERO.

ON(1) Enable calculation function of ZERO.

Return: The query returns 0 or 1.

(3) Command: SENSE:ZERO:DATA?

Function: It queries calculation function of ZERO.

Parameter: None

Return: The query returns <NR3>.

(4) Command: SENSE:RANG<NRf+>

Function: It sets or queries the measurement range. When Dry Circuit Test is enabled, the range is not in allowed range. The range isn't change and Error displayed.

Parameter: <NR1> | MINimum | MAXimum parameter is acceptable. Parameter range  
0(20mΩ)|1(200mΩ)|2(2Ω)|3(20Ω)|4(200Ω)|5(2KΩ)|6(20KΩ)|7(200KΩ)|  
8(2MΩ)

Return: The query returns <NR1> 0~8.

(5) Command: SENSE:RANG:AUTO {OFF | ON | 0 | 1}

Function: It sets or queries if auto range is enabled.

Parameter: OFF (0) Select the range manually.

ON (1) Select the range automatically.

Return: The query returns <NR1> 0 or 1.

(6) Command: SENSE:SPEEd { MAX|VFAST|FAST|MEDIUm | SLOW}

Function: It sets or queries the measurement speed.

Parameter: MAX           The measurement speed is maximum speed.  
           VFAST         The measurement speed is very fast.  
           FAST          The measurement speed is fast.  
           MEDIUM       The measurement speed is medium.  
           SLOW          The measurement speed is slow.

Return: The query returns in the format of string is as MAX, V.FAST, FAST, MEDI or SLOW.

#### ◆ SOURce Command Set

(1) Command: SOURce:DRY {OFF | ON | 0 | 1}

Function: It sets or queries Dry Circuit Test is enabled.

Parameter: OFF (0)    Disable the Dry Circuit Test mode.  
           ON (1)      Enable the Dry Circuit Test mode.

Return: The query returns <NR1> 0 or 1.

(2) Command: SOURce:DRive { 0(PULSE+/-) | 1(PULSE +) | 2(PULSE-) | 3(DC +) | 4(DC -) | 5(DC+ NA) | 6(STBY)}

Function: It sets or queries the mode of DRIVE.

Parameter: 0    is the PULSE +/- mode.  
           1    is the PULSE + mode.  
           2    is the PULSE- mode.  
           3    is the DC+ mode.  
           4    is the DC- mode.  
           5    is the DC+ NA mode.  
           6    is the Stand By mode.

Return: The query returns <NR1> 0~6.

#### ◆ READ Command Set

(1) Command: READ?

Function: It queries the measurement result at present. If the command of measurement (TRIGger or \*TRG) is not executed, a return invalid value will be produced at the same time as well as an error message ("Data stale") also is produced.

Parameter: None

Return: The query returns <NR3>.

#### ◆ TRIGger Command Set

(1) Command: TRIGger:SOURce {INTernal|MANual|EXTernal|BUS|SMT}

Return: {BUS|EXTernal|INTernal|MANual}

Function: It sets or queries the trigger mode at present.

Parameter: INTernal    Internal continuous trigger  
           MANual       Manual trigger  
           EXTernal     External trigger mode.  
           BUS          BUS trigger mode.  
           SMT          SMART trigger

Parameter: The query returns INT|MAN |EXT|BUS|SMT

(2) Command: TRIGger:DELay <NR1>

Function: It sets or queries the time delayed for trigger, the range is 0 ~ 999ms.

Parameter: Acceptable <NR1>

Return: <NR1>



- (3) Command: TRIGger:EDGE {FALLing|RISIng}  
Function: It sets or queries the selection of falling and rising trigger.  
Parameter: FALLing Falling trigger  
            RISIng Rising trigger  
Return: The query returns FALL|RISl.
- (4) Command: TRIGger[:IMMediate]  
Function: Whatever the measurement status at present to trigger for measuring.  
Parameter: None  
Return: None

#### ◆ STATUS Command Set

- (1) Command: STATUs:OPERation:EVENT?  
Function: It returns the text of event register of operation status group.  
Parameter: None  
Return: The query returns <NR1>.
- (2) Command: STATUs:OPERation:ENABle <NR1>  
Function: It sets or queries the enable register comment of operation status group.  
Parameter: The decimal expression of register text is <NR1>0~255.  
Return: The query returns <NR1>.
- (3) Command: STATUs:PRESet  
Function: It clears the event register of operation status group as well as enables the text of register.  
Parameter: None  
Return: None

#### ◆ SYSTEM Command Set

- (1) Command: SYSTem:BEEPer[:IMMediate]  
Function: The beeper beeps at once.  
Parameter: None  
Return: None
- (2) Command: SYSTem:BEEPer:MODE {LARGe | SMAlI | OFF}  
Function: It sets or queries if the beeper is enabled.  
Parameter: LARGe Enable the beeper in LARGE volume mode.  
            SMAlI Enable the beeper in SMALL volume mode.  
            OFF Disable all beepers including error beeps.  
Return: The query returns LARGE, SMALL or OFF.
- (3) Command: SYSTem:MDELay <NR2>  
Function: It sets or queries the time delayed for measurement.  
Parameter: <NR2> 0.000S ~ 100.0S  
Return: The query returns <NR3>.
- (4) Command: SYSTem:LFRrequency {50 | 60}  
Function: It sets or queries the operating frequency of 16502.  
Parameter: 50 indicates the frequency is 50Hz.  
            60 indicates the frequency is 60Hz.  
Return: The query returns 50 or 60.
- (5) Command: SYSTem:HANDler {CLEAR|HOLD}  
Function: It sets or queries the HANDLER state.  
Parameter: CLEAR It clears the previous test result before executing measurement.  
            HOLD It holds the test result and change until different result appears.

Return: The query returns CLEAR or HOLD.

- (6) Command: SYSTem:CONTRast < NR1>  
 Function: It sets or queries the contrast of LCD.  
 Parameter: <NR1> 0 ~ 15  
 Return: The query returns a numeric value in the format NR1.
- (7) Command: SYSTem:KLOCK {ON(1)|OFF(0)}  
 Function: It sets or queries if the key of 16502 is locked.  
 Parameter: {ON(1)|OFF(0)}  
 Return: The query returns <NR1> 0 or 1.
- (8) Command: SYSTem:PRESet  
 Function: It resets the 16502 to its default state.  
 Parameter: None  
 Return: None

The default state is as below table.

Item	Default Value	:SYST:PRES	*RST	Saved Position
DRIVE	PULSE+/-	PULSE+/-	Saved value	EEPROM
DRY	OFF	OFF	Saved value	EEPROM
TRIG	INT	Not be influenced	Not be influenced	EEPROM
RANGE MODE	AUTO	AUTO	Saved value	EEPROM
RANGE	2M	2M	Saved value	EEPROM
SPEED	FAST	FAST	Saved value	EEPROM
ZERO	OFF	OFF	Saved value	EEPROM
COMPARE	OFF	OFF	Saved value	EEPROM
BINNING	OFF	OFF	Saved value	EEPROM
TEMP.	OFF	OFF	Saved value	EEPROM
NUDCNA	OFF	OFF	OFF	-
The nominal setting of comparator	0.000	0.000	Saved value	EEPROM
The high limit setting of comparator	0.000	0.000	Saved value	EEPROM
The low limit setting of comparator	0.000	0.000	Saved value	EEPROM
The showing mode setting of comparator	ABS	ABS	Saved value	EEPROM
The bin sort parameter	0.0000	0.0000	Saved value	EEPROM
Temp digit unit	°C	°C	Saved value	EEPROM
The initial resistance of temp conversion	1Ω	1Ω	Saved value	EEPROM

The initial temp of temp conversion	20°C	20°C	Saved value	EEPROM
Resistance zero temp coefficient of temp conversion	235	235	Saved value	EEPROM
R SCAN function measurement pin	1-4 2-4 3-4	1-4 2-4 3-4	Saved value	EEPROM
R SCAN function comparator parameter	0.000	0.000	Saved value	EEPROM
AVERAGE TIME	1	1	Saved value	EEPROM
BEEPER	HIGH	HIGH	Saved value	EEPROM
KEY LOCK	OFF	Not be influenced	Not be influenced	EEPROM
CONTRAST	7	7	Saved value	EEPROM
SOUND MODE	FAIL	FAIL	Saved value	EEPROM
ALARM MODE	PULSE	PULSE	Saved value	EEPROM
TRIG DELAY	0mS	0mS	Saved value	EEPROM
TRIG EDGE	FALLING	FALLING	Saved value	EEPROM
HANDLER MODE	CLEAR	CLEAR	Saved value	EEPROM
MEAS. DELAY	0.000S	0.000S	Saved value	EEPROM
LINE FREQ.	60Hz	Not be influenced	Saved value	EEPROM
GPIB ADDRESS	17	Not be influenced	Not be influenced	EEPROM
BAUDRATE	19200	Not be influenced	Not be influenced	EEPROM
CORREC.TEMP	20°C	20°C	Saved value	EEPROM
THERM.COEFF	3930	3930	Saved value	EEPROM
TEMP. PROBE	PT100	PT100	Saved value	EEPROM
AUTO REPORT	OFF	OFF	Saved value	EEPROM
COMP. DISP	ON	ON	Saved value	EEPROM
PADR OFFSET	0.0 mΩ	0.0 mΩ	Saved value	EEPROM

(9) Command: SYSTem: ERRor?

Function: It queries the error number or message in the error queue of 16502.

Parameter: None

Return: numeric\_value    The error message number.

- string                      The error message string containing 80 characters max.
- (10) Command: SYSTem:LOCAl  
Function: It releases 16502 REMOTE status.  
Parameter: None  
Return: None
- (11) Command: SYSTem:PADR[:OFFSet] <NRf+>  
Function: It sets or queries PADR OFFSET, the unit is in MOHM.  
Parameter: <NRf+> | MINimum | MAXimum parameter is acceptable. Range:  
              -50.0(MIN) ~+50.0(MAX)  
Return: The query returns <NR2>, the unit is in MOHM.
- (12) Command: SYSTem:COMPDISP {OFF | ON | 0 | 1}  
Function: It sets or queries test function screen (MEAS DISPLAY) comparator  
              result(HI/PASS/LO) enable or disable display.  
Parameter: {ON(1)|OFF(0)}  
Return: The query returns <NR1> 0 or 1.

## Error Messages

Read error queue from remote interface:  
SYSTem:ERRor?

Below is the format of error message (maximum 80 characters for an error string):  
-102 "Syntax error"

### ◆ Execution Error

- 0            No error  
              There is no error message exist at present.
- 102        Syntax error  
              Invalid character exists in the command string, ex. SOUR:DRIVE,1
- 104        Data Type error  
              The parameter is not defined in the command string.
- 106        Illegal parameter value  
              The parameter type is error in the command string.
- 202        Setting conflict  
              Ex. 1: Sending out \*TRG or TRIGGER command when the trigger mode is external.  
              Ex. 2: Sending out \*TRG or TRIGGER command when DRIVE=STBY.
- 203        Data out of range  
              The data parameter exceeds the valid range, ex. SOUR:DRIVE 8
- 211        Data stale  
              Invalid data  
              Ex.: Receiving READ? command when DRIVE=STBY.
- 224        Self-test failed  
              The self-test executed via remote interface (\*TST) is failed. In addition, there are  
              other test errors. Refer to \*TST? command for the description of return format.
- 225        Too many errors  
              More than 20 errors are occurred and the error queue is full. It will not store other  
              errors until some of them are deleted. The error queue will be cleared after powered  
              off or executing \*CLS (clear state) command.
- 226        Query INTERRUPTED  
              When the device is in sending data state, the sending data is interrupted due to device  
              change to receiving state after got the new command. The output buffer will be cleared.

### 5.3.4 Common Use Commands

- (1) The syntax of common use commands  
The GPIB commands for 16502 are divided into general commands (as listed above) and common use commands. The general commands are in tree structure, while the common use commands have no such structure and can be given in the following format no matter which level it is on:  
\* RST
- (2) Either upper or lower case is ok for the letters.
- (3) A star "\*" has to be the leading character of each command.
- (4) End of Character  
There three types of end of character: [CARRIAGE RETURN] (0Dh), [NEW LINE](0Ah) and [CARRIAGE RETURN](0Dh) + [NEW LINE](0Ah).

Command	Description										
IDN?	It queries the identification string of 4 columns (separated by comma.) They are manufacturer's name, model number, serial number and firmware version in order as well as attached with 0 at last. Typically, return the ID string "Chroma, 16502, AAR165020042, 1.21,0"										
*RST	Initialization 16502 parameter is the power-on status. TRIG, KEYLOCK,GPIBADDRESS, BAUDRATE, etc parameters are not influenced.										
*TST?	It runs self-test and returns the test result summary of errors. Return: <table border="1" style="margin-left: 40px;"> <tr> <td>No Error</td> <td>0</td> </tr> <tr> <td>CPLD</td> <td>1</td> </tr> <tr> <td>EEPROM</td> <td>2</td> </tr> <tr> <td>HANDLER</td> <td>4</td> </tr> <tr> <td>Calibration Data</td> <td>8</td> </tr> </table>	No Error	0	CPLD	1	EEPROM	2	HANDLER	4	Calibration Data	8
No Error	0										
CPLD	1										
EEPROM	2										
HANDLER	4										
Calibration Data	8										
*OPC	It informs the 16502 to set the event register to OPC bit (bit 0) when the operation command is done.										
*OPC?	It returns 1 when all operations and queries are done.										
*CLS	It clears status data and the execution as described below. It clears error queue. It clears standard event status register. It clears status byte register. It clears operation event register.										
*ESE<numeric_value>	It sets the standard event status started register.										
*ESE?	It queries the bit in the standard event status started register.										
*ESR?	It queries the text of standard event status register. By using this command to read out the standard event status register for clearing the text. The query returns a numeric value in the format <NR1>.										
*SRE <numeric_value>	It sets the bit in the status byte started register.										
*SRE?	It queries the decimal representation in the text of status byte started register.										
*STB?	It queries the text of status byte register. The query returns a numeric value in the format <NR1>.										
*RCL	It recalls the below number of meter status that saved in EEPROM. MEAS DISPLAY Parameter										

	<p>SYSTEM CONFIG Parameter          COMPARE Function Parameter          BIN SORT Function Parameter          TEMPERATURE CONVERSION Parameter          RSCAN Parameter</p>
*SAV	<p>It saves the below status to EEPROM.          MEAS DISPLAY Parameter          SYSTEM CONFIG Parameter          COMPARE Function Parameter, the saved position is defined by numeric_value.          BIN SORT Function Parameter, the saved position is defined by numeric_value.          TEMPERATURE CONVERSION Parameter          RSCAN Parameter</p>
*TRG	<p>It triggers the 16502 in bus trigger mode as well as returns the measurement value after measured.</p>

## 5.4 Status Reporting Structure

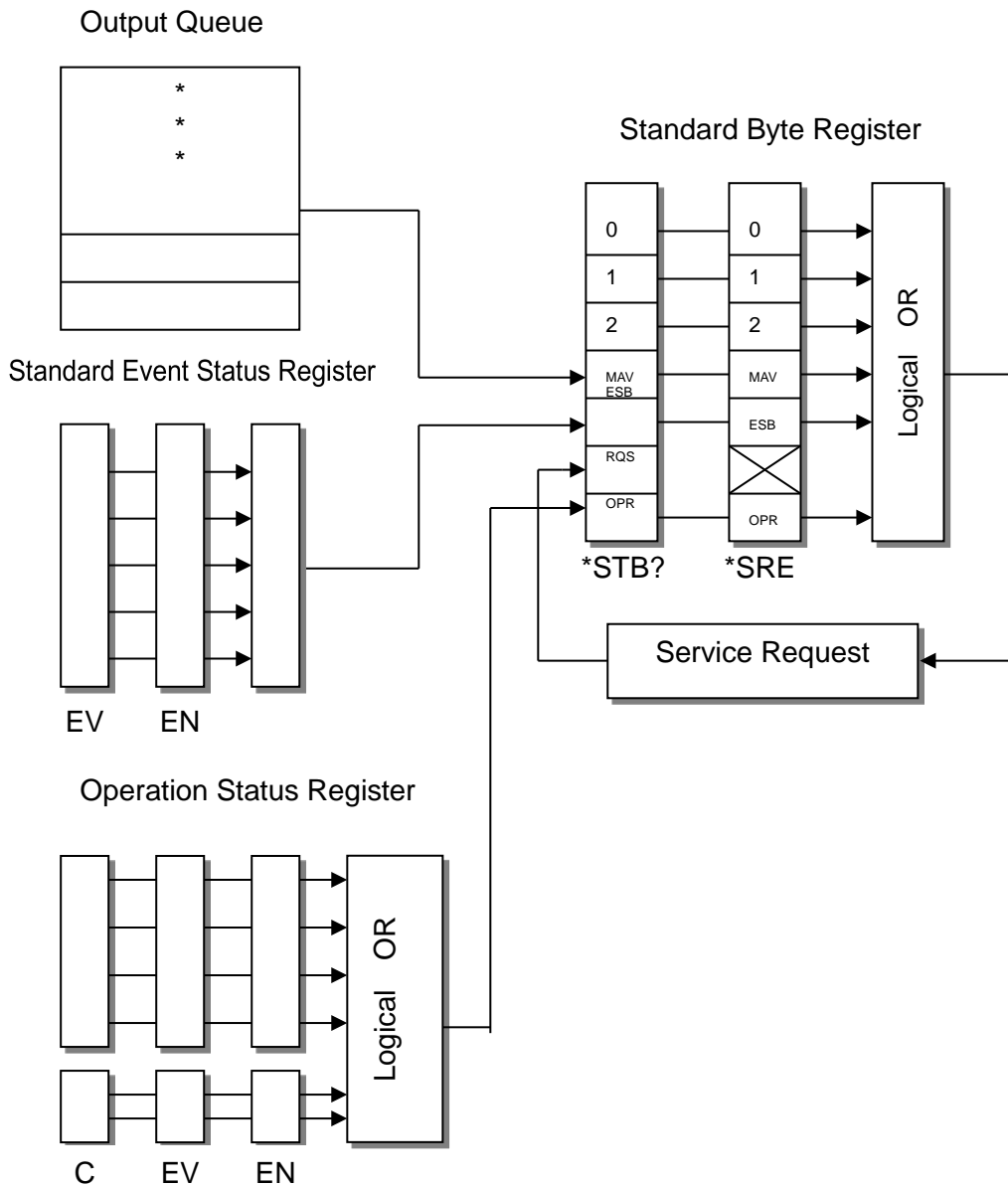

**Status Reporting Structure**

SRQ:

The 16502 Milliohm Meter can send an SRQ (Service Request) control signal when it requires the controller to perform a task. When the 16502 generates an SRQ, it also sets Bit 6 of the Status Byte Register, SRQ (Service Request) bit. Service Request Enable Register allows an operation programmer to select which summary messages in the Status Byte Register may cause service requests.

## 5.5 Status Byte Register

The Status Byte Register is composed of eight bits that summarize an overlaying status data structure. The Status Byte Register can be read using \*STB? to return a decimal expression of the register contents (which means the total byte weight of all the byte set to "1".)

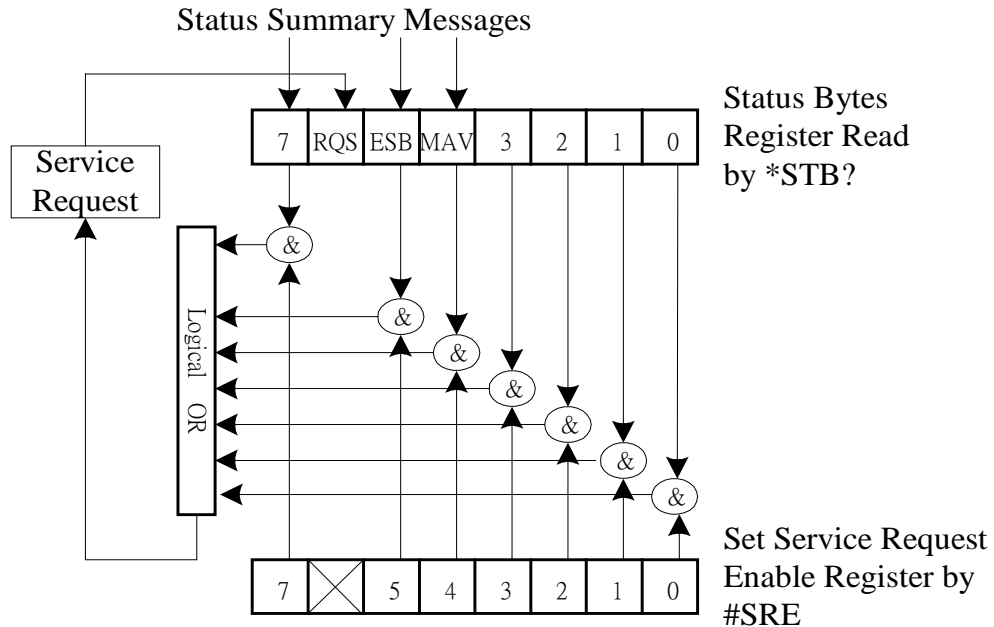

Bit No.	Bit Weight	Description
7	128	Operation Status Register Summary Bit
6	64	Request Service Bit. This bit is set when any enabled bit of the Status Byte Register has been set, which indicates 16502 has at least one reason for requesting service.
5	32	Standard Event Status Register Summary Bit.
4	16	Message Available Bit. This bit is set whenever the 16502 has data available in the output queue, and is reset when the available data is read.
3-0		Always 0.



## 5.6 Standard Event Status Register

The Standard Event Status Register is frequently used and is one of the simplest. The common use commands \*ESE and \*ESR? can be utilized to program it.

Summary  
 Message Event  
 Bit (ESB)  
 (Bit 5 of Status  
 Byte Register)

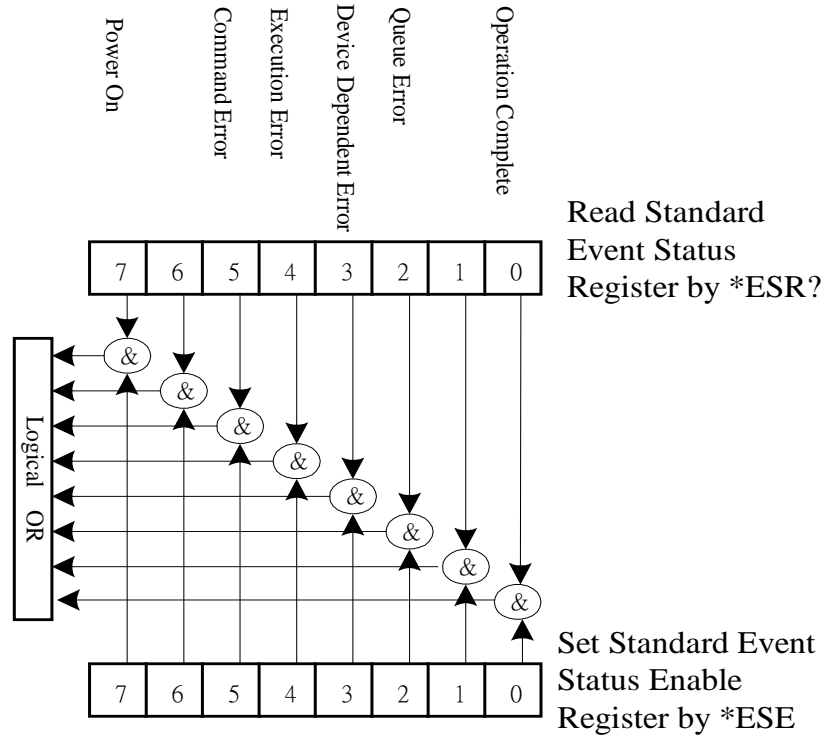

Bit No	Bit Weight	Description
7	128	Power on Bit. Power off the 16502 and turn on again, this bit is set to 1.
6		Always 0.
5	32	Command Error Bit. This bit is set to 1 if there is any IEEE 488.2 syntax error.
4	16	Execution Error Bit. This bit is set to 1 when the command parameter is out of valid range or inconsistent.
3	8	Device Dependent Error Bit. This bit is set to 1 when too many errors have occurred that the error queue is full.
2	4	Queue Error Bit. This bit is set to 1 when reading data from the output buffer and no data is present, or when the data is lost.
1		Always 0.
0	1	

## 5.7 Operating Status Group

The 16502 Milliohm Meter provides STATus subsystem commands to access operation status register (please refer STATus subsystem in the command structure). It includes an event register and an enable register. Enable register enables corresponding bit in event register.

The enable register enables the corresponding bit in the event register to set the status summary bit and bit 7 of the Status Byte Register.

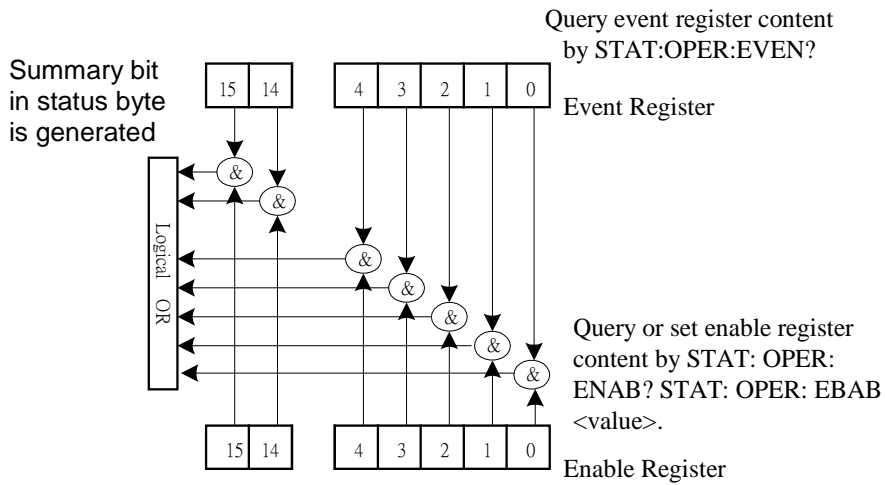

Bit No	Bit Weight	Description
6-15		Always 0.
5	32	This bit is set to 1 when the 16502 can accept a trigger.
4	16	This bit is set to 1 when the 16502 is actively measuring.
3		Always 0.
2		Always 0.
1		Always 0.
0		Always 0.

## 5.8 RS-232C Interface Connector

The RS232 of instrument is a connector with 9 pins.

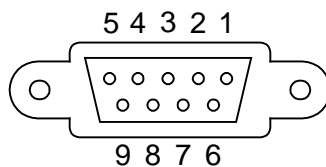

## 5.9 RS-232C Signal Line and Pin Assignment

	Pin	Name	Description
Ground	5	GND	Ground wire
Data	3	/TxD	Transmitting data
	2	/RxD	Receiving data



## 6. Description of ZERO Correction

1. Power on the instrument after all are normal, enter main index as the below screen shown.

< MEAS. DISPLAY >		
*	$R_x : 190.01\text{m}\Omega$	DRIVE : PULSE+/- F1 ← Select test mode
		DRY : OFF F2 ← Select DRY CIRCUIT OFF or ON
		TRIG. : INT F3 ← Select trigger mode
		NEXT PAGE 1/4 F4 ← Switch to next page (Now is page 1)

2. Press [F4] to enter the screen as below shown.

< MEAS. DISPLAY >		
*	$R_x : 190.01\text{m}\Omega$	RANGE : A 200mΩ F1 ← Select range
		SPEED : FAST F2 ← Select test speed
		ZERO : OFF F3 ← Select zero function OFF or ON
		NEXT PAGE 2/4 F4 ← Switch to next page (Now is page 2)

3. Deduct the residual impedance from test fixture or test cable.

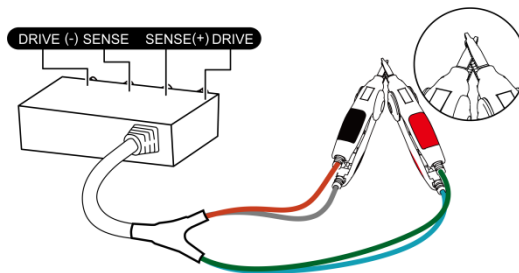

The figure shown above is for telling users to do test cable zero at present. Be aware that connection is for connecting  $H_{CUR}$  and  $L_{CUR}$  after the test cable is connected as above figure. Next, the connection of  $POT$  and  $CUR$ , please prepare the test cable and press [F3] for the screen turning into ON that test cable zero action is already processed.

For example:

< MEAS. DISPLAY >		
*	$R_x : 0.037\text{m}\Omega$	RANGE : A 20 mΩ F1
		SPEED : SLOW F2
		ZERO : OFF F3 ← Select zero function OFF
		NEXT PAGE 2/4 F4

The screen is shown as below after [F3] is pressed.

< MEAS. DISPLAY >		
*	$R_x : 0.000\text{m}\Omega$	RANGE : A 20 mΩ F1
		SPEED : SLOW F2
		ZERO : ON F3 ← Select zero function ON
		NEXT PAGE 2/4 F4



## 7. Description of Handler Interface

BINNING and COMPARE in 16502 are all connected to external unit by Handler interface. The connectors are 24 Pin, pin descriptions are as following.

### 7.1 Description of Handler Interface Pins for BINNING

Pin	Name	Description
1	/EXT	Triggered externally
2	X	N.C
3, 20	BIN 7	BIN 7, primary parameter test value of Rx is within BIN 7 setting range
4, 24	BIN 8	BIN 8, primary parameter test value of Rx is within BIN 8 setting range
5,6,7	GND	Ground the external
8	COMMON	Ground the internal power source
9,13,15	BIN OUT	BIN OUT, primary parameter test value of Rx is not in all setting specifications
10	VEXT	External DC voltage, acceptable range is +5V~24V
11	VINT	Internal DC voltage +5V
12	X	N.C
14	BIN 5	BIN 5, primary parameter test value of Rx is within BIN 5 setting range
16	BIN 6	BIN 6, primary parameter test value of Rx is within BIN 6 setting range
17	BIN 1	BIN 1, primary parameter test value of Rx is within BIN 1 setting range
18	/EOT	End of test.
19	BIN 2	BIN 2, primary parameter test value of Rx is within BIN 2 setting range
21	BIN 3	BIN 3, primary parameter test value of Rx is within BIN 3 setting range
22	/ACQ	End of the analog sampling. It is able to shift the next DUT to the 16502 test terminal.
23	BIN 4	BIN 4, primary parameter test value of Rx is within BIN 4 setting range

## 7.2 Description of Handler Interface Pins for COMPARE

Pin	Name	Description
1	/EXT	Triggered externally
2	X	N.C
3,20	/FAIL LO	Primary parameter test value of Rx too low
4,24	/FAIL HI	Primary parameter test value of Rx too high
5-7	GND	Ground
8	COMMON	Ground the internal power source
9,13	X	N.C
10	VEXT	External DC voltage, acceptable range is +5V~24V
11	VINT	Internal DC voltage +5V
12	X	N.C
14	X	N.C
15	/FAIL	Test value of Rx is not in specification
16	X	N.C
17	X	N.C
18	/EOT	End of Test
19	X	N.C
21	/PASS	Primary parameter test value of Rx is in specification
22	/ACQ	End of the analog sampling. It is able to shift the next DUT to the 16502 test terminal.
23	X	N.C



## 8. Descriptions of Temperature Measurement and Correction Function

Temperature measurement function calculates the value of unknown temperature by the condition of known temperature and resistance values. It is often used to calculate the change of transformer or motor coil.

However, temperature correction function calculates the value of unknown resistance by the condition of known temperature and resistance values. It is often used on the conversion of lead resistance value.

### 8.1 Description for Temperature Measurement Function

This function should be used with optional interface and probe coordinately.

#### 8.1.1 Optional Interface for Measuring Temperature

The interfaces for measuring temperature are installed into the rear panel of 16502 as below shown. Using the port of TC SENSOR on the panel mainly inputs the temperature measurement as the following figure.

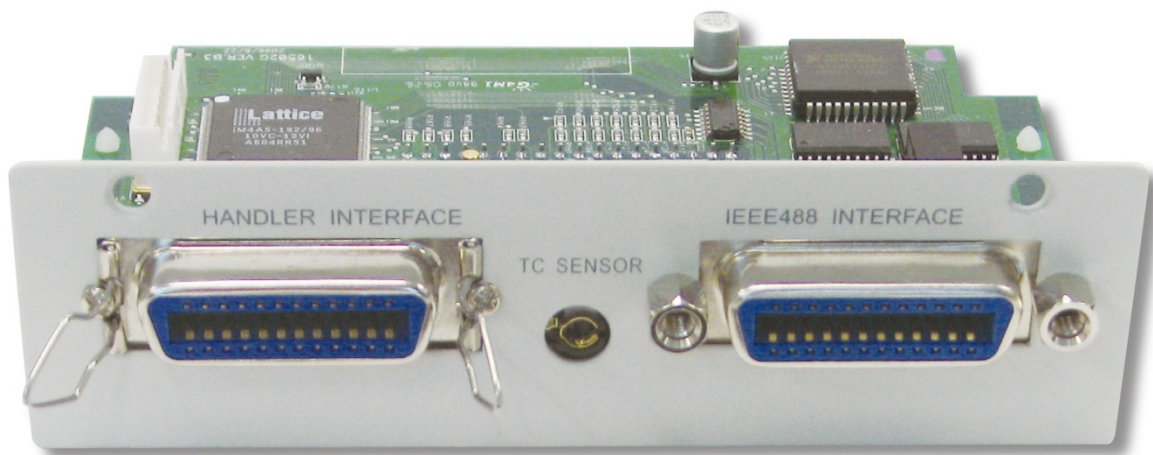

#### 8.1.2 Probe

The standard measurement probe is PT100 type of platinum temperature sensor and it is 1.5m in length. The probe head is capable of measuring  $-50^{\circ}\text{C} \sim 300^{\circ}\text{C}$ . Plug the connector of end into the port of TC SENSOR on the rear panel of 16502. The temperature measurement probe is as below shown.



(rt): Measured resistance value

(t): Ambient temperature as measuring

(T): Resistance value is temperature constant of zero (copper: 235; aluminum: 230)

Ex.:

The initial temperature(t0) of a copper wire is 20°C as well as initial resistance value(r0) of that is 200mΩ. We assumed that ambient temperature (t) is 25°C and then the measured resistance is 210mΩ. At this time, the copper wire temperature variation (Δtn) can be obtained as following formula.

$$\Delta t_n = r_t / r_0 * (T + t_0) - (T + t)$$

\*T is temperature constant. (Copper: 235;  
Aluminum: 230)

$$= (210 \text{ e-}3) / (200 \text{ e-}3) * (235 + 20) - (235 + 25) = 7.75 \text{ } ^\circ\text{C}$$

That is to say, the temperature variation of copper wire is increment of 7.75°C. The temperature is ambient plus varied temperature *i.e.* 25°C + 7.75°C= 32.75°C.

## 8.2.2 Description for Setting Menu

Temperature measurement function needs to set the following three conditions.

1. INIT RESISTANCE: Initial resistance value (r0) setting.
2. INIT TEMP : Initial temperature (t0) setting.
3. CONSTANT : Resistance value is temperature constant of zero. (Copper: 235; Aluminum: 230)

Setting procedure:

- (1) Press [MAIN INDEX] after 16502 powered-on, thus the following screen will be shown.

< MAIN INDEX >	
C O M P A R E	F1
B I N N I N G	F2
T E M P . C O N V .	F3 ← Temp. conversion setting
R S C A N	F4

- (2) Next, press TEMP.CONV. [F3] in Main Index, the screen is shown as below.

< MAIN INDEX : TEMP . CONV . >	
S E T T I N G	F1 ← The various conditions setting of temp. conversion.
_____	F2
_____	F3
M E A S U R E	F4 ← The measurement for temp. conversion.

- (3) Press Setting [F1] to enter to condition setting screen as below.

Setting screen:

< TEMP. CONV. SET >		
INIT RESISTANCE: 001.000mΩ	DIGIT UP	F1 ← The cursor positioned number digit up.
INIT TEMP : +020.0 °C	DIGIT DOWN	F2 ← The cursor positioned number digit down.
CONSTANT : 235.0	DIGIT	F3 ← The cursor move right.
Press MAIN INDEX to exit		F4

The various functions of Setting Screen

INIT RESISTANCE: Initial resistance value (r0) setting.

INIT TEMP : +020.0°C initial temperature(t0) setting.

CONSTANT : 235.0 resistance value is temperature constant of zero. (Copper: 235; Aluminum: 230)

The adjustment of various conditions is selected by [ $\Delta$ ], [ $\nabla$ ]. By use of DIGIT [F3] to select the digit you want to adjust, DIGIT UP [F1] to increase the digit along with DIGIT DOWN [F2] to decrease the digit.

### 8.2.3 Description for Operating Menu

1. Press [MAIN INDEX] after 16502 powered-on then press TEMP.CONV. [F3], thus the following screen will be shown.

< MAIN INDEX: TEMP. CONV. >		
	SETTING	F1 ← The various conditions setting of temp. conversion.
		F2
		F3
	MEASURE	F4 ← The measurement for temp. conversion.

2. Press Measure [F4] to enter to Temp. Meas. as below figure.

< TEMP. CONV. MEAS. >		
* R <sub>x</sub> : 190.01mΩ	RANGE: A 200mΩ	F1 ← Test range setting
T : 45.4 °C	DISP : T	F2 ← Temp. display setting
AMBIENT TEMP: +025.5 °C	TEMP.: AUTO	F3 ← Temp. measurement setting
	NEXT PAGE: 1/1	F4 ← Change to the first page

There are two types of temp. measurement display: T and  $\Delta$ T. It is mainly by [F2] key to change the display. T mode shows converted component temperature.  $\Delta$ T mode shows temp. variable of converted component.

ΔT mode display screen:

< TEMP. CONV. MEAS. >		RANGE : A 200 mΩ	F1
*		DISP : ΔT	F2 ← Temp. display setting
R <sub>x</sub> :	190.01 mΩ	TEMP. : AUTO	F3 ← Temp. measurement setting
ΔT :	25.4 °C	NEXT PAGE : 1/1	F4
AMBIENT TEMP : +025.5 °C			

3. There are three kinds for measuring temp., by use of [F3] to change the selection. Their explanations are described as follows.

(1) TEMP.: OFF

< TEMP. CONV. MEAS. >		RANGE : A 200 mΩ	F1
*		DISP : T	F2
R <sub>x</sub> :	190.01 mΩ	TEMP. : OFF	F3 ← Temp. measurement setting is TEMP. : OFF
T :	45.4 °C	NEXT PAGE : 1/1	F4

TEMP.: OFF. This selection indicates temp. measurement function is disabled, thus the screen won't show temp. measurement value. The panel shows temp. (T) under this selection is converting directly by resistance value of DUT.

Calculation formula:

$$\frac{r_0}{R_2} = \frac{235+t_0}{35+T_2}$$

← r<sub>0</sub> is a resistance value as temperature equals to T<sub>1</sub>.  
← R<sub>2</sub> is a resistance value as temperature equals to T<sub>2</sub>.

r<sub>0</sub> represents Init Resistance: Initial resistance value.

t<sub>0</sub> represents Init Temp : Initial temp.

235 represents Constant : Resistance value is temperature constant of zero.  
(Copper: 235; Aluminum: 230)

R<sub>2</sub> represents the resistance value of DUT.

(2) TEMP.: AUTO

< TEMP. CONV. MEAS. >		RANGE : A 200 mΩ	F1
*		DISP : T	F2
R <sub>x</sub> :	190.01 mΩ	TEMP. : AUTO	F3 ← Temp. measurement setting is TEMP. : AUTO
T :	45.4 °C	NEXT PAGE : 1/1	F4
AMBIENT TEMP : +025.5 °C			

TEMP.: AUTO. This selection indicates temp. auto measurement as well as the measurement value of current ambient temp. will be displayed. The panel shows T under this selection is the converted temp. value (temp. variable) plus the value of ambient temperature.

(3) TEMP.: +020.0°C

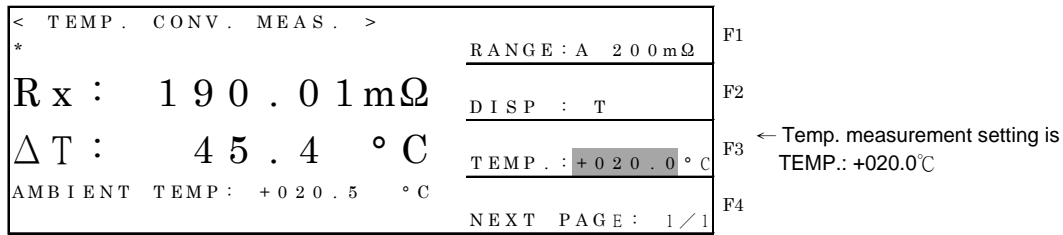

TEMP.: +020.0°C. This selection is for user to input temp. value t(°C). When the user is without temp. probe thus other thermometers can be referred and input the current temp. value (ambient temp.) by user. The panel shows T under this selection is the converted temp. value (temp. variable) plus the value by user inputted. The adjustment of value is by pressing [Δ], [▽], [◀] and [▶]. [◀] and [▶] are for adjusting large scale, however [Δ] and [▽] are for fine adjustment.

## 8.2.4 Operation Example

About more detailed measurement operation example please refer 8.2.1 “Conversion Function”.

(1) Parameter setting:

INIT RESISTANCE → (r0): Initial resistance value → 200 mΩ

INIT TEMP → (t0): Initial temperature → 20°C

CONST CONSTANT → (T): Resistance value is temperature constant of zero → 235

Press [MAIN INDEX] on panel then press TEMP.CONV. [F3] key as well as SETTING [F1] key, meanwhile you can enter the condition screen for setting parameter.

Condition setting screen:

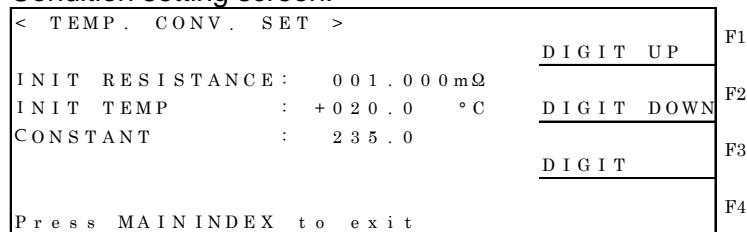

(2) Press [MAIN INDEX] on panel then press TEMP.CONV. [F3] key as well as MEASURE [F4] key, meanwhile you can enter temp. measurement screen.

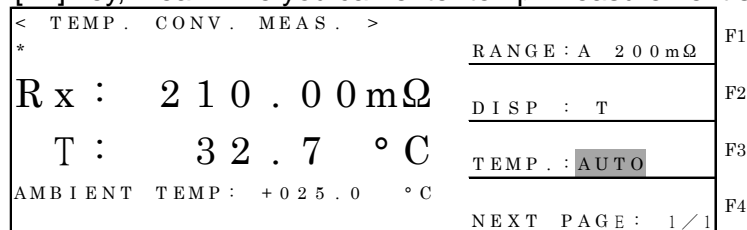

T: 32.7°C represents temp. value that component after calculated.

## 8.3 Description for Temp. Correction Function

Temp. correction function is mainly by using the resistance value of known specific temperature (for instance, 30°C is 100Ω) of lead (ex. copper, aluminum wire) as well as known temp. coefficient (ex. 3930PPM) to infer the other resistance value when temp. is 20°C.

### 1. Temp. correction formula

$$R_{t0} = R_t / \{ 1 + \alpha_{t0} * (t - t_0) \}$$

Within:

$R_{t0}$ : Specified temp. resistance value that you want to convert

$R_t$ : The measured resistance value under ambient temp.

$\alpha_{t0}$ : Coefficient of specified temp.

$t$ (°C): Ambient temp.

$t_0$  (°C): Specified temp. that you want to convert

### 2. Example:

In this example, the ambient temp. is 30°C, meanwhile the resistance value of measured copper wire is 100Ω. How many the resistance value is when you want to convert 20°C? The user needs to input the value (20°C) which want to convert and temp. coefficient. When the conduction coefficient closes to 1, thus temp. coefficient of copper is 3930 ppm.

The condition of calculation is 100Ω copper wire under 30°C ambient temp.. The conversion step of resistance value under 20°C ambient temp., please follows 3930 ppm temp. coefficient.

$R_{t0}$ : Unknown resistance value

$R_t$ : 100Ω

$\alpha_{t0}$ : 3930 ppm

$t$ (°C): 30 °C

$t_0$  (°C): 20°C

$$R_{t0} = R_t / \{ 1 + \alpha_{t0} * (t - t_0) \} = 100 / \{ 1 + (3930 \text{ e-6}) * (30 - 20) \} = 96.21 \Omega$$

### 8.3.1 Setting Description

The setting of temp. correction is mainly converting two conditions of specified temp.  $t_0$  (°C) of resistance along with lead temp. coefficient  $\alpha_{t0}$  for accomplishment of resistance value under specified temperature.

#### Setting steps:

1. After powered-on, press [System Setup] to enter the screen as follows.

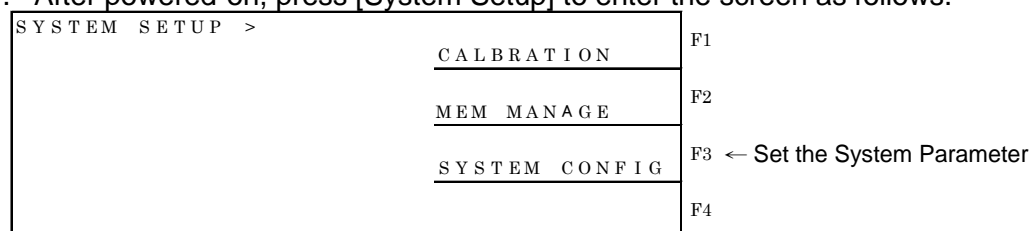

2. Press [F3] (i.e. SYSTEM CONFIG) key to enter System Config Screen as below figure.

< SYSTEM CONFIG >		DIGIT UP	F1
AVERAGE NO. :	01		
BEEPER :	HIGH	DIGIT DOWN	F2
KEY LOCK :	OFF		F3
CONTRAST :	07		
SOUND MODE :	FAIL		F4

3. System Config Screen consists of three pages, you can press [△], [▽] to move the System Config Screen consists of three pages, you can press [△], [▽] to move the cursor to another page. Please choose it by pressing [▽] until the third page.

The third page is as below figure:

< SYSTEM CONFIG >		50 Hz	F1
LINE FRE. :	60 Hz		
GPIB ADDRESS :	17	60 Hz	F2
BAUDRATE :	19200		F3
CORREC. TEMP :	+20.0 °C		
THERM. COEFF. :	3930 ppm		F4

In this screen, CORREC.TEMP means to set the specified temp. value  $t_0$  (°C) that you want to convert resistance. However, THERM. COEFF means to set temp. coefficient  $\alpha_{t_0}$ .

The adjustment of value is by [◀] and [▶] for large scale as well as DIGIT UP[F1] and DIGIT DOWN[F2] for fine adjustment.

### 8.3.2 Operating Description

1. After powered-on, if you want to show the following screen at any time, just press [Meas Display] key to enter Meas. Display Screen.

Temp. Correction Meas. is the third page in MEAS. Display Screen. Please use [F4] key to change the page.

Meas. display of temperature correction:

< MEAS. DISPLAY >		COMPARE : OFF	F1
* $R_{TC}$ :	190.01 mΩ	BINNING : OFF	F2
		TEMP. : AUTO	F3
	TEMP. : +25.5 °C	NEXT PAGE 3/4	F4 ← Switch to next page (Now is page 3)

2. After entering Meas. Display and then press [F3] key to select three function modes of TEMP.: AUTO , TEMP.: +20.0 and TEMP.: OFF.



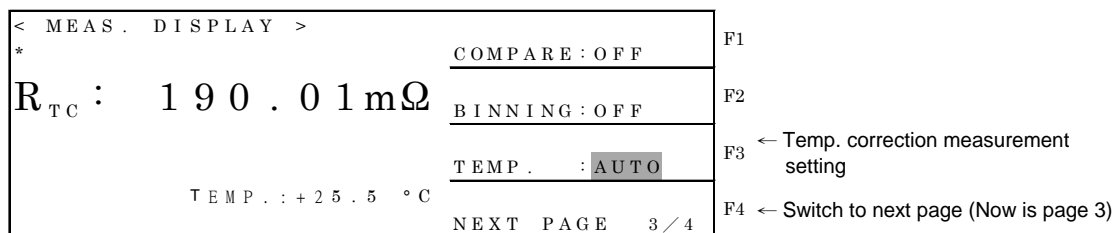

Three functions descriptions of temp. correction measurement are described separately as follows.

(1) TEMP.: OFF

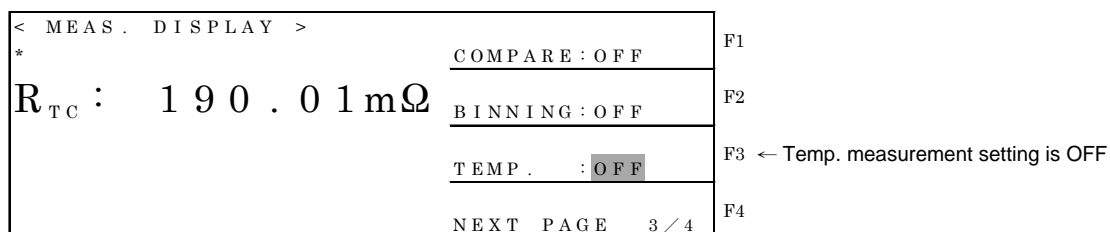

TEMP.: OFF. This selection indicates temp. measurement function is disabled, thus the screen won't show temp. measurement value. The panel shows resistance ( $R_x$ ) under this selection that is the resistance value of DUT.

(2) TEMP.: AUTO

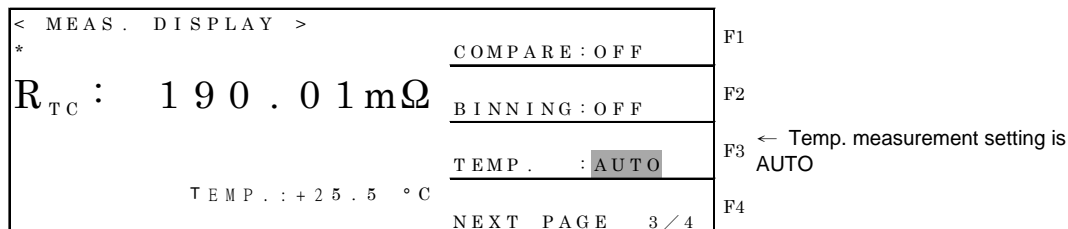

TEMP.: AUTO. This selection indicates temp. auto measurement as well as the measurement value of current ambient temp. will be displayed. The panel shows  $R_{TC}$  is a resistance value after specified temp. converted (CORREC.TEMP setting in SYSTEM CONFIG) under this selection.

(3) TEMP.: +20.0

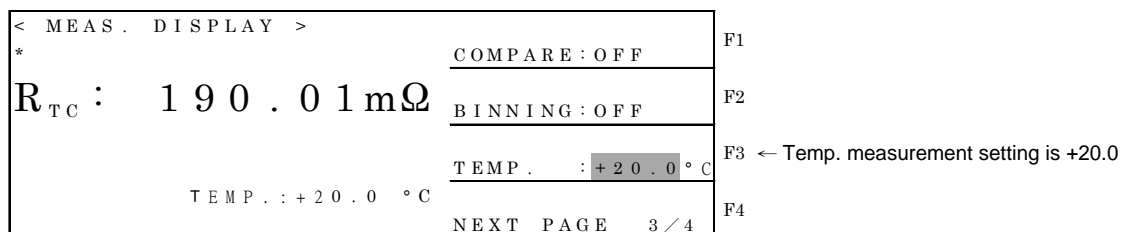

TEMP.: +20.0. This selection is for user to input temp. value  $t(^{\circ}\text{C})$ . When the user is without temp. probe thus other thermometers can be referred and input the current temp. value (ambient temp.) by user. The adjustment of value is by pressing [ $\Delta$ ], [ $\nabla$ ], [ $\leftarrow$ ] and [ $\rightarrow$ ]. [ $\leftarrow$ ] and [ $\rightarrow$ ] are for adjusting large scale,

however [ $\Delta$ ] and [ $\nabla$ ] are for fine adjustment. The panel of 16502 shows  $R_{TC}$  is a resistance value after converted under this selection.

### 8.3.3 Operation Example

In the above section example, the ambient temp. is 30°C, meanwhile the resistance value of measured copper wire is 100Ω. How many the resistance value is when you want to convert 20°C? The user needs to input the value (20°C) which want to convert and temp. coefficient. When the conduction coefficient closes to 1, thus temp. coefficient of copper is 3930 ppm.

The condition of calculation is 100Ω copper wire under 30°C ambient temp.. The conversion step of resistance value under 20°C ambient temp., please follows 3930 ppm temp. coefficient.

$R_{t0}$ : Unknown resistance value  
 $R_t$ : 100Ω  
 $\alpha t_0$ : 3930 ppm  
 $t(^{\circ}\text{C})$ : 30°C  
 $t_0(^{\circ}\text{C})$ : 20°C

$$R_{t0} = R_t / \{1 + \alpha t_0 \cdot (t - t_0)\} = 100 / \{1 + (3930 \text{ e-6}) \cdot (30 - 20)\} = 96.21\Omega$$

Its operation steps as follows.

- (1) Parameter setting  $t_0(^{\circ}\text{C})$ : 20°C  
 $\alpha t_0$ : 3930 ppm

Press [System Setup] on panel then [F3] key (*i.e.* SYSTEM CONFIG) as well as press [ $\Delta$ ] and [ $\nabla$ ] to move the cursor to the next selection. Set CORREC. TEMP to +20.0°C and THERM. COEFF to 3930 PPM.

< SYSTEM CONFIG >		F1
LINE FRE. :	60 Hz	50 Hz
GPIB ADDRESS :	17	60 Hz
BAUDRATE :	19200	F3
CORREC. TEMP :	+20.0 °C	F4
THERM. COEFF. :	3930 ppm	

- (2) Press [Meas Display] on panel then [F4] key to change to the third page as well as press [F3] to select TEMP.: AUTO, thus the screen will show the converted resistance value. (In the above example, ambient temperature is 30.0°C and the resistance value which measured by 16502 output terminal is 100Ω. Therefore, the converted result  $R_{TC}$ : 96.21Ω.)

< MEAS. DISPLAY >		F1
* $R_{TC}$ :	96.21 Ω	COMPARE : OFF
		BINNING : OFF
		TEMP. : AUTO
TEMP. :	+30.0 °C	F4
NEXT PAGE 3/4		

## 9. R SCAN Function

Fan and Motor are combined by multiple groups of coils and should be inter-balanced between coils or it may cause abnormal sound. Thus, test if the coils balance is needed. The 16502 provides R Scan Function plus R Scanner for customer test. For measurement more accuracy, the customer can use it with temperature compensation function. R SCAN function should be coordinated with purchased R SCANNER.

### 9.1 R Scan Interface

R SCAN interface is for an R SCANNER installed on output terminal of 16502 front panel. It is connected and controlled with the 16502 via D-SUB 9Pin changing to Handler control line.

The diagram of 16502 Milliohm Meter, R Scanner and User Controller is shown below.

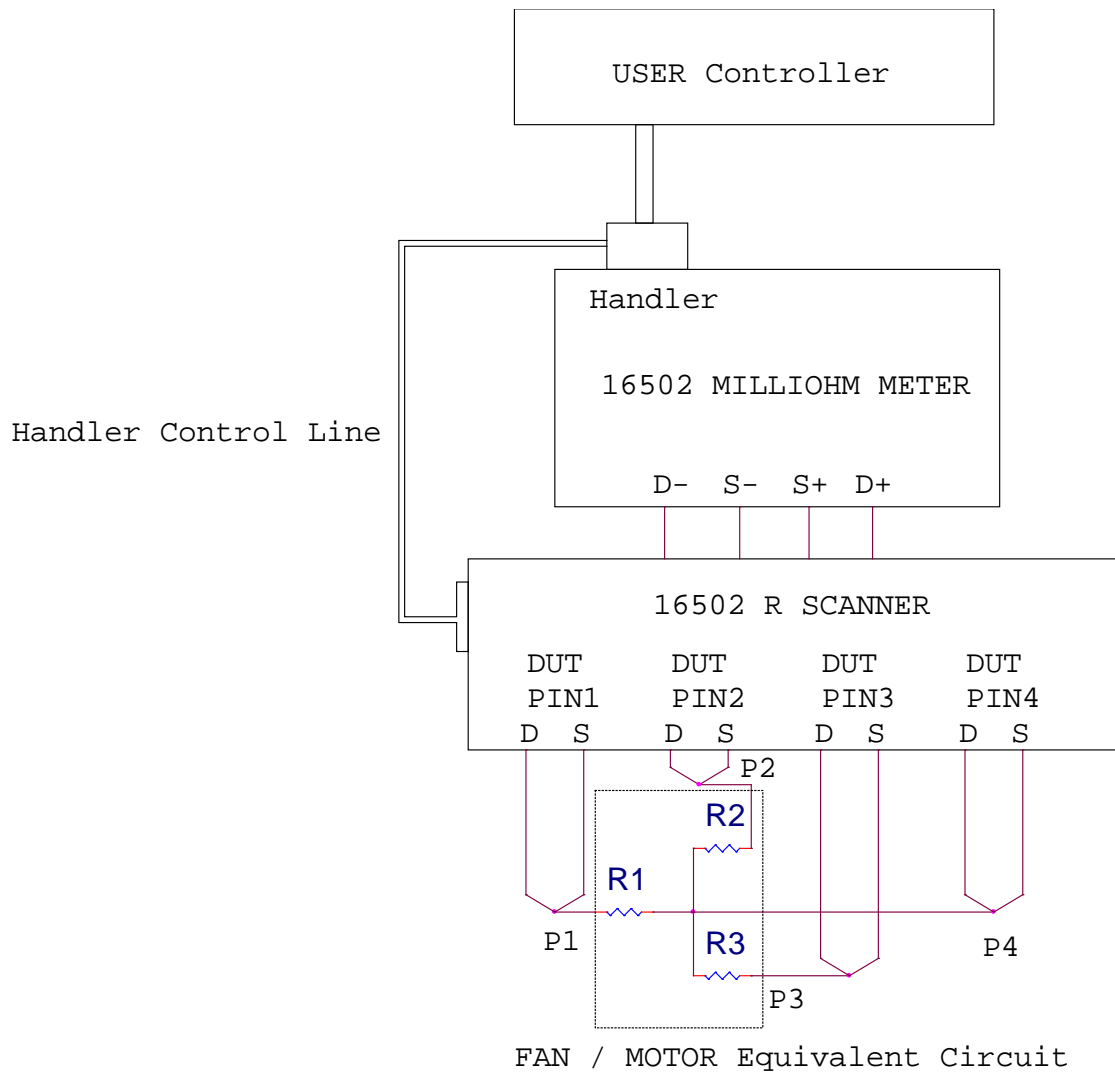

Fan/Motor **Equivalent** Circuit

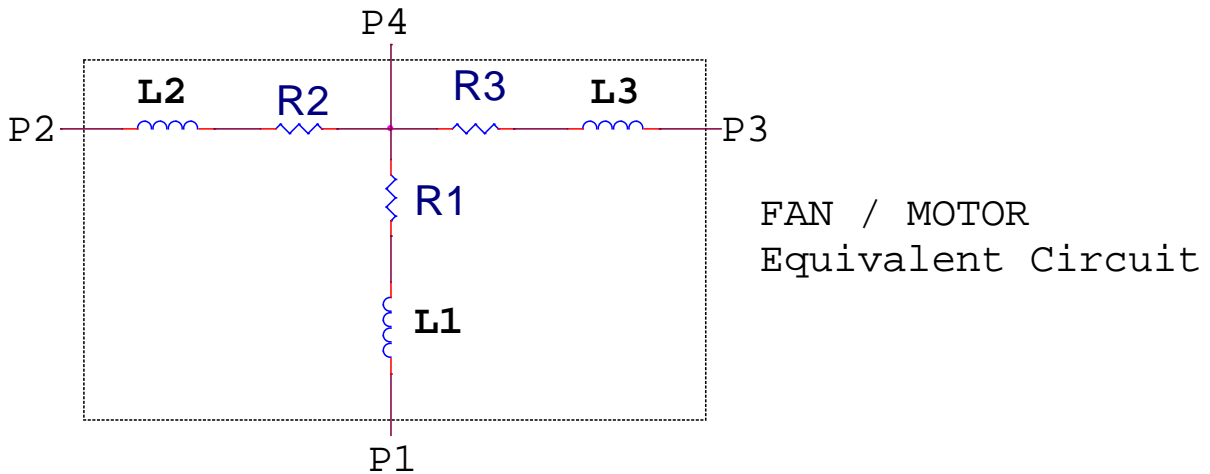

The 16502 Miliohm Meter provides control signal and power to R Scanner via Handler interface. To transmit /EXT, PASS and FAIL signals by using Handler interface to connect with User Automatic Machine.

The output signals of D-, S-, D+ and S+ in the 16502 Miliohm Meter can be connected to the pins set for measuring the setting equivalent resistance through R Scanner.

## 9.2 R Scanner Specification

Main Function		
16502 R Scanner Test Fixture		
Measurement Time (For three DCRs)		
Speed	Temp AUTO	Temp OFF
Fast	60ms	40ms
Medium	120ms	95ms
Slow	550ms	430ms
Electrical Specifications		
Measure Method	Four-terminals testing	
Scan Number	1~3	
Collocation Number	6(1-2,1-3,1-4,2-3,2-4,3-4)	
Fixture rated Watt	<1.1W(max)	
Fixture Rated Current	1A dc	
Test Terminal Connection Cable	24 pins Handler, 24 pins Handler—9 pins D-SUB x1	
Interface	Handler Bus	
Mechanical Specifications		
Screw size	M3x6x2	
Size (W x H x D)	117mm x 66mm x 37mm	

## 9.3 Operation for R SCAN

### 9.3.1 R SCAN Setting Step

1. Press **MAIN INDEX** after 16502 powered on, the screen is shown below.

< MAIN INDEX >		COMPARE	F1
		BINNING	F2
		TEMP. CONV.	F3
		R SCAN	F4 ← R SCAN setting

2. Next press “R SCAN [F4]” under MAIN INDEX, the screen is shown below.

< MAIN INDEX - RSCAN >		SETTING	F1 ← R SCAN test various conditions setting
			F2
			F3
		TEST	F4 ← R SCAN measurement

3. Press “SETTING [F1]” to enter condition setting menu is given below.

< R SCAN SET >			F1 ← The cursor positioned number digit up.
NOMINAL : 000.0000 Ω		DIGIT UP	
	HIGH	LOW	F2 ← The cursor positioned number digit down.
1 1 - 4	000.0000 Ω	000.0000 Ω	DIGIT DOWN
2 2 - 4	000.0000 Ω	000.0000 Ω	
3 3 - 4	000.0000 Ω	000.0000 Ω	DIGIT
ΔR	000.0000 Ω		F3 ← The cursor move right.
Press MAIN INDEX to exit			F4

Press [△], [▽], [◀] and [▶] to select the item to be set after entering R SCAN SET menu. Press F1 to increase digit, F2 to decrease digit, F3 to select adjusted digit and F4 to select high/low limit mode.

There are three groups of DCR in 16502 R SCAN function for test and pin variation. The setting method is as the table below. The Default is for setting three groups of DCRs. The extra DCR set to 0-0 via F1, F2 and F3 when these three groups of setting not to be used.

DUT Pin	Setting	R SCAN Measurement Equivalent Resistance
Pin 1 to Pin 2	1-2	R1+R2
Pin 1 to Pin 3	1-3	R1+R3
Pin 1 to Pin 4	1-4	R4
Pin 2 to Pin 3	2-3	R2+R3
Pin 2 to Pin 4	2-4	R2
Pin 3 to Pin 4	3-4	R3
Pin 0 to Pin 0	0-0	Not tested

Input the DUT nominal value to NOMINAL column and set the high limit of judgment test value in HIGH numeric column as well as the low limit of that in LOW numeric column aside the pin. PASS will be shown on if the test result meets high/low limit of the setting and FAIL will be shown conversely. Press F4 for the high/low limit to select ABS MODE or % MODE.

$\Delta R$  indicates the differences between max. and min. test values of three DUTs as well as the high limit can be set. The monitor will show FAIL when  $\Delta R$  is over the high limit.

### 9.3.2 Test Description for R SCAN

1. Press **MAIN INDEX** to return to < MAIN INDEX-R SCAN> menu after R SCAN setting completed. Moreover, press F4 to enter TEST menu.

< MAIN INDEX - R SCAN >		
	SETTING	F1 ← R SCAN test various conditions setting
	_____	F2
	_____	F3
	TEST	F4 ← R SCAN measurement

2. R1, R2, R3 and  $\Delta R$  show measurement result as well as judgment result included under < R SCAN TEST> menu.

< R SCAN TEST >		
*	SPEED : FAST	F1
R 1 : ----- MΩ HI	TRIG : MAN .	F2
R 2 : ----- MΩ HI	ZERO . : OFF	F3
R 3 : ----- MΩ HI	TEMP . : OFF	F4
$\Delta R$ : ----- MΩ HI		

#### **SPEED: [F1]**

It sets measurement speed. FAST means in fast speed, MEDIUM indicates in medium speed as well as SLOW stands slow speed. The lower speed is, the more stability is. Change the measurement speed directly by pressing [F1]. The factory default value is FAST.

#### **TRIG.: [F2]**

It sets trigger mode. There are three modes include **INT**ernal, **EXT**ernal and **MAN**ual. Press [F2] to change the setting directly. The factory default value is INT.

#### **ZERO: [F3]**

It sets zero action. Be able to deduct residual resistance from test fixture or test cable. Press [F3] to select OFF or ON directly under this screen. The factory default value is OFF.

#### **TEMP.: [F4]**

It sets temp. compensation function. Three selections consist of OFF, AUTO and +20°C. Press [F4] to change the setting under this screen. AUTO function is for temperature auto measuring which shows the measurement in currently temperature. AUTO function won't be showed when 16502 temperature card doesn't be inserted. Furthermore +20°C temperature value inputted by manual, the numeric isn't 20 definitely but just an example. The detailed operations please see 8.3.2 *Operating Description*.

**R SCAN Connection Diagram**

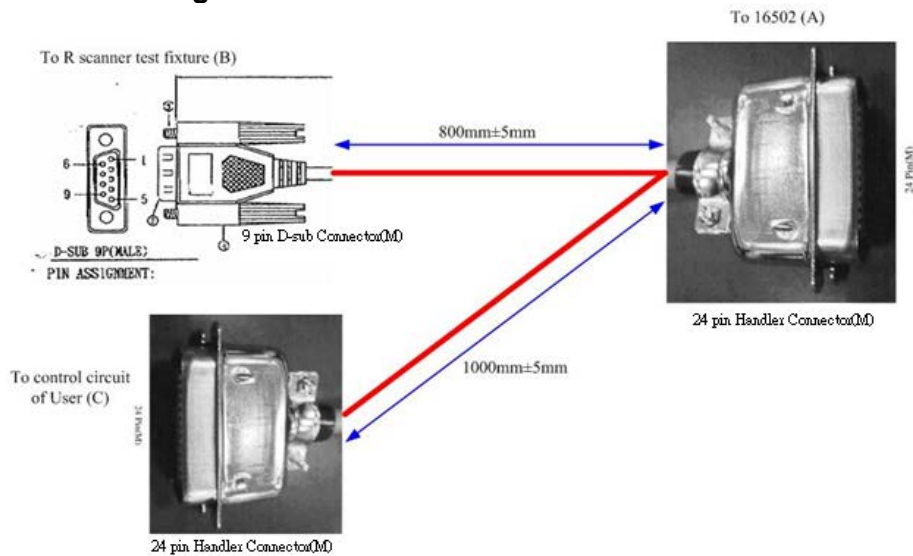

Pin list:

Handler interface of 16502 (Connector A)		D-sub 9 pin of R scanner test fixture (Connector B)		Handler 24 pin of ATS (Connector C)	
P01	/EXT	-	-	P01	/EXT
P04,P24	RESERVE	-	-	P24	RESERVE
P05	GND	P08	GND	P05	GND
P06	GND	-	-	P06	GND
P07	GND	-	-	P07	GND
P08	COMMON	P01	COMMON	P08	COMMON
P09,P13	RESERVE	-	-	P13	RESERVE
P10	VEXT	-	-	P10	VEXT
P11	VINT	P02	VINT	P11	VINT
P15	Total Fail	-	-	P15	Total Fail
P18	/EOT	-	-	P18	/EOT
P21	PASS,BIN3,Total PASS	-	-	P21	Total PASS
P22	/ACQ	-	-	P22	/ACQ
P14	BIN5,H2	P03	N1	-	-
P16	BIN6,H3	P04	N2	-	-
P17	BIN1,L3	P05	P1	-	-
P19	BIN2,L4	P06	P2	-	-
P23	BIN2,L4	P07	ENABLE	-	-





## **Chroma's Continuous Quality Process User Manual Customer Feedback**

Chroma welcomes all comments and recommendations to improve this publication in the future editions. Please scan the QR code below or click the URL <http://www.chromaate.com/survey?n=793ce6db-17ef-4cd3-b0de-8bbd09aa38e0> to fill in the customer feedback form. Thank you!





CHROMA ATE INC.

致茂電子股份有限公司

66 Huaya 1st Road, Guishan,

Taoyuan 33383, Taiwan

台灣桃園市 33383 龜山區

華亞一路 66 號

T +886-3-327-9999

F +886-3-327-8898

Mail: [info@chromaate.com](mailto:info@chromaate.com)

<http://www.chromaate.com>