

## MILLIOHM METER



## MILLIOHM METER MODEL 16502

The Chroma 16502 Milliohm Meter is Chroma's newest digital Milliohm Meter. With a basic accuracy of 0.05% the instrument offers a  $0.001\text{m}\Omega \sim 1.9999\text{M}\Omega$  wide measurement range. It provides measurement range with 4 1/2 digits resolution. The fast measurement time is 65 ms. It suits component evaluation on production line.

The Chroma 16502 Milliohm Meter provides three kinds of mode for the different material applications. Pulsed test current output mode is used to reduce thermal EMFs affection on milliohm measurement. DC test current output mode is used to fasten measurement speed for inductive DUT. Dry-circuit test current output mode is used to measure such contact resistances where the maximum open-circuit voltage must be limited to 20mV. DC, Pulsed, and Dry-circuit test current driving modes, enable the Chroma 16502 can be properly used in DC resistance measurement for various inductive components (coil, choke, and transformer winding etc.), cable, metallic contact (connector, relay switch etc.) and conduction materials.

The Chroma 16502 provides temperature correction function. Temperature correction (TC function) without regarding to material or temperature. Users usually get different resistance value with different ambient temperature. Conventional units have the temperature correction using a copper wire at 20 °C only, but 16502 provides the converted values regardless of material or temperature.

The Chroma 16502 offers temperature conversion function. It is helpful temperature conversion function for motor / coil evaluation. Users usually should not take the motor / coil temperature through touch the surface directly when the motor just stops. The temperature conversion function shows the temperature (t) or increase in temperature ( $\Delta t$ ) of motor / coil, deriving the values from the measured resistance of the motor / coil and the ambient temperature. It is helpful for user to do the temperature evaluation of motor / coil.

The Chroma 16502 provide the menu list on front panel of LCD Display, and the programming assure that low resistance measurements can be made quick and easy. Provides a programmable Hi/Lo comparator function in absolute value or %, as well as 8 sorting bins for categorization of components.

For measurement integrity, contacting to the test device is made via a 4-terminal Kelvin connection that incorporates an automatic zeroing function to compensate for lead errors.

Standard RS232 interface, optional GPIB & Handler interface, high speed and stable measurement capabilities enable Chroma 16502 can be used for both component evaluation on the production line and milliohm measurement for bench-top applications.

## MODEL 16502

### Key Features

- Basic accuracy : 0.05%
- Pulsed test current output mode is used to reduce thermal EMFs affection on milliohm measurement
- DC test current output mode is used to fasten measurement speed for inductive DUT
- Dry-circuit test current output mode (limited Max. 20mV) is used to measure such contact resistances where the maximum open-circuit voltage must be limited to 50mV
- Temperature correction (TC function) regardless of material or temperature
- Useful temperature conversion function for motor/ coil evaluation
- 4 channels R scan with balance check function for fan motor (combined with A165017 option)
- $0.001\text{m}\Omega \sim 1.9999\text{M}\Omega$  wide measurement range with 4½ digits resolution
- Standard RS-232 interface
- Optional GPIB & Handler interface
- Bin-sorting function
- Comparator and pass/fail alarming beeper function
- Large LCD display (240 x 64 dot-matrix)
- Friendly user interface
- LabView® Driver



**Chroma**



## FEATURES

### Dry Circuit

Dry circuit test limits open-circuit voltage level to avoid any damage on contact junction while initial of contact for contact resistance measurement. The Chroma 16502 limits this open-circuit voltage level to be lower than 20mV.

### R Scan

4 channels R scan with balance check function for fan motor (combined with A165017 option). Fan and motor are combined by multiple groups of coils and should be inter-balanced between coils or it may cause abnormal sound. Thus, test if the coils balance is needed. The 16502 provides R scan function plus option A165017 4 channels R scanner for customer test. For measurement more accuracy, the customer can use it with temperature compensation function. R Scan function should be coordinated with purchased option A165017 4 channels R scanner.

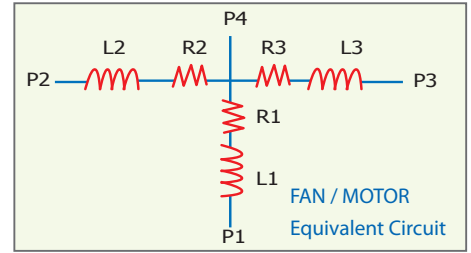

### Compare

Selection of comparator function ON and OFF. The limit can be set to single Upper or Lower, and both, depends on the test requirement. Two setting methods are available: absolute value (upper/lower limit setting) and relative value (% of a reference value), and judgment results, indicated by Hi, PASS or Lo and beeper, are also output via Handler I/F, RS-232 and GPIB interfaces.

### Bin Sorting

According to a preset range, measurements can be classified in up to ten ranks (BIN1 through BIN8, BIN0 and BIN OUT is over or lower limit). Settings are the same as for the comparator, using either absolute or relative values with results displayed and output to Handler I/F, RS-232 and GPIB interfaces.

### Meas. Delay

Delay time between the test signal start output and the measurement. Generally used for DUT needs more time for charge. For some large inductance component testing, trigger delay time must be set to delay the measurement start point till test current is ready.

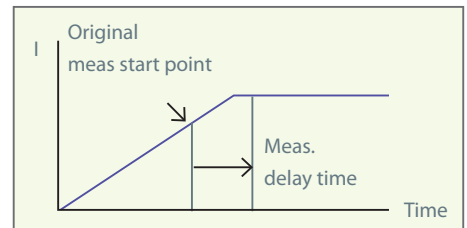

Measurement Delay

### Trig. Delay

Delay time between the test start and the external trigger. Generally used for automatic equipment timing adjustment or delay time for waiting a real leakage current.

### Null

Eliminates the measurement error caused by leakage current of outside test jigs and offset voltage of inside circuit.

### Average

Measurement values can be averaged to minimize display instability. The display shows the average value over a period. The number of samples to average can be set from 01 to 10.

### Power Noise Filter

The measurement of micro current is easily interfered by power noise. The Chroma 16502 used advanced power noise filtering technology to filter the selected line frequency noise accordingly for accurate measurement.

## TEST MODES

### DC Mode

Only one DC level of test current is output in this mode. This mode is proper to be used for inductive DUT measurement which is faster because of just one level measurement.

### Pulse Mode

Some contain medium or junctions between wires of different metals act like thermocouples generating small electric potentials called thermoelectric EMFs. Unless rejected in some way, the thermoelectric EMFs can interfere with the measurement.

A pulsed mode selecting in the Chroma 16502 includes pulsed+, pulsed-, and pulsed±. This mode is used to eliminate the affection of thermoelectric EMFs, and is proper to be used for low resistance measurement and conduction materials thermal characteristic analysis.

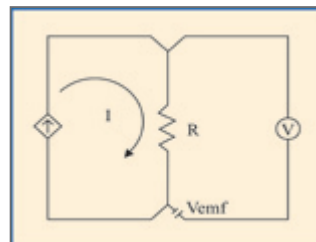

$V_{emf} = \text{Thermoelectric EMFs}$

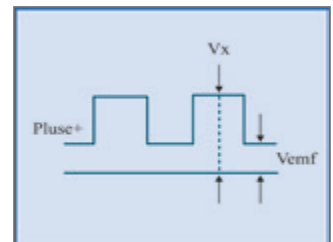

$V_x - V_{emf} = IR$   
 $V_{emf} = \text{Thermoelectric EMFs}$

## FOUR-TERMINAL RESISTANCE MEASUREMENTS

### For Measurements Unaffected by Test Leads or Contact Resistance

With two-terminal measurements, the conductor resistance of the test leads and the contact resistance of the connections are included in the measured resistance, resulting in measurement errors. The four-terminal measurement method employs a very high input impedance voltmeter, whereby almost all measurement current is conducted through measured resistance R. By measuring the voltage drop across only R, its resistance is measured without being significantly affected by R1 to R4.

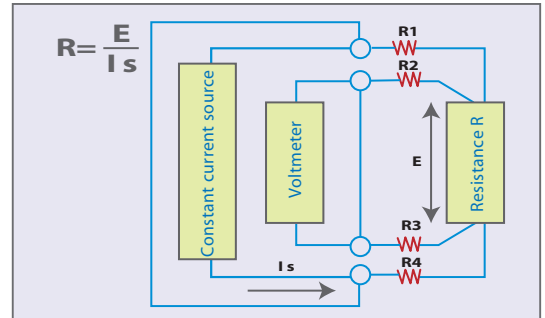

Values R1 through R4 are the combined resistances of the test leads and contact resistance

## TEMPERATURE COMPENSATION

Using the Chroma A165015 temperature probe with temperature function interface card (A165013/A165014), Chroma 16502 is possible to correct the displayed resistance value to the required temperature by any thermal coefficient. A lot of material's resistance will be different value by the different ambient temperature. This function avoids that users complex calculation and calculation error. Conventional units have temperature correction using a copper wire at 20 °C, but the 16502 provides converted values regardless of material or temperature. Chroma 16502 supports two common types of temperature probe, PT100 and PT 500. Users just plug the temperature probe in the interface card with temperature function at back panel. Users also can key in the ambient temperature without the temperature probe to get temperature correction.

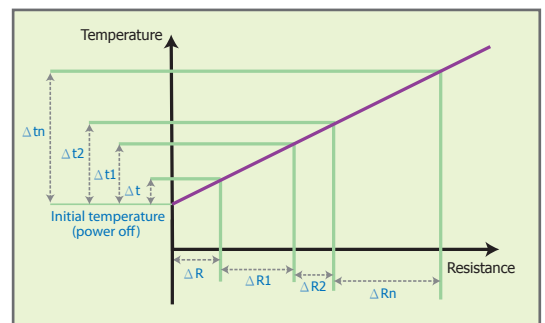

Temperature Correction

## HELPFUL TEMPERATURE CONVERSION FUNCTION FOR MOTOR / COIL EVALUATION

Using the Chroma A165015 temperature probe with temperature function interface card (A165013/A165014), Chroma 16502 is possible to display the temperature (t) or increase in temperature ( $\Delta t$ ) of an object, deriving the values from the measured resistance of the object and the ambient temperature. Chroma 16502 supports two common types of temperature probe, PT100 and PT 500. Users just plug the temperature probe in the interface card with temperature function at back panel.

This function is especially useful for verifying motor windings or coils, where the maximum temperature increase needs to be determined when current is applied. It is also possible to use the calculated value for making comparisons. When evaluating motors and coils, it is necessary to confirm the maximum temperature increase that will occur while power is applied to the component. this function makes it easy to estimate the maximum temperature. The temperature conversion function can not be used at the same time as the temperature compensation function.

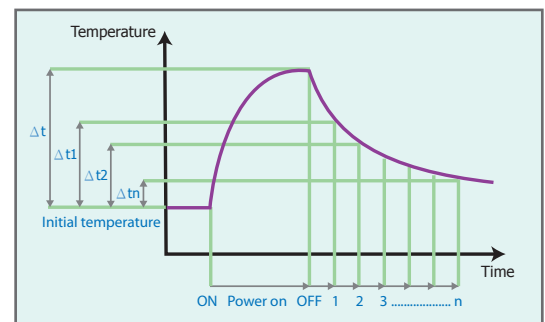

Temperature Conversion

## APPLICATIONS

- Production testing of contact resistance of switches, relays, connectors, cables, and other low Resistance Devices
- Production testing of various inductive components (coil, choke, and transformer winding etc.)
- Testing of low value resistors, fuses, squibs, and heating elements
- Winding resistance of motors, transformers, solenoids, and ballasts
- Conductivity evaluation in product design
- Incoming inspection and quality assurance testing



A165016



A165018



A165019

## SPECIFICATIONS

Model		16502
<b>Range Basic Measurement Accuracy *1; Test Current</b>		
20mΩ		± (0.1% of reading + 0.03 % of range) ; 1A typical
200mΩ		± (0.05% of reading + 0.03 % of range) ; 100mA typical
2Ω		± (0.05% of reading + 0.03 % of range) ; 10mA typical
20Ω		± (0.05% of reading + 0.03 % of range) ; 1mA typical
200Ω		± (0.05% of reading + 0.02 % of range) ; 1mA typical
2kΩ		± (0.05% of reading + 0.01 % of range) ; 1mA typical
20kΩ		± (0.1% of reading + 0.01 % of range) ; 100μA typical
200kΩ		± (0.2% of reading + 0.01 % of range) ; 10μA typical
2MΩ		± (0.3% of reading + 0.01 % of range) ; 1μA typical
<b>Test Signal</b>		
Drive Mode		DC+, DC-, Pulsed+, Pulsed -, Pulsed ±, Stand by
Dry Circuit		Open Circuit Voltage less than 20mV; for 200mΩ, 2Ω, 20Ω ranges only
<b>Measurement Time *2</b>		
Fast		65ms
Medium		150ms
Slow		650ms
<b>Temp. Correction / Conversion Function</b>		
Temp. Measurement Accuracy (Option)	-10.0°C ~ 39.9°C	± (0.3% of reading + 0.5°C) *3
	40.0°C ~ 99.9°C	± (0.3% of reading + 1.0°C) *3
Temp. Sensor Type (Option)		PT100/ PT500
<b>Interface &amp; I/O</b>		
Interface		RS-232(Standard) , GPIB, Handler (Optional)
Output Signal		Bin-sorting & Pass/Fail judge
Comparator		Upper/Lower limits in value
Bin Sorting		8 bin limits in %, ABS
Trigger Delay		0~9999ms
<b>Trigger</b>		Internal, Manual, External, BUS
<b>Display</b>		240 x 64 dot-matrix LCD display
<b>Correction Function</b>		Zeroing
<b>General</b>		
Operation Environment		Temperature : 10°C~40°C, Humidity : < 90 % R.H.
Power Consumption		80 VA max.
Power Requirement		90 ~ 132Vac or 180 ~ 264Vac, 47 ~ 63Hz
Dimension (H x W x D)		100 x 320 x 346 mm / 3.94 x 12.6 x 13.62 inch
Weight		4.2 kg / 9.25 lbs

**Note\*1** : 23 ± 5°C after Zeroing correction. Slow measurement speed. Refer to Operation Manual for detail measurement accuracy descriptions.

**Note\*2** : Measurement time includes sampling, calculation and judge test parameter measurement.

**Note\*3** : Not include temp. sensor accuracy

## PANEL DESCRIPTION

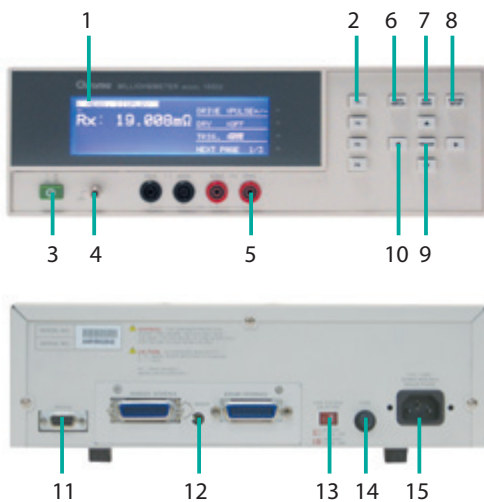

1. LCD Display
2. Function Keys
3. Power Switch
4. Ground Terminal
5. Measurement Terminals
6. Measurement Display Key
7. Main Index Key
8. System Setup Key
9. Trigger Key
10. Cursors Key
11. RS232 Interface
12. GPIB and Handler Interface with Temperature Compensation (A165013option)
13. Line Voltage Selector
14. Fuse
15. AC Line Input

## ORDERING INFORMATION

- 16502** : Milliohm Meter  
**A110235** : GPIB & Handler Interface  
**A110236** : 19" Rack Mounting Kit  
**A113012** : Vacuum Generator for A165018  
**A113014** : Vacuum Pump for A165018  
**A165013** : GPIB and Handler Interface with Temperature Compensation  
**A165014** : Temperature Compensation Card  
**A165015** : PT100 Temperature Probe  
**A165016** : Pin Type Leads (flat)  
**A165017** : 4 Channels R Scanner  
**A165018** : Test Fixture for SMD Power Choke  
**A165019** : Pin Type Leads (taper)  
**A165022** : Four Terminal Test Cable

Developed and Manufactured by :

**CHROMA ATE INC.**  
 致茂電子股份有限公司  
**HEADQUARTERS**  
 66 Hwaya 1st Rd., Kueishan  
 Hwaya Technology Park,  
 Taoyuan County 33383,  
 Taiwan  
 Tel: +886-3-327-9999  
 Fax: +886-3-327-8898  
 http://www.chromaate.com  
 E-mail: info@chromaate.com

**CHINA**  
**CHROMA ELECTRONICS**  
**(SHENZHEN) CO., LTD.**  
 8F, No.4, Nanyou Tian An  
 Industrial Estate, Shenzhen,  
 China PC: 518052  
 Tel: +86-755-2664-4598  
 Fax: +86-755-2641-9620

**JAPAN**  
**CHROMA JAPAN CORP.**  
 472 Nippa-cho, Kouhoku-ku,  
 Yokohama-shi, Kanagawa,  
 223-0057 Japan  
 Tel: +81-45-542-1118  
 Fax: +81-45-542-1080  
 http://www.chroma.co.jp  
 E-mail: info@chromaate.com

**U.S.A.**  
**CHROMA SYSTEMS**  
**SOLUTIONS, INC.**  
 19772 Pauling,  
 Foothill Ranch, CA 92610  
 Tel: +1-949-600-6400  
 Fax: +1-949-600-6401  
 http://www.chromausa.com  
 E-mail: sales@chromausa.com

**EUROPE**  
**CHROMA ATE EUROPE B.V.**  
 Morsestraat 32, 6716 AH Ede,  
 The Netherlands  
 Tel: +31-318-648282  
 Fax: +31-318-648288  
 http://www.chromaeu.com  
 E-mail: sales@chromaeu.com

Worldwide Distribution and  
 Service Network